



US00D558921S

(12) **United States Design Patent**
Schwartz et al.

(10) **Patent No.:** **US D558,921 S**
(45) **Date of Patent:** **** Jan. 1, 2008**

(54) **POUCH**

(75) Inventors: **Keara Elyse Schwartz**, Cincinnati, OH (US); **Robert Aaron Schroer**, West Chester, OH (US); **Frank William Denome**, Cincinnati, OH (US); **Scott Perng-Juin Liu**, Cincinnati, OH (US); **Ivan Anderson Huber**, Cincinnati, OH (US); **Gregory Marie Ulrich de Swarte**, Cincinnati, OH (US)

(73) Assignee: **The Procter & Gamble Company**, Cincinnati, OH (US)

(**) Term: **14 Years**

(21) Appl. No.: **29/271,321**

(22) Filed: **Jan. 16, 2007**

(51) **LOC (8) Cl.** **28-03**

(52) **U.S. Cl.** **D28/8.1**

(58) **Field of Classification Search** 510/147, 510/192, 194, 220, 221, 223, 224, 294, 298, 510/439, 440-442, 447-450; D28/4, 5, 8.1, D28/8.2; D24/101-103

See application file for complete search history.

(56) **References Cited**

U.S. PATENT DOCUMENTS

- D132,350 S * 5/1942 Stoner et al. D28/8.1
- D267,122 S * 11/1982 Scotton et al. D24/101
- D293,487 S * 12/1987 Swanson D28/8.1
- 4,746,452 A * 5/1988 Marek 510/449
- D352,364 S * 11/1994 Dietz D28/8.1
- D392,771 S * 3/1998 Mohary et al. D28/8.1

OTHER PUBLICATIONS

Trademark application 002040897, Jan. 15, 2001, OAMI-Online.*

* cited by examiner

Primary Examiner—Jennifer Rivard

(74) *Attorney, Agent, or Firm*—Laura R. Grunzinger

(57) **CLAIM**

The ornamental design for a pouch, as shown and described.

DESCRIPTION

FIG. 1 is perspective view of the first embodiment of the pouch;

FIG. 2 is a top view of the first embodiment of the pouch;

FIG. 3 is a bottom view of the first embodiment of the pouch;

FIG. 4 is a front view of the first embodiment of the pouch;

FIG. 5 is a back view of the first embodiment of the pouch;

FIG. 6 is a left view of the first embodiment of the pouch;

FIG. 7 is a right view of the first embodiment of the pouch;

FIG. 8 is a perspective view of a second embodiment of the pouch;

FIG. 9 is a top view of the second embodiment of the pouch;

FIG. 10 is a bottom view of the second embodiment of the pouch;

FIG. 11 is a front view of the second embodiment of the pouch;

FIG. 12 is a back view of the second embodiment of the pouch;

FIG. 13 is a left view of the second embodiment of the pouch; and,

FIG. 14 is a right view of the second embodiment of the pouch;

The broken lines immediately adjacent the shaded areas represent the bounds of the claim and all other broken lines are for illustrative purposes only. None of the broken lines form a part of the claimed design

1 Claim, 6 Drawing Sheets

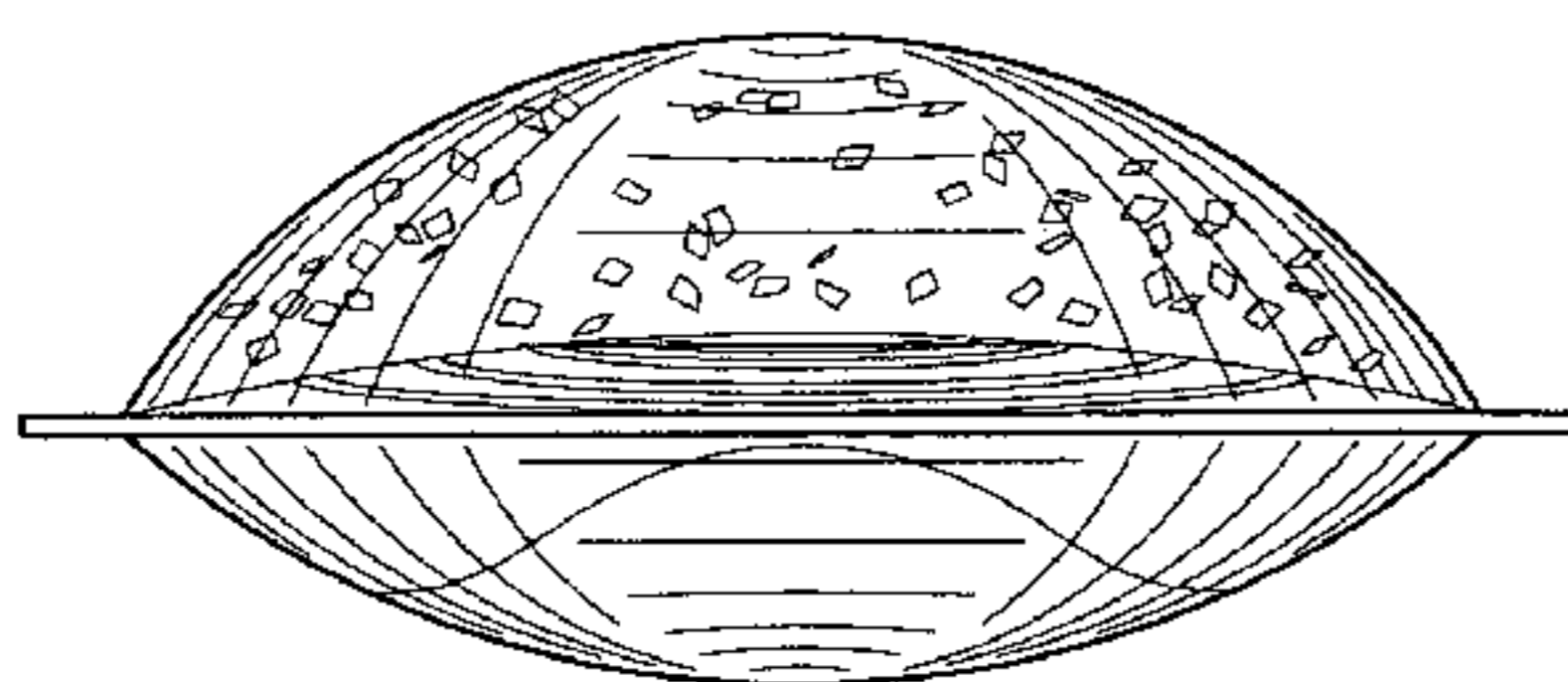
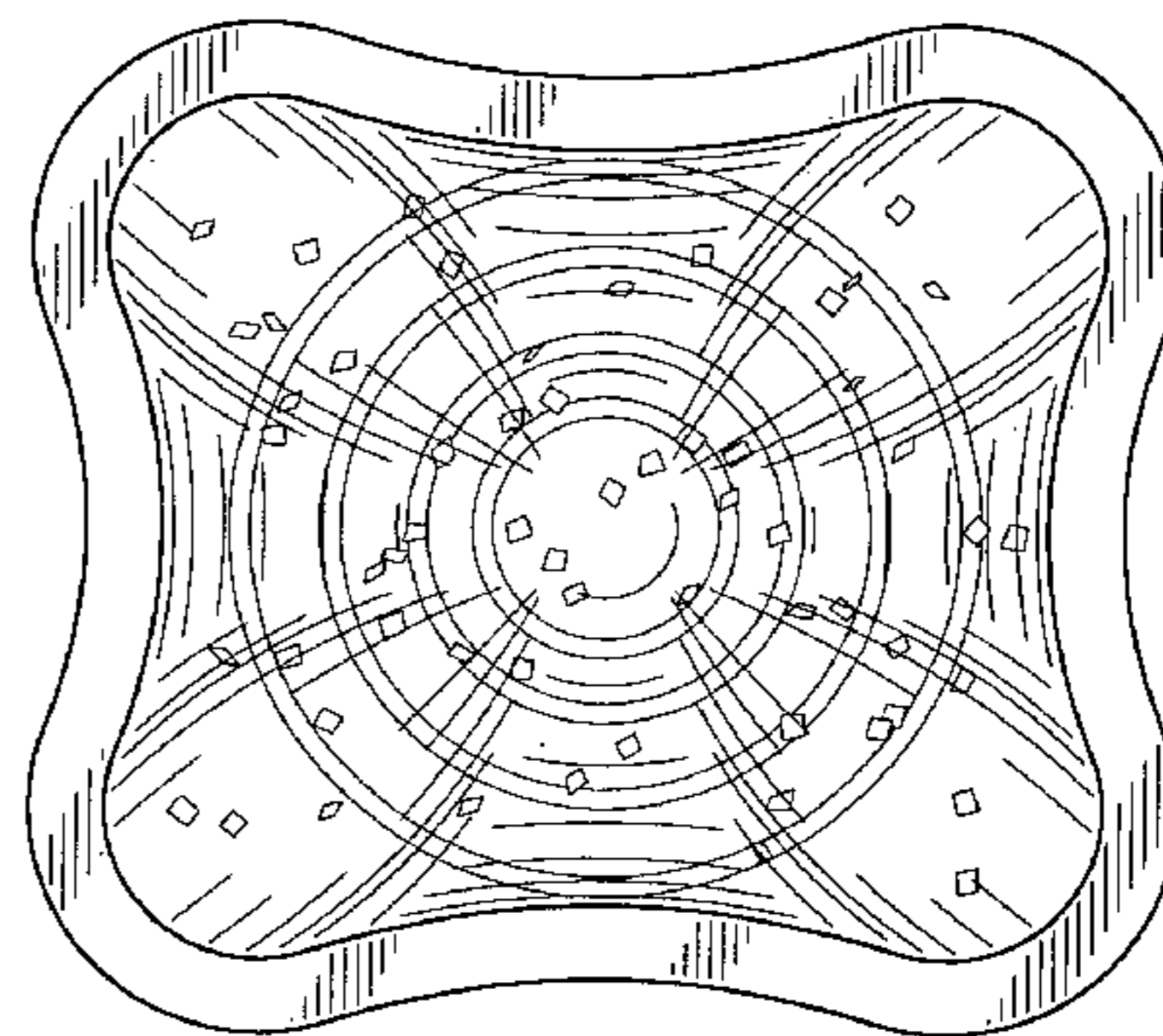
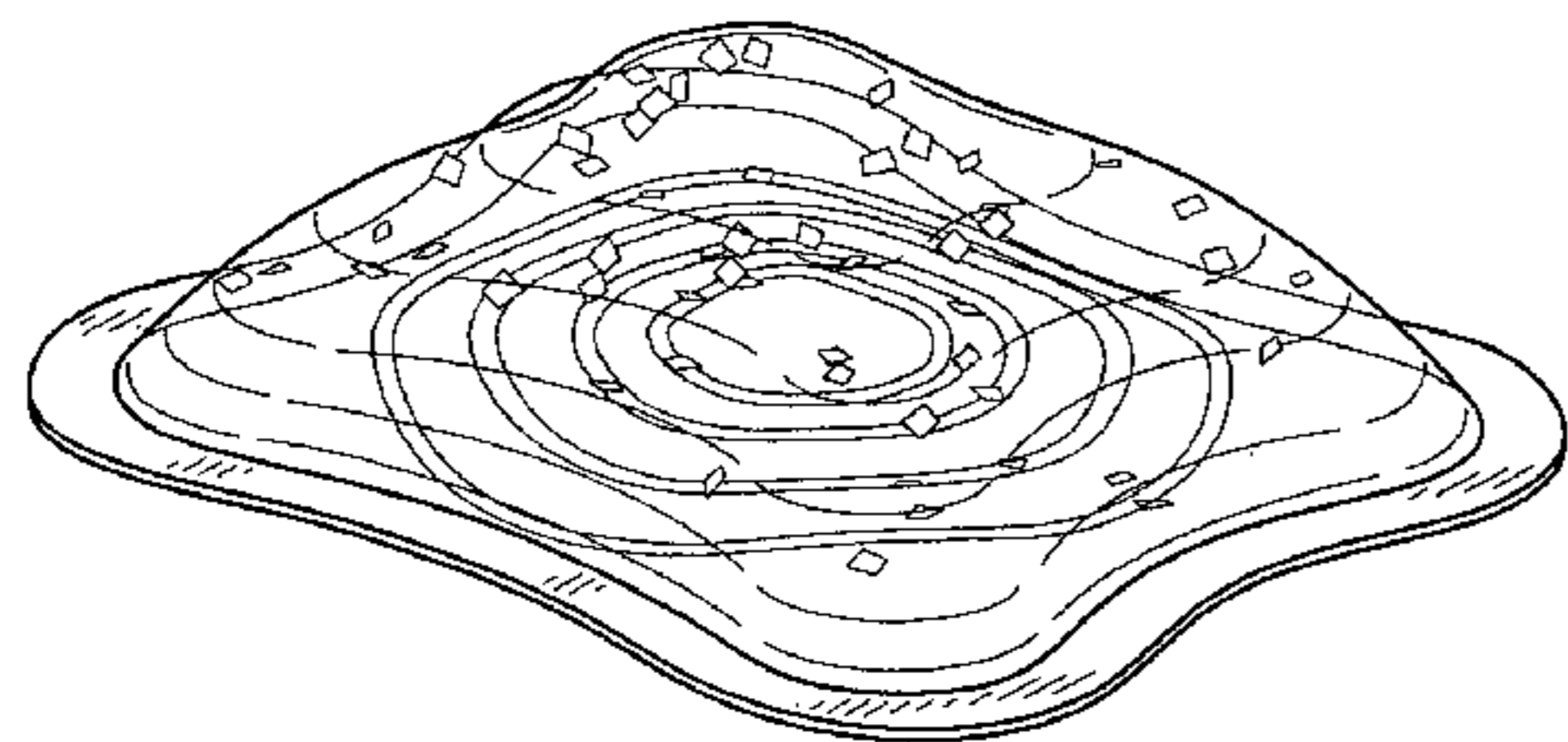

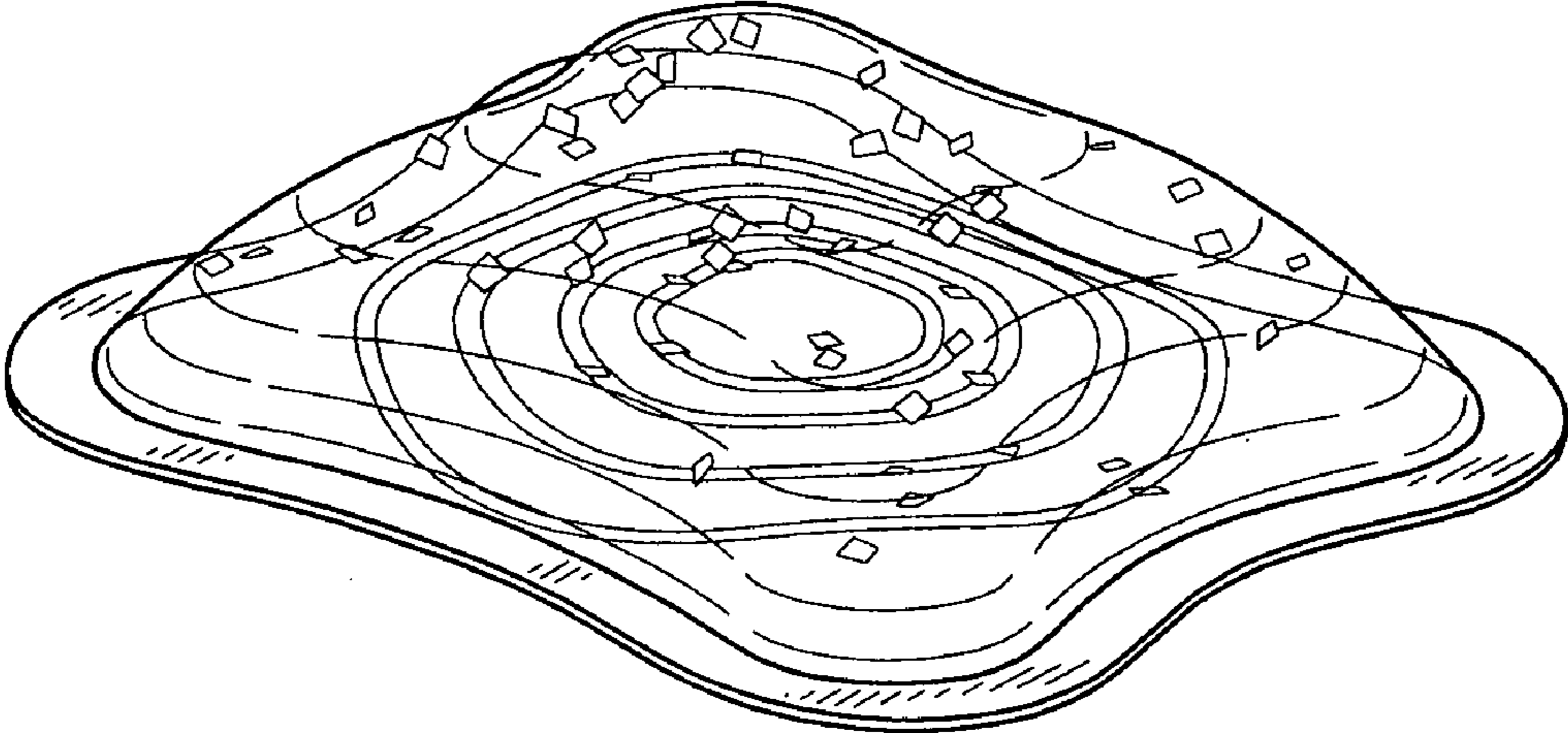

FIG. 1

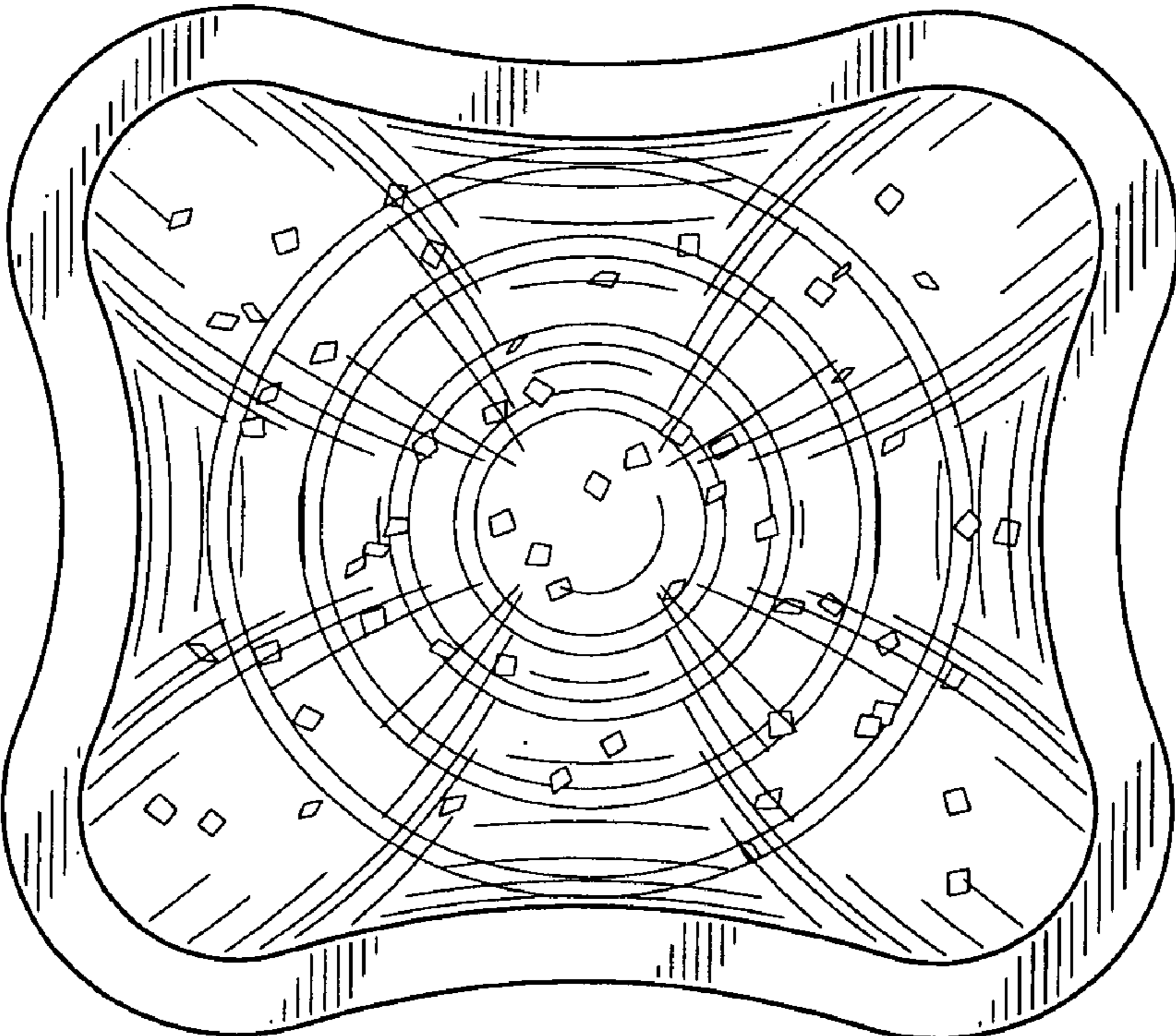

FIG. 2

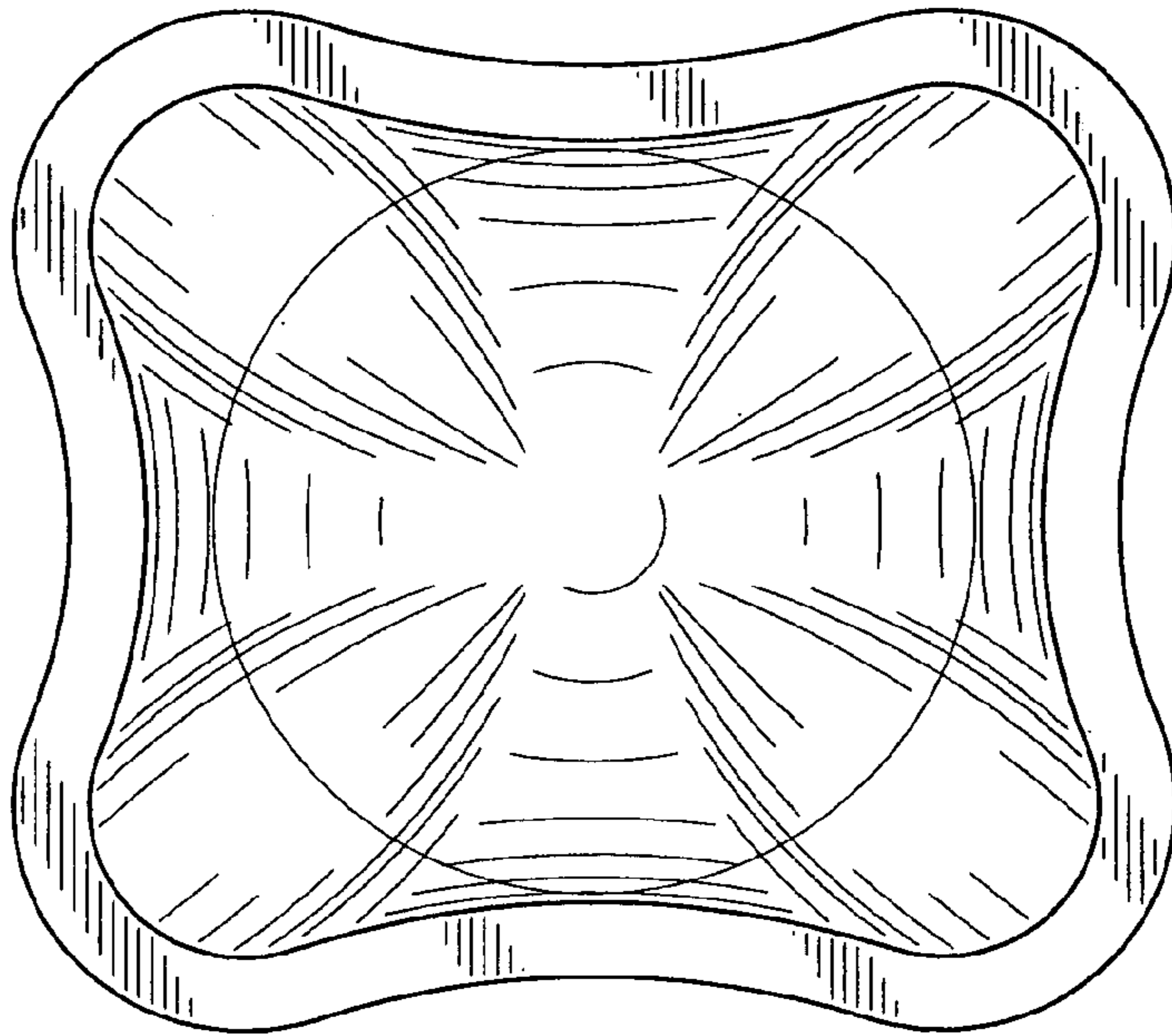

FIG. 3

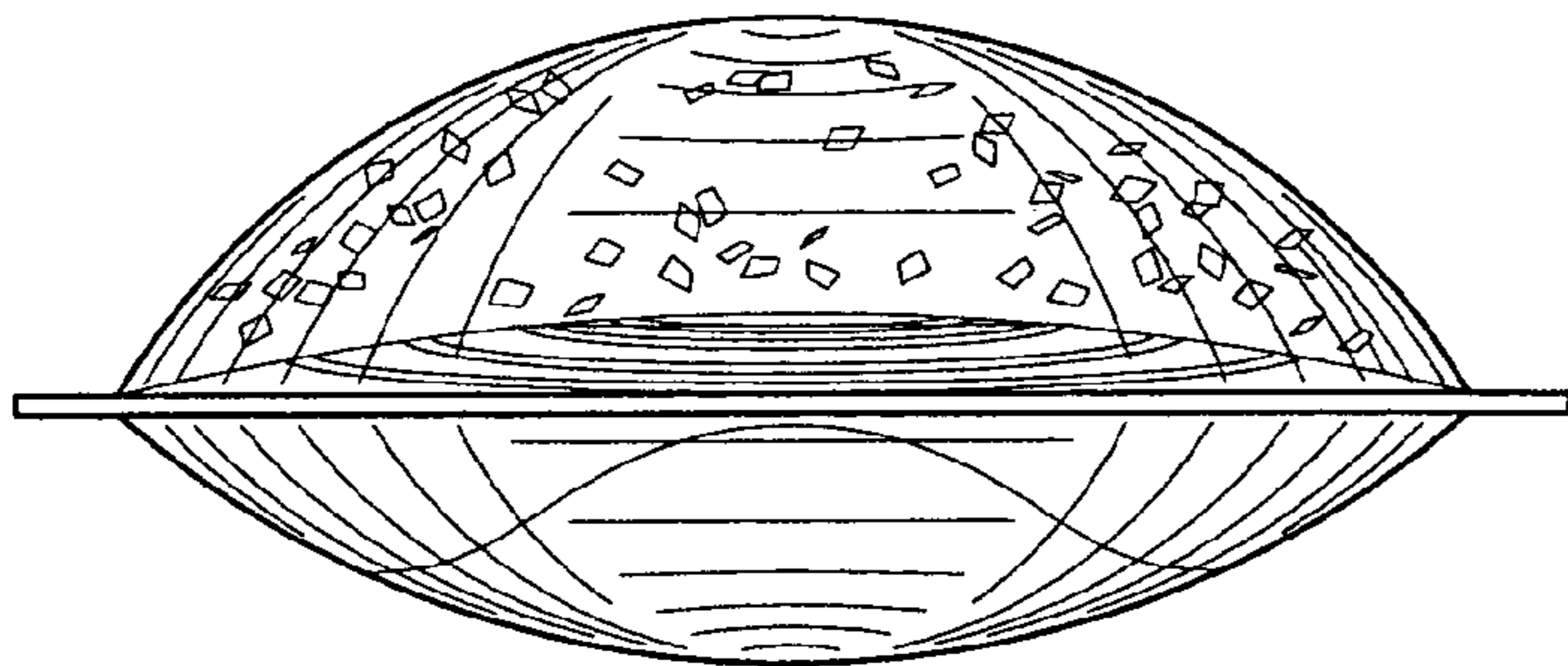

FIG. 4

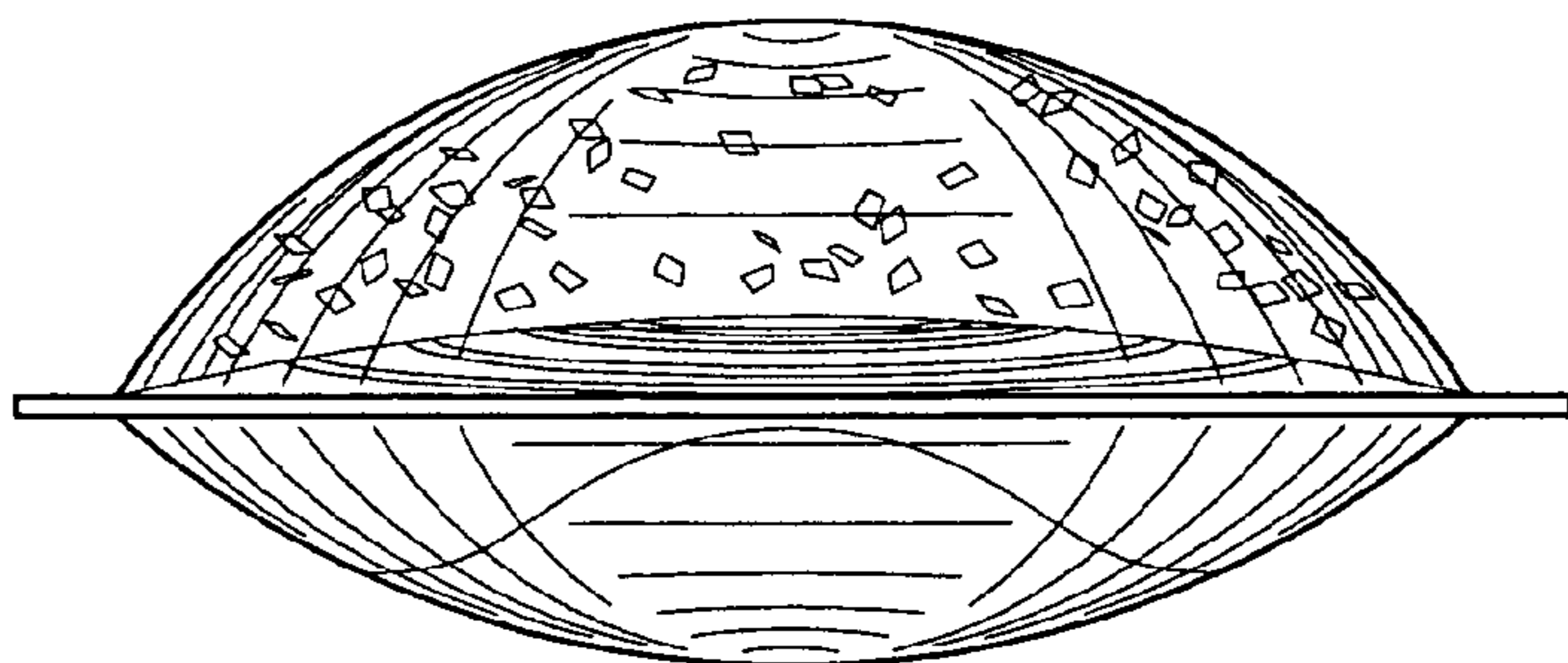

FIG. 5

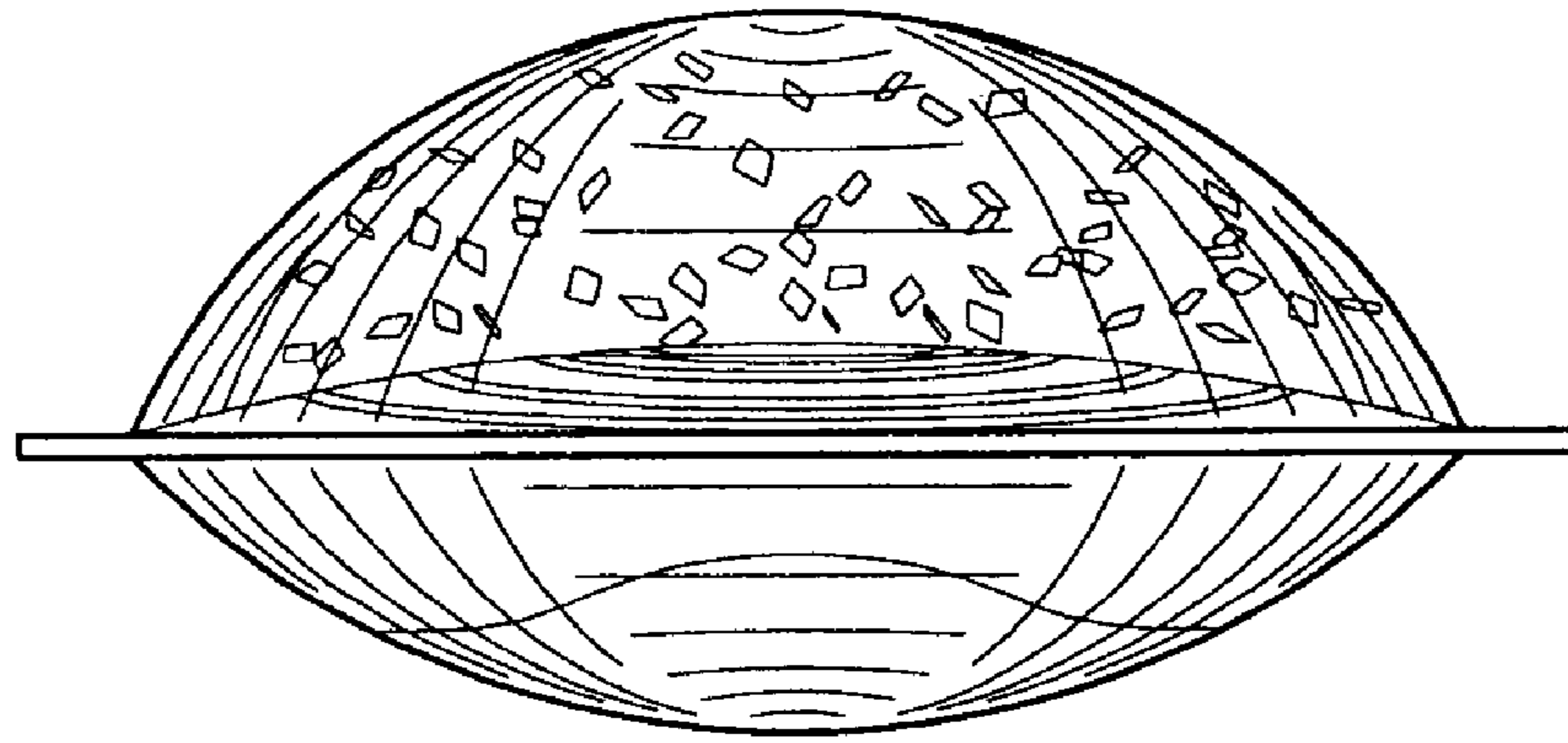

FIG. 6

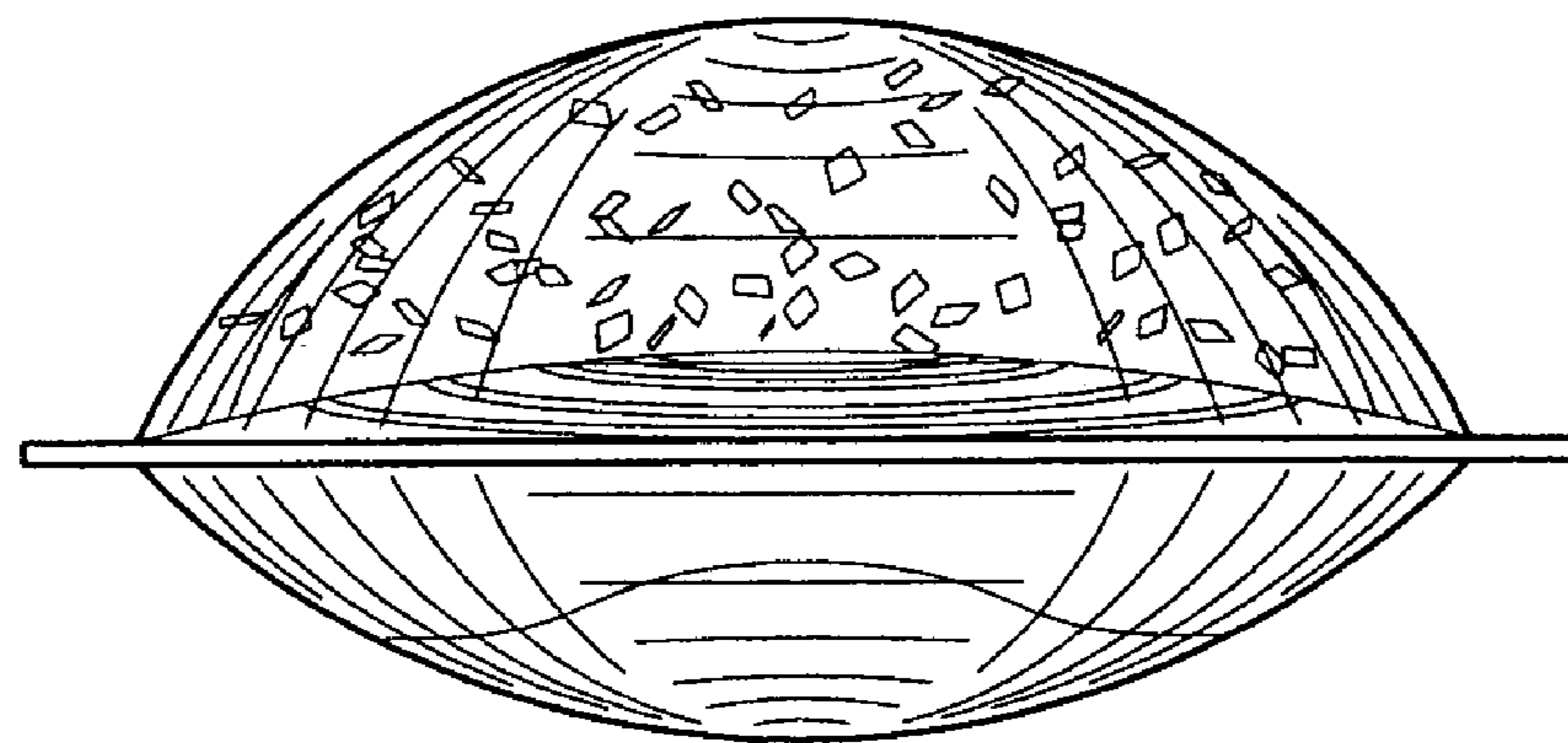

FIG. 7

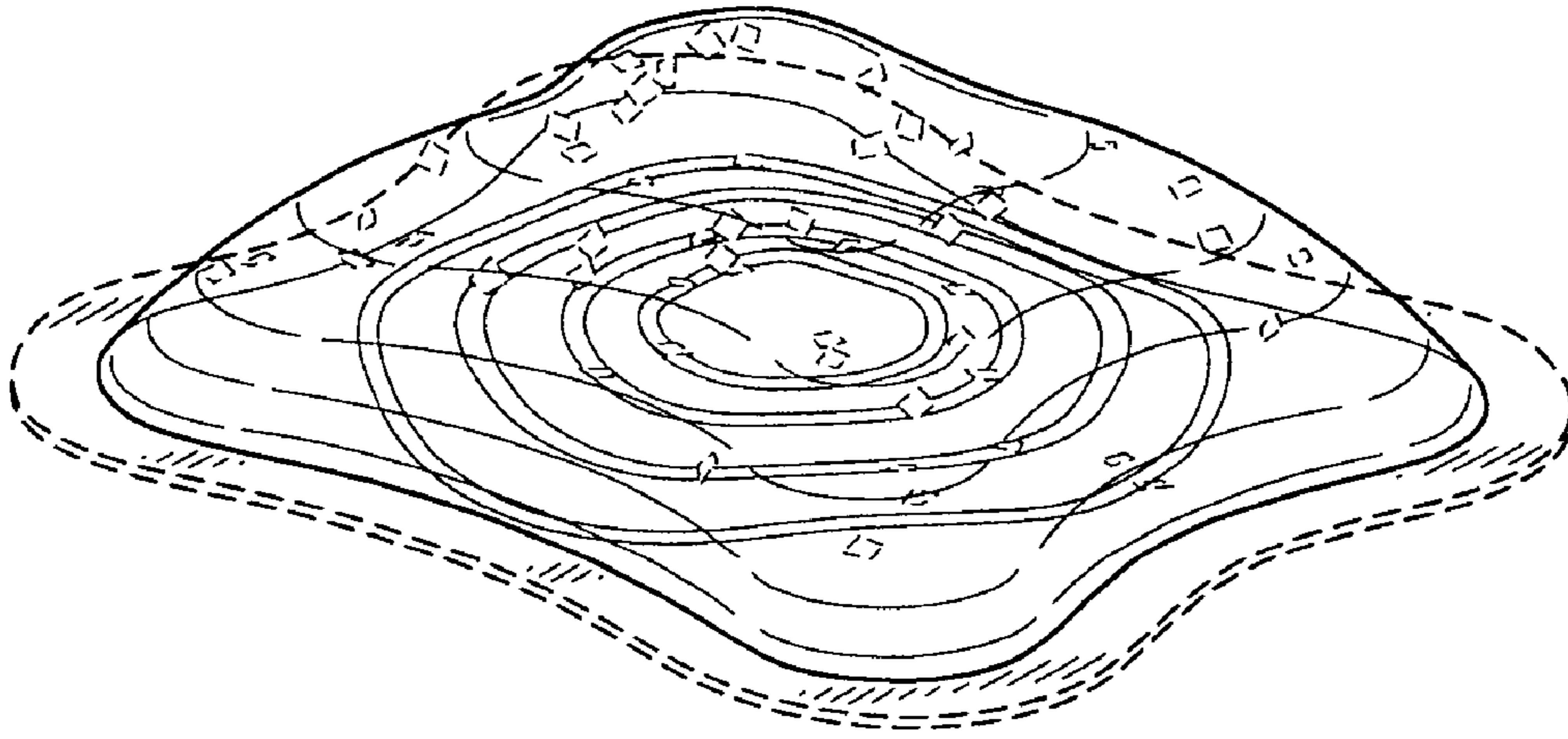

FIG. 8

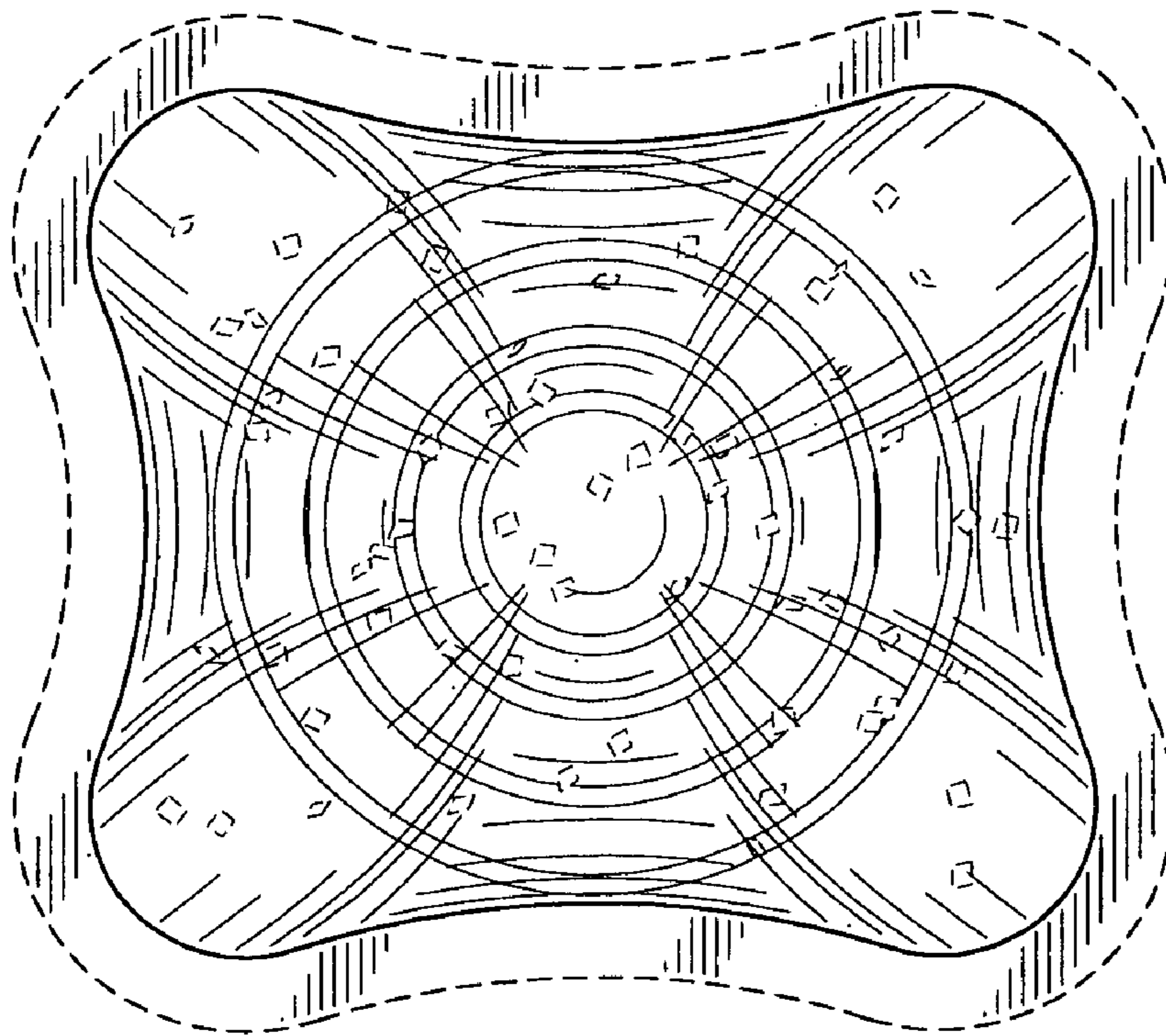

FIG. 9

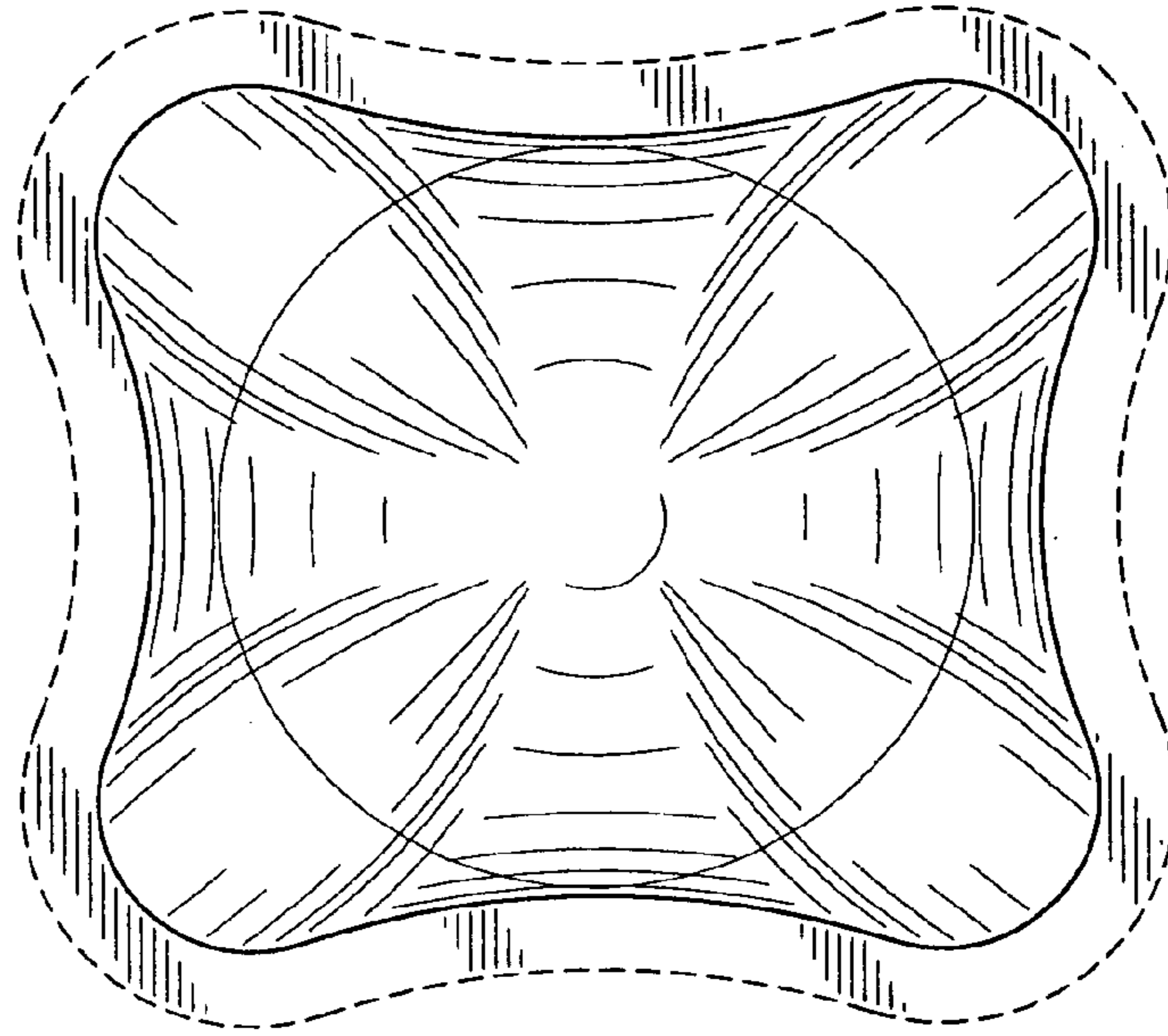

FIG. 10

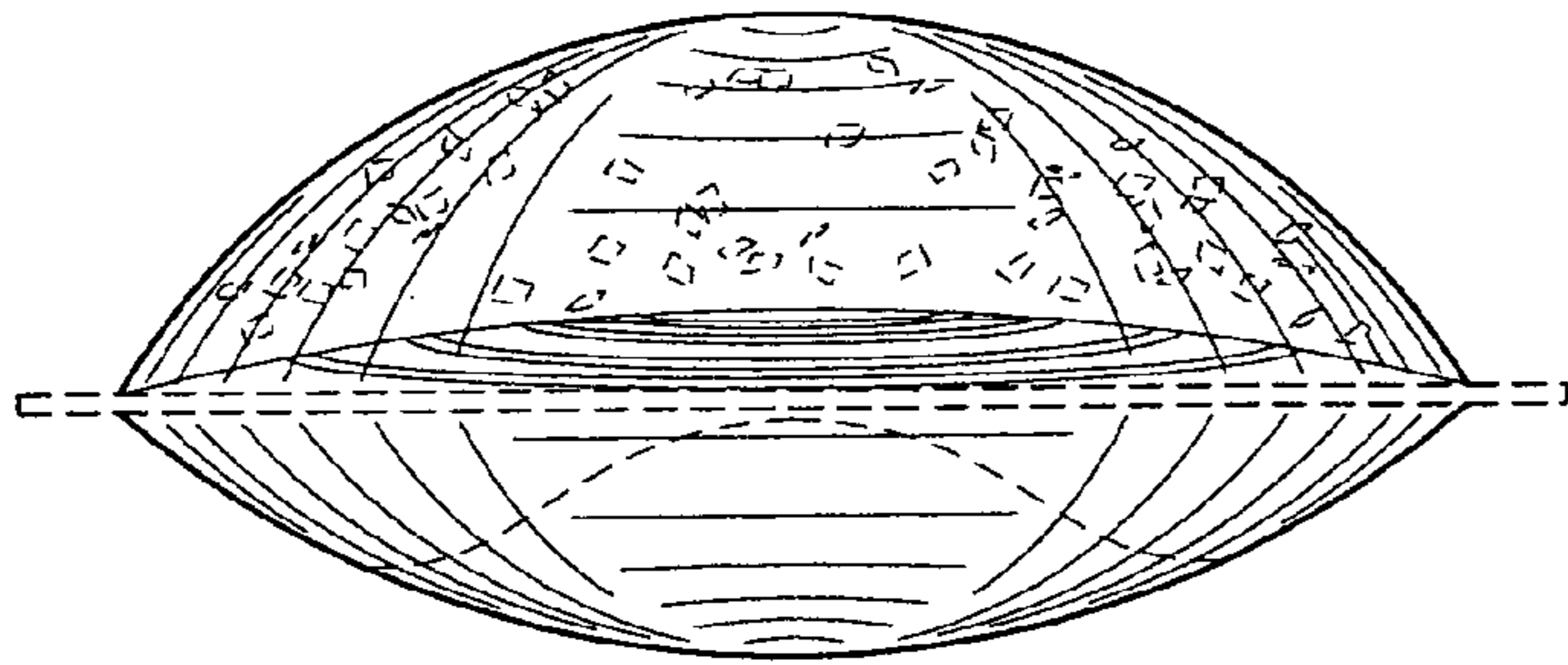

FIG. 11

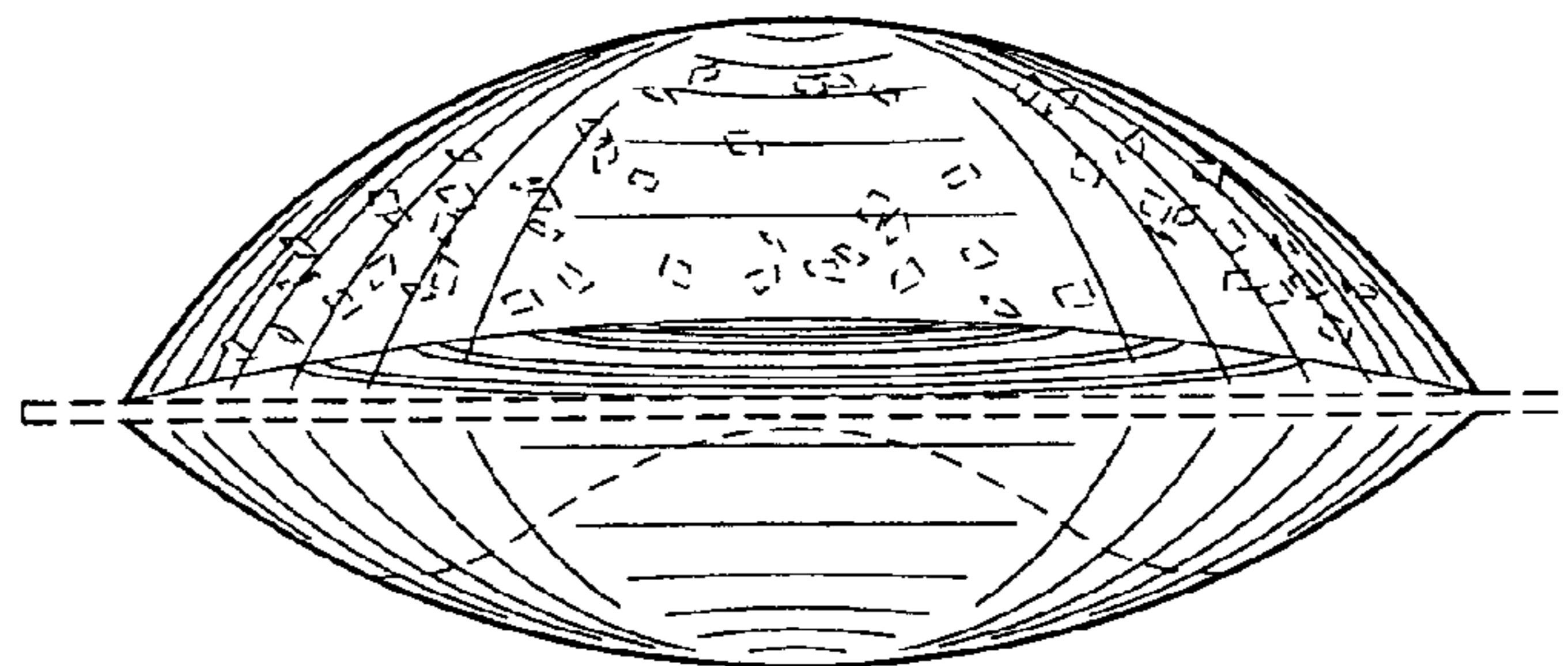

FIG. 12

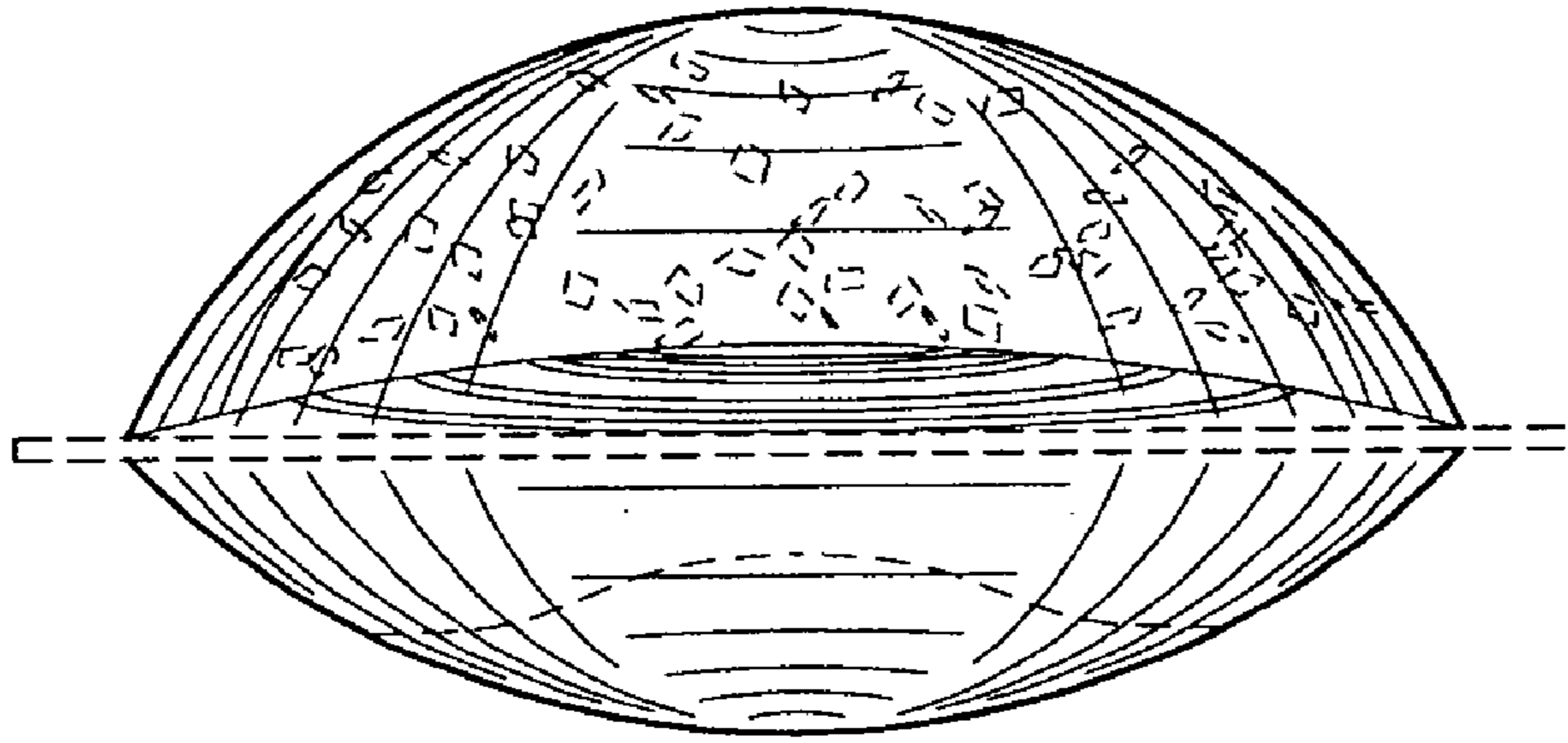

FIG. 13

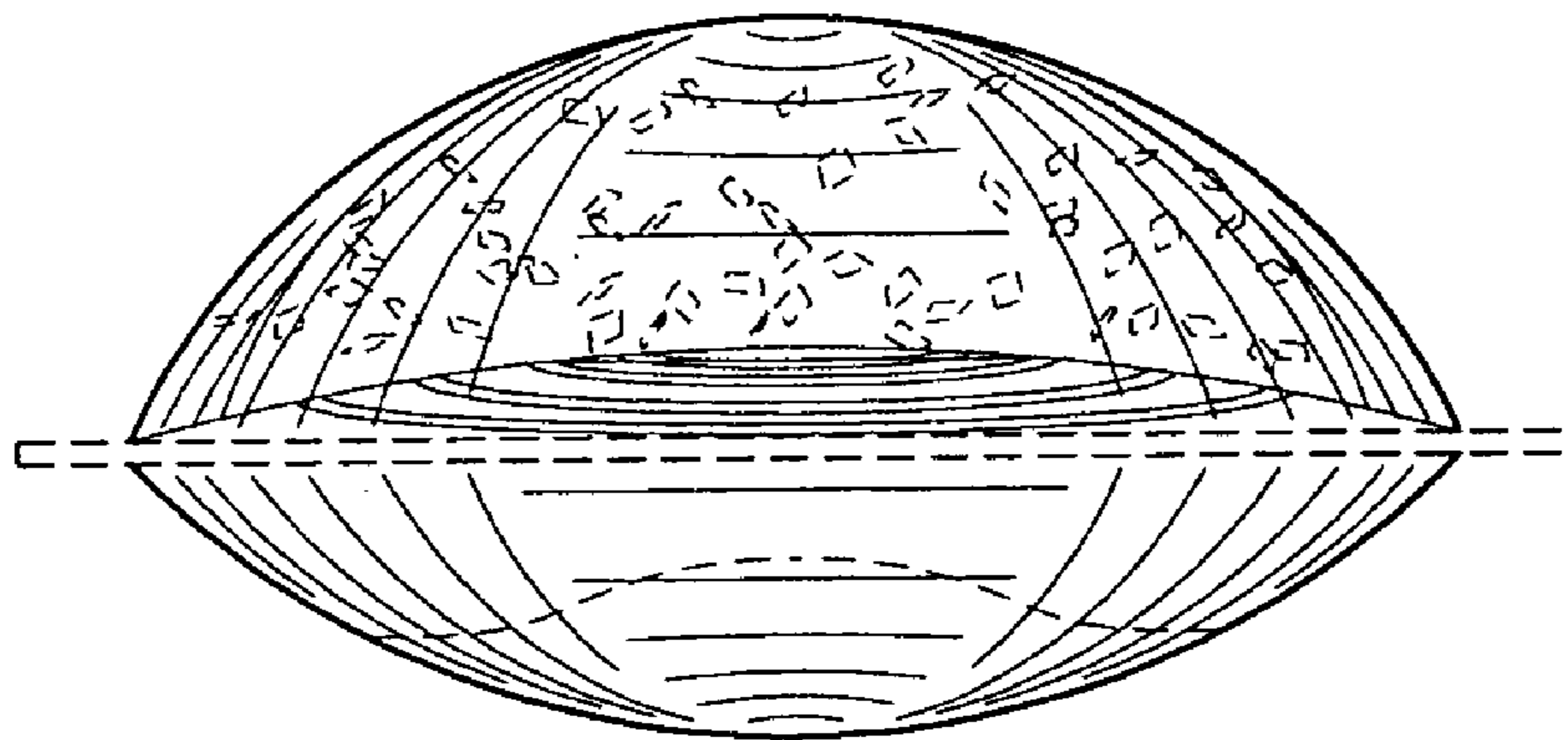

FIG. 14