



US00D558795S

(12) **United States Design Patent** (10) **Patent No.:** **US D558,795 S**
Saunders et al. (45) **Date of Patent:** **** *Jan. 1, 2008**

(54) **HANDHELD VACUUM PUMP UNIT**

(75) Inventors: **Craig M. Saunders**, Rocky River, OH (US); **Marc L. Vitantonio**, South Russell, OH (US); **Giles Douglas Powell, Jr.**, Richmond, VA (US); **Paul J. Tretina**, Glen Allen, VA (US)

(73) Assignee: **Alcoa Inc.**, Pittsburgh, PA (US)

(*) Notice: This patent is subject to a terminal disclaimer.

(**) Term: **14 Years**

(21) Appl. No.: **29/250,135**

(22) Filed: **Nov. 3, 2006**

(51) **LOC (8) Cl.** **15-02**

(52) **U.S. Cl.** **D15/7**

(58) **Field of Classification Search** D15/7-9;
D23/232, 231; 417/359, 415-416, 410.1,
417/321, 265, 405

See application file for complete search history.

(56) **References Cited**

U.S. PATENT DOCUMENTS

D248,396 S *	7/1978	Sendak	D15/7
D336,090 S *	6/1993	Lacorazza	D15/7
D348,677 S *	7/1994	Phillips et al.	D15/7
D358,397 S *	5/1995	Phillips et al.	D15/7
D405,097 S *	2/1999	Wong	D15/7
D415,500 S *	10/1999	Poon	D15/7
D425,912 S *	5/2000	Poon	D15/7
D451,521 S *	12/2001	Poon	D15/7
D464,976 S *	10/2002	Krieger et al.	D15/9
D467,048 S	12/2002	Masaki	
D467,593 S *	12/2002	Williams	D15/7
D467,941 S *	12/2002	Duncan	D15/7
D467,942 S *	12/2002	Duncan	D15/7
D525,823 S	8/2006	Littmann	

* cited by examiner

Primary Examiner—Ralf Seifert

(74) *Attorney, Agent, or Firm*—Greenberg Traurig, LLP; Paul F. McQuade; James Goepel

(57) **CLAIM**

The ornamental design for a handheld vacuum pump unit, as shown and described.

DESCRIPTION

FIG. 1 is a perspective view of the handheld vacuum pump unit, showing an embodiment of the present design comprising a curved rear panel;

FIG. 2 is a bottom plan view of the embodiment of the present design illustrated in FIG. 1;

FIG. 3 is a top plan view of the embodiment of the present design illustrated in FIG. 1;

FIG. 4 is a right elevation view of the embodiment of the present design illustrated in FIG. 1;

FIG. 5 is a left elevation view of the embodiment of the present design illustrated in FIG. 1;

FIG. 6 is a front elevation view of the embodiment of the present design illustrated in FIG. 1;

FIG. 7 is a rear elevation view of the embodiment of the present design illustrated in FIG. 1.

FIG. 8 is a perspective view of the handheld vacuum pump unit, showing an embodiment of the present design having a flat rear panel;

FIG. 9 is a bottom plan view of the embodiment of the present design illustrated in FIG. 8;

FIG. 10 is a top plan view of the embodiment of the present design illustrated in FIG. 8;

FIG. 11 is a right elevation view of the embodiment of the present design illustrated in FIG. 8;

FIG. 12 is a left elevation view of the embodiment of the present design illustrated in FIG. 8;

FIG. 13 is a front elevation view of the embodiment of the present design illustrated in FIG. 8; and,

FIG. 14 is a rear elevation view of the embodiment of the present design illustrated in FIG. 8.

1 Claim, 10 Drawing Sheets

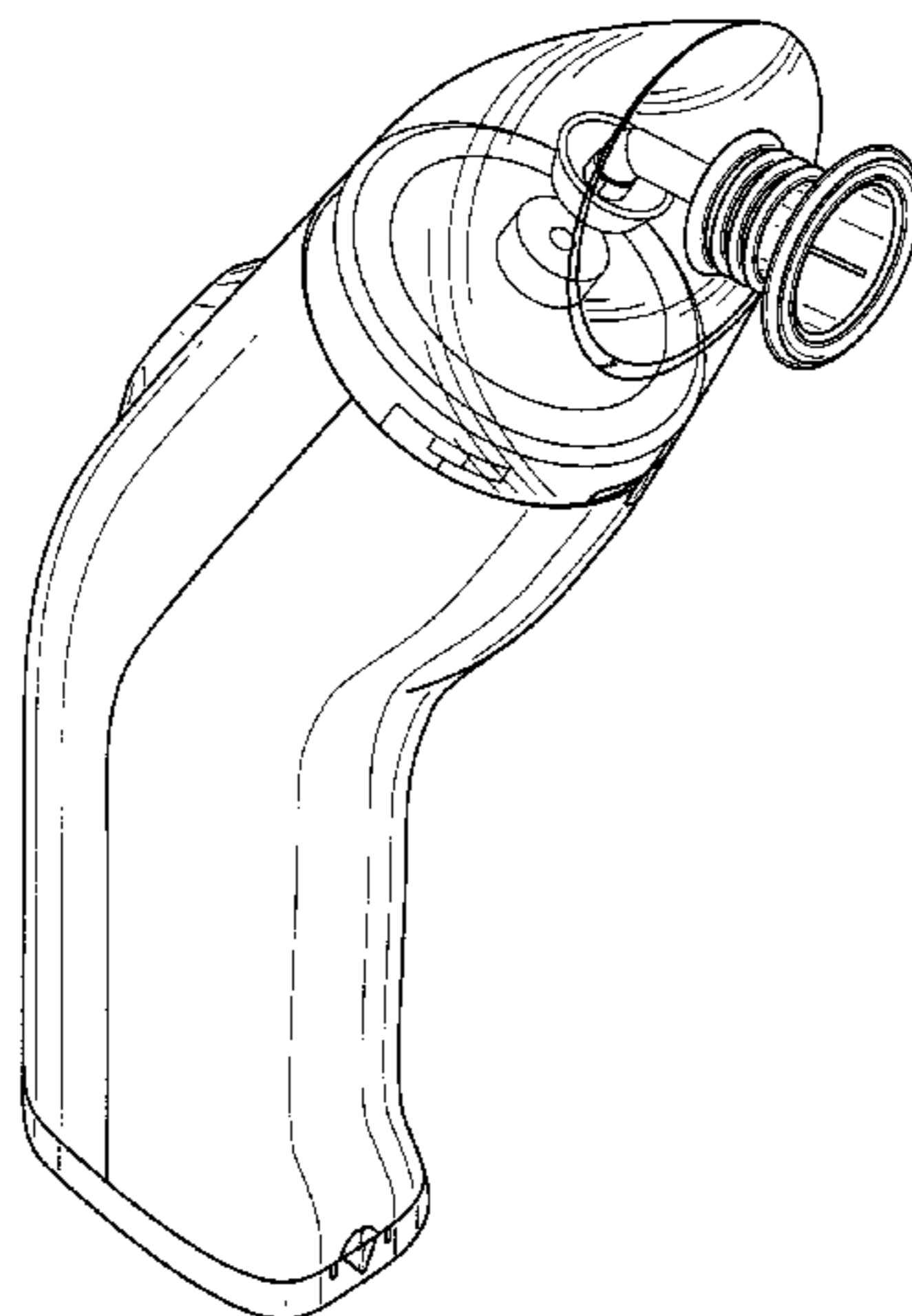

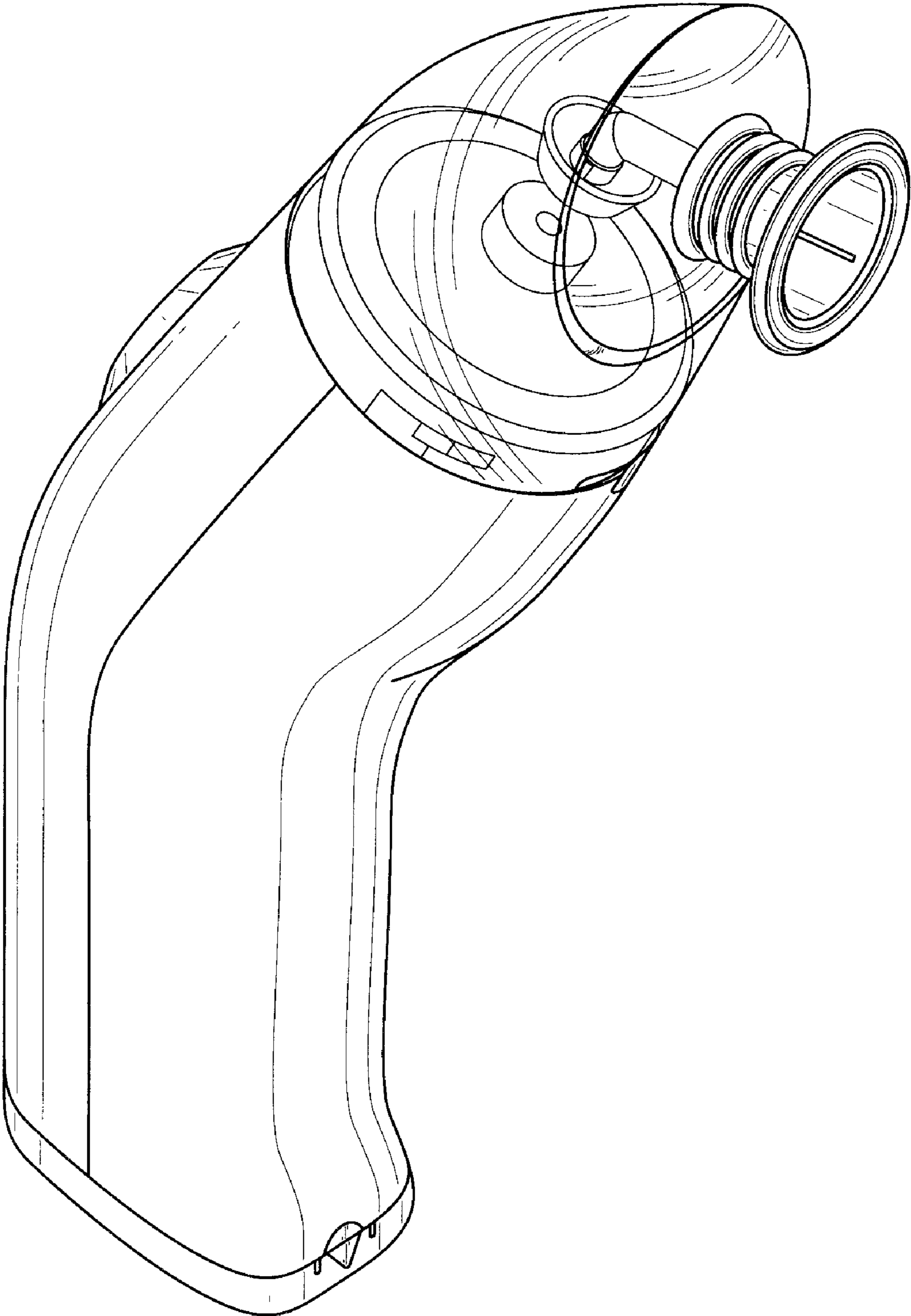

FIG. 1

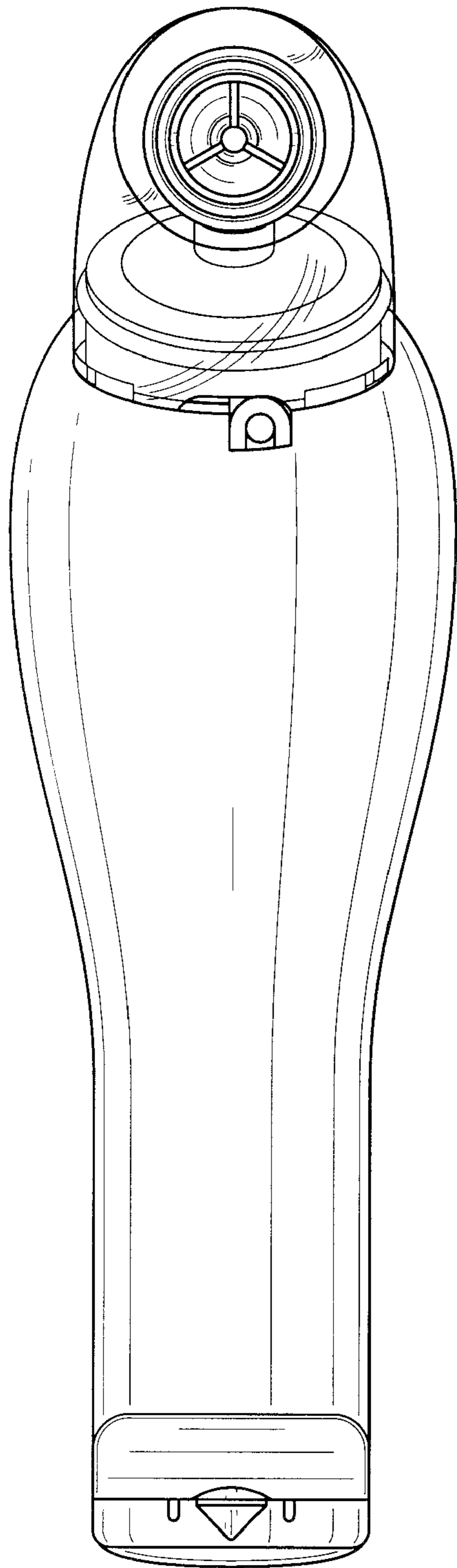

FIG. 2

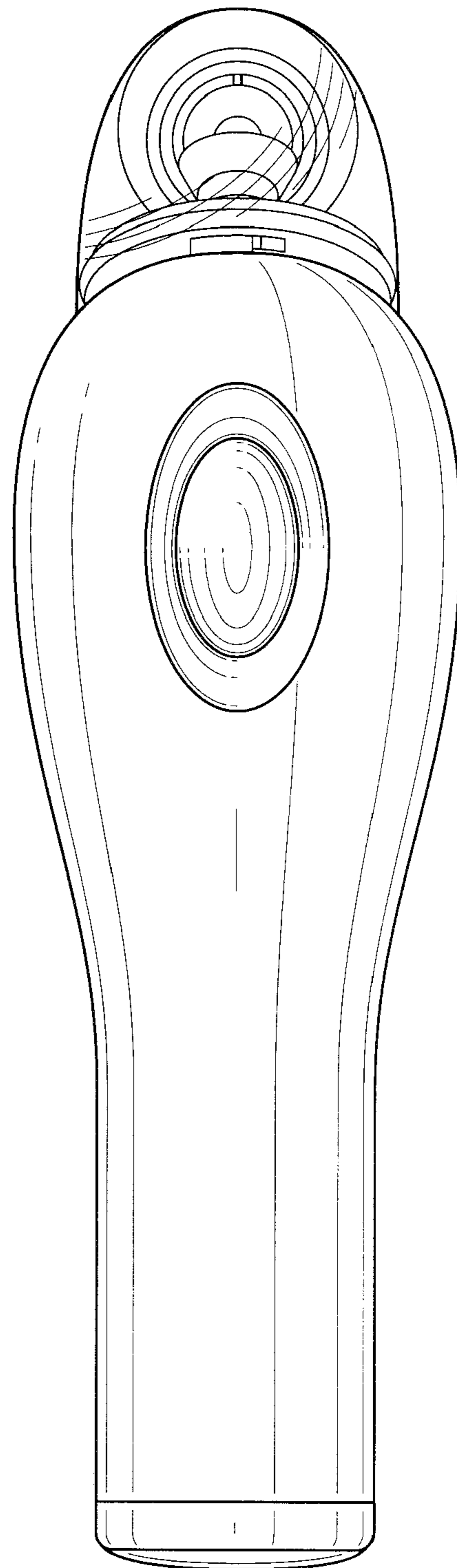

FIG. 3

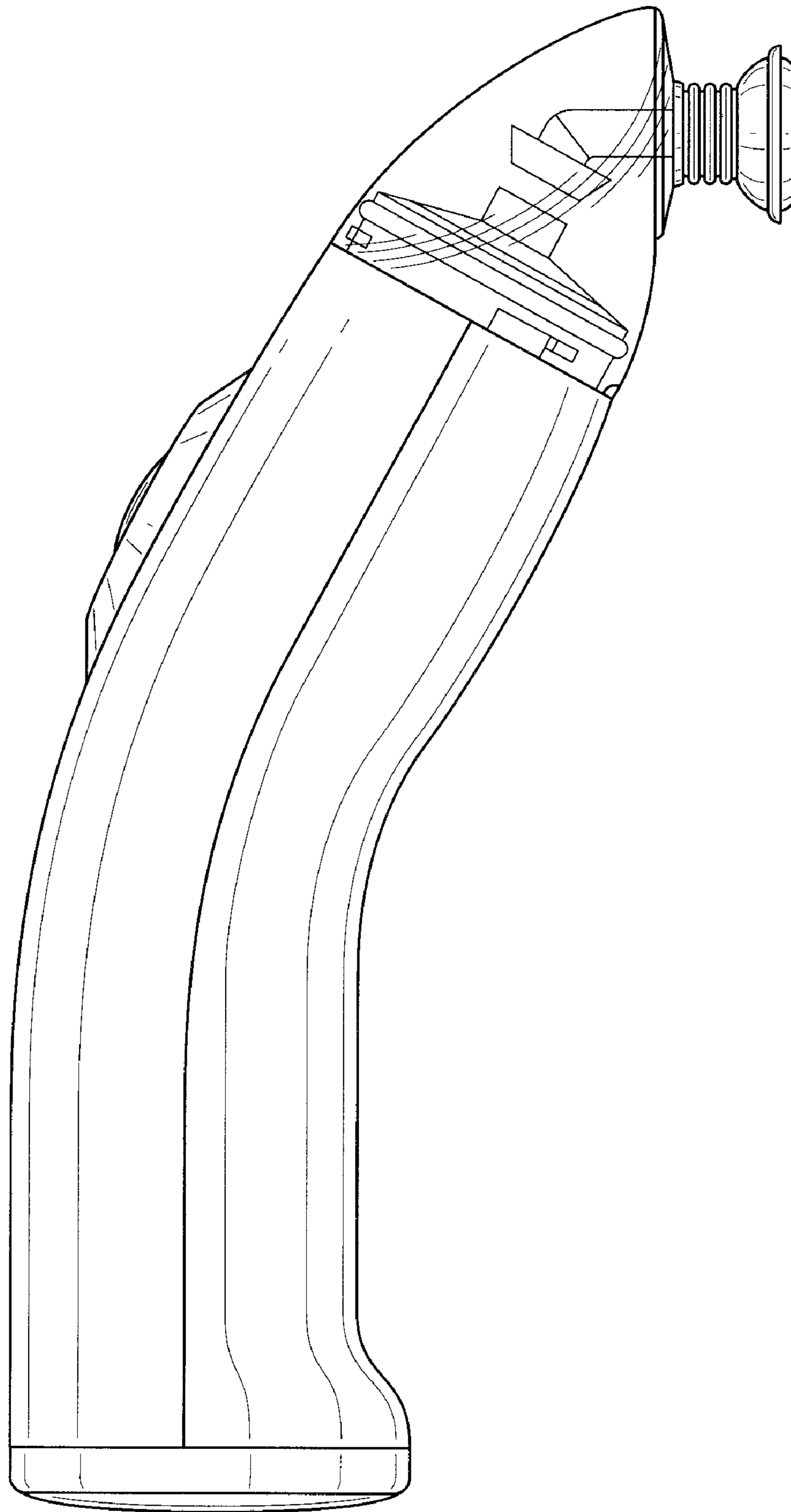

FIG. 4

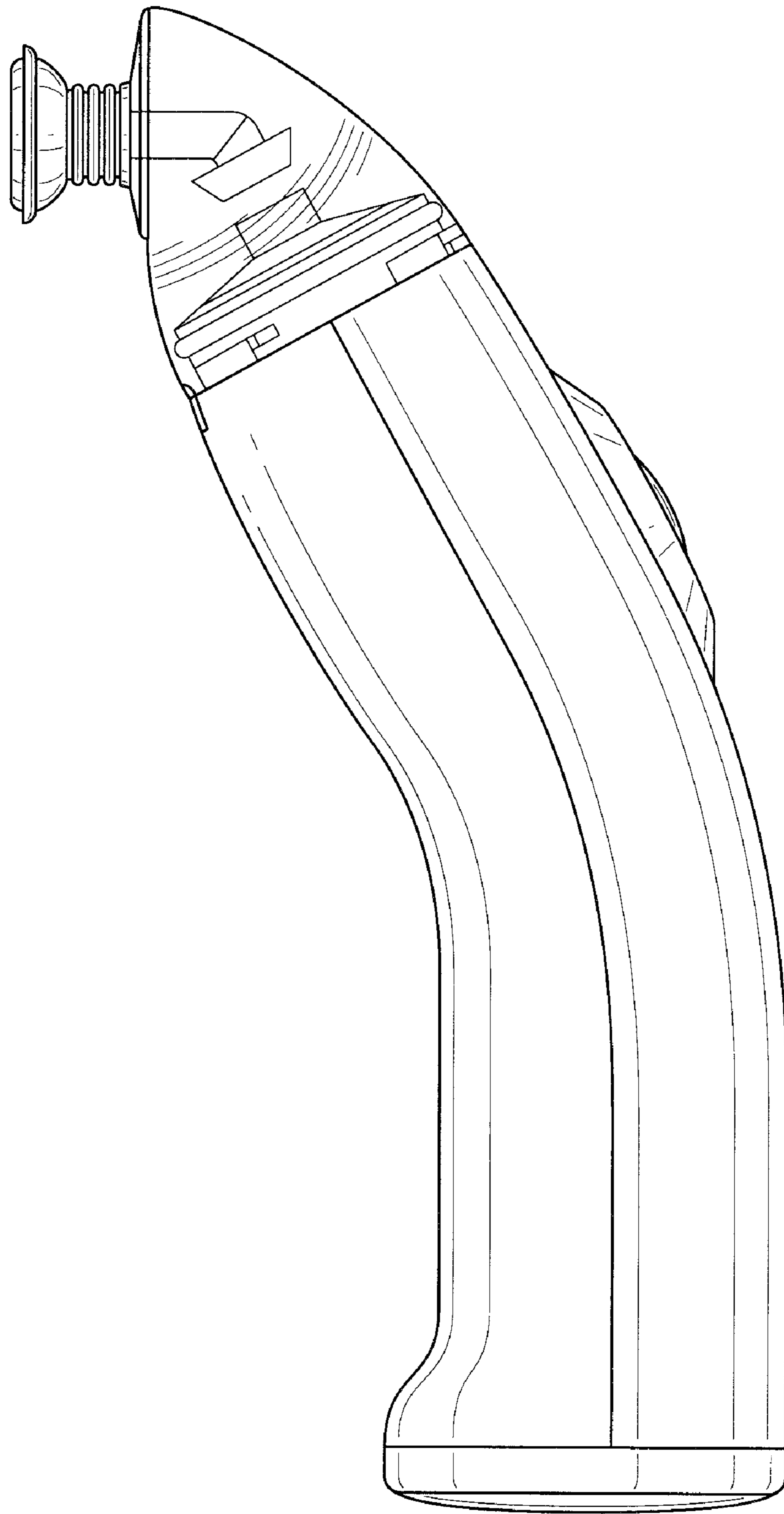

FIG. 5

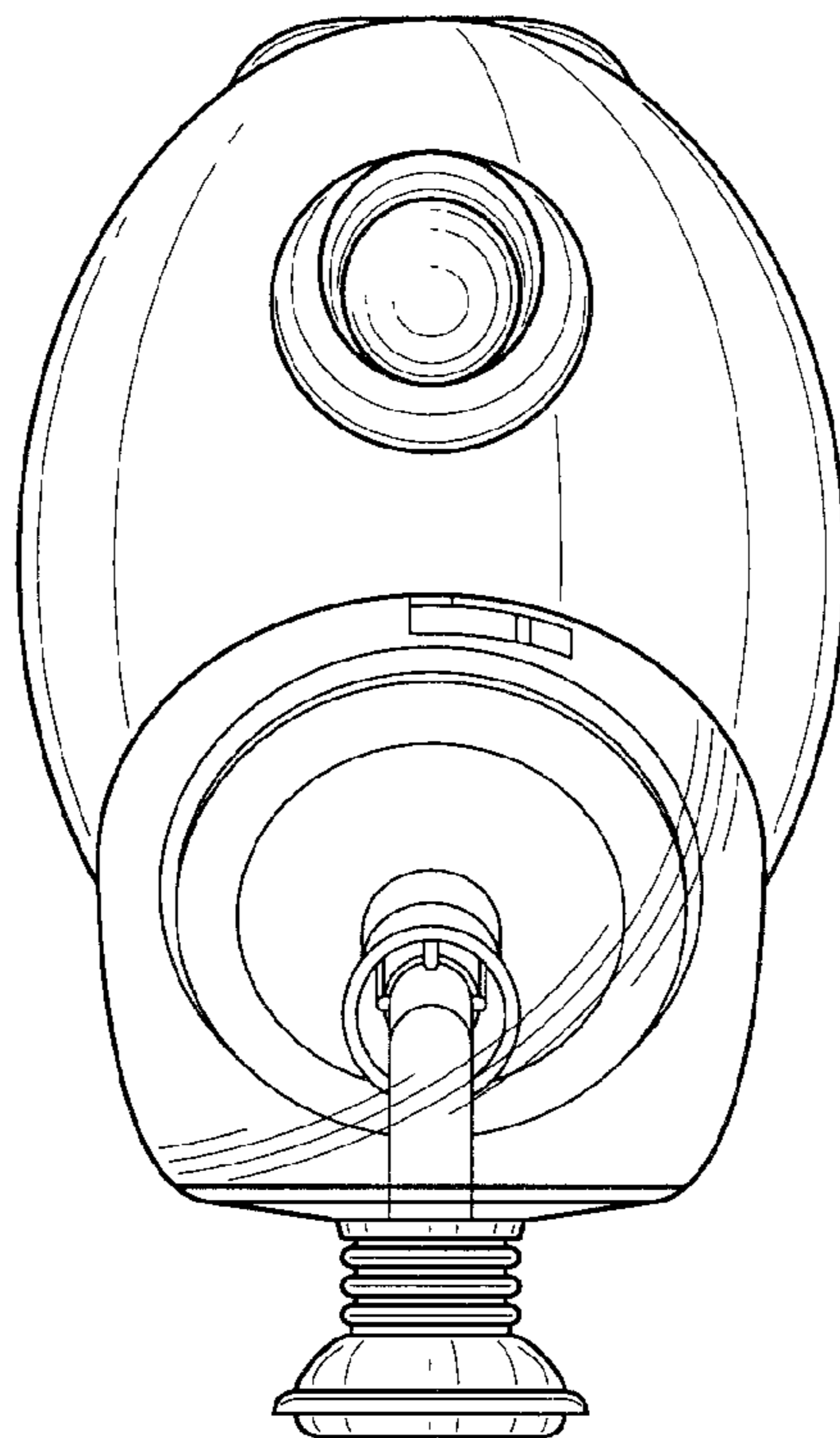

FIG. 6

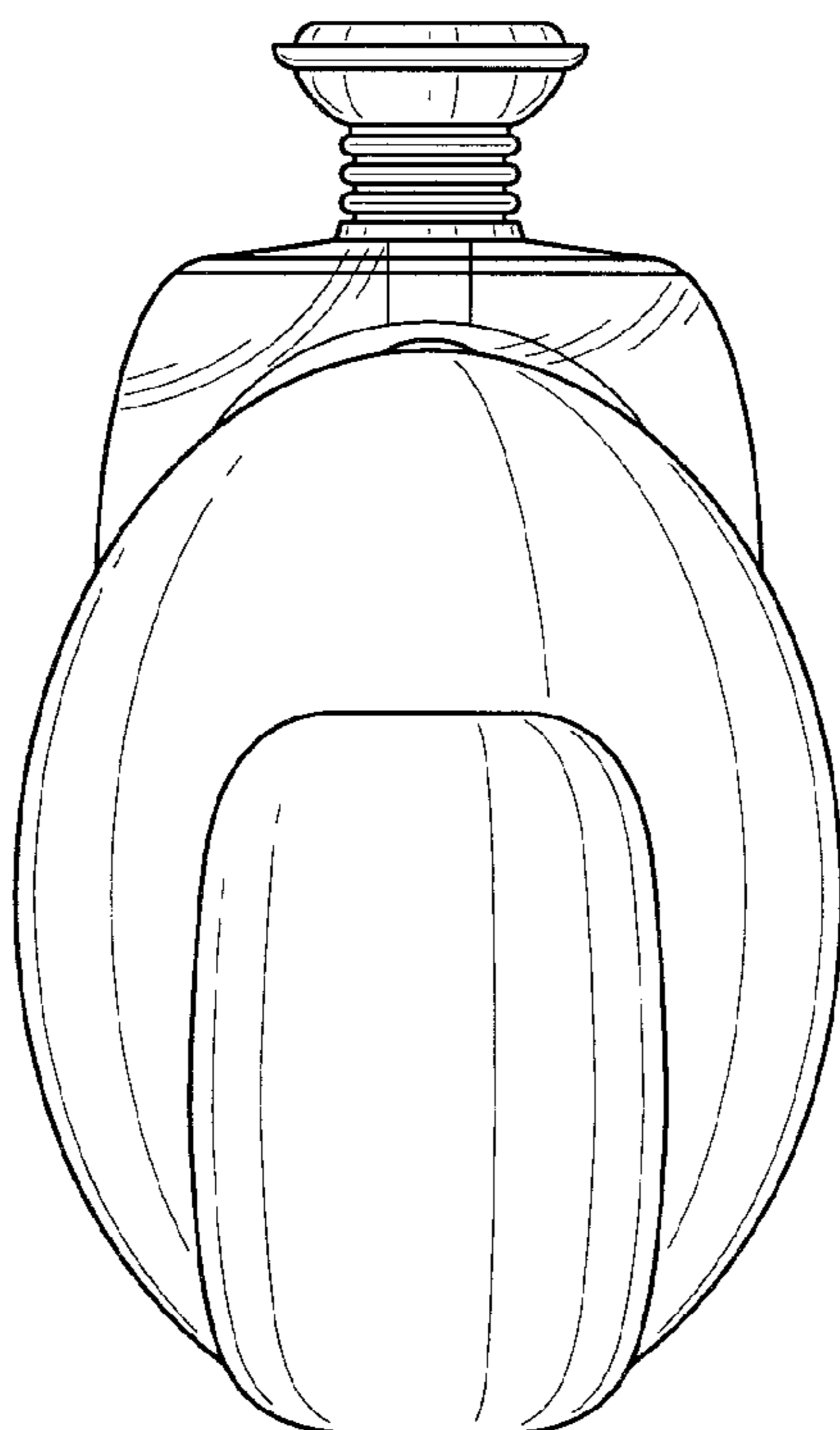

FIG. 7

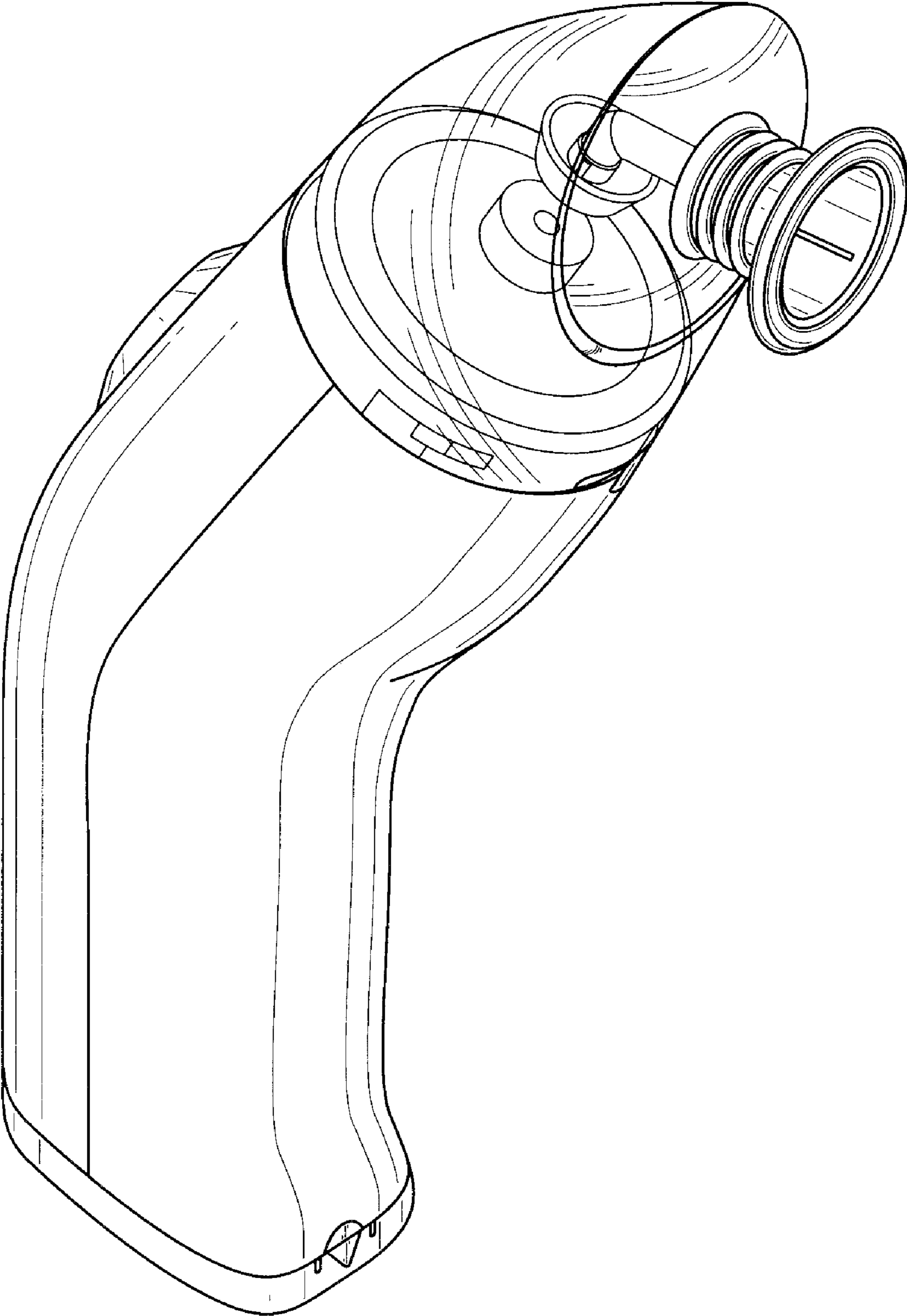

FIG. 8

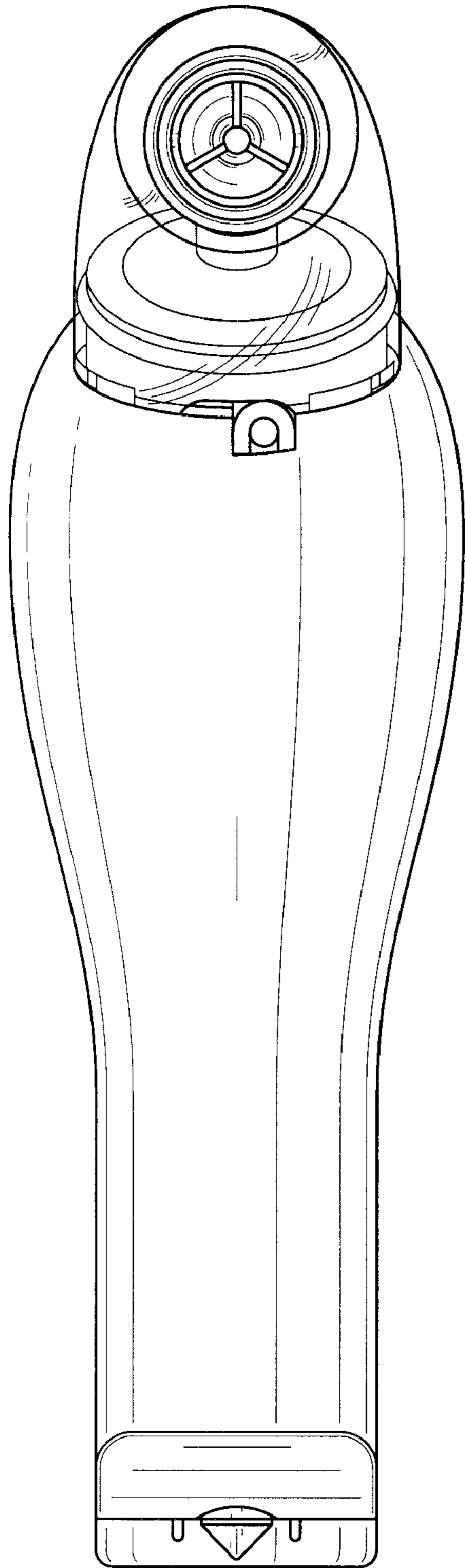

FIG. 9

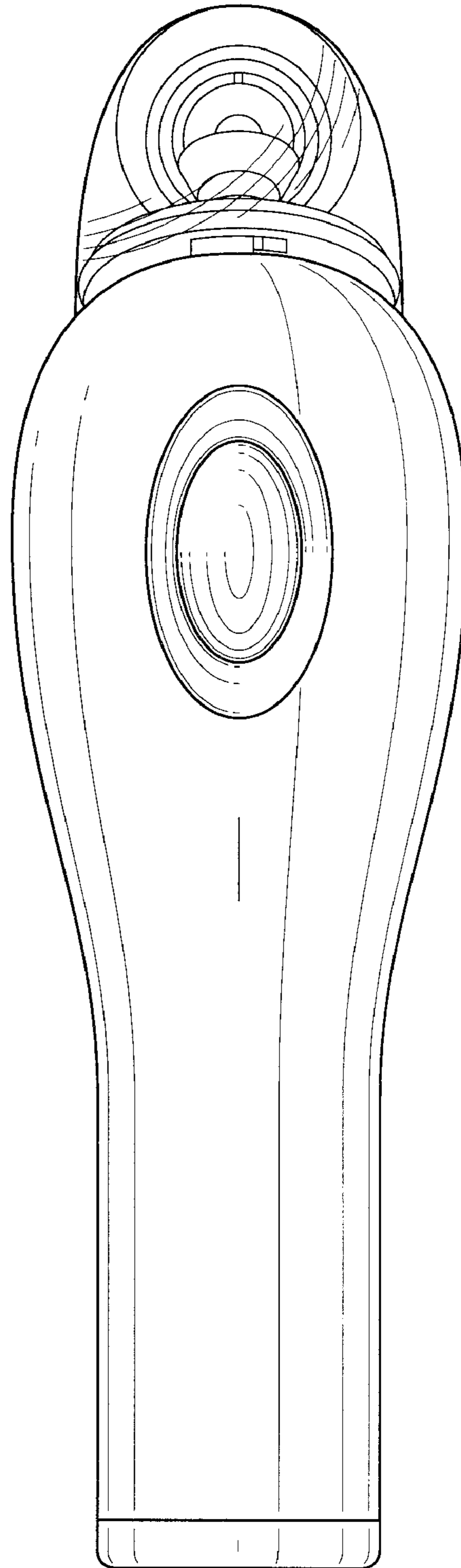

FIG. 10

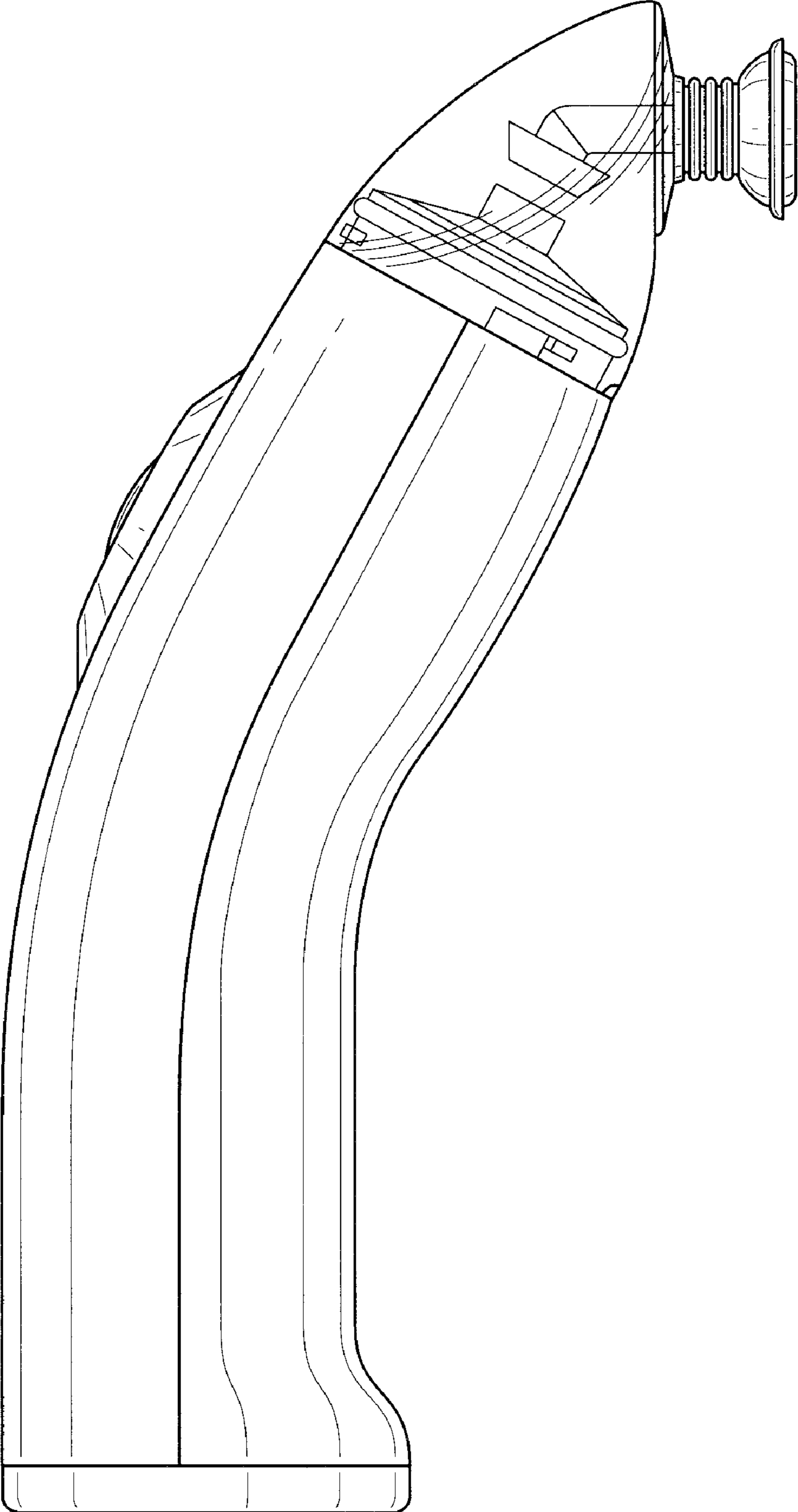

FIG. 11

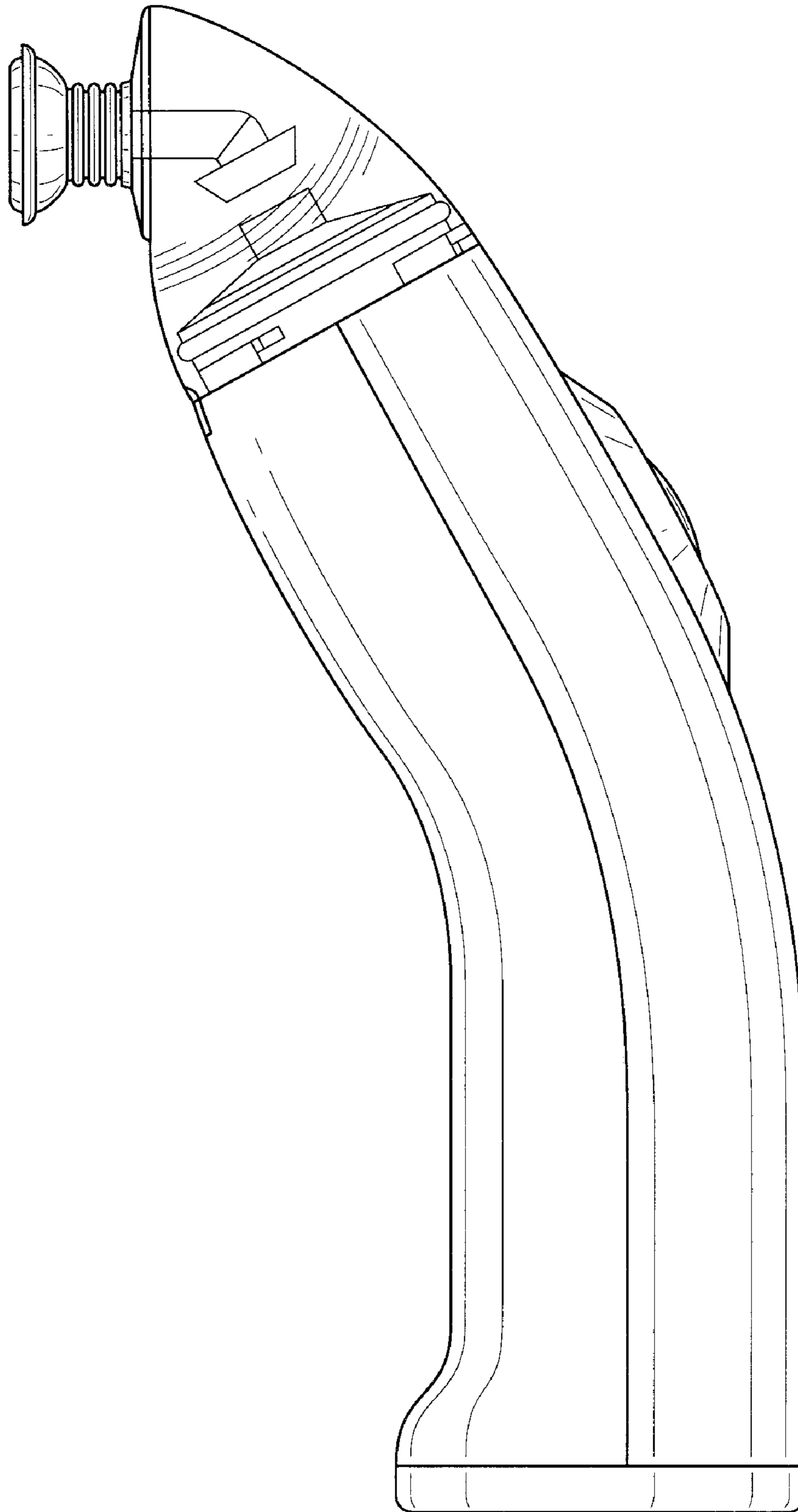

FIG. 12

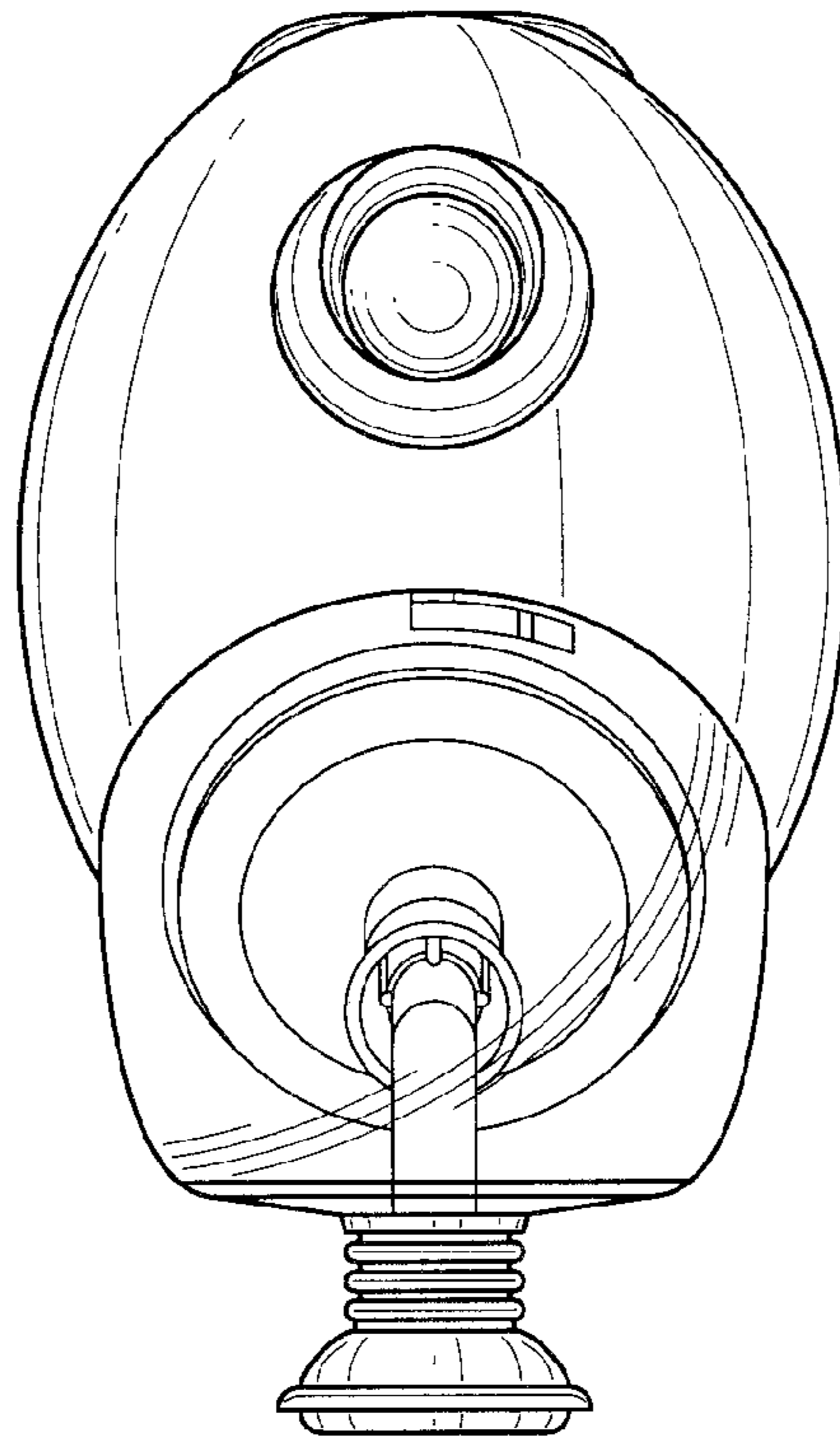

FIG. 13

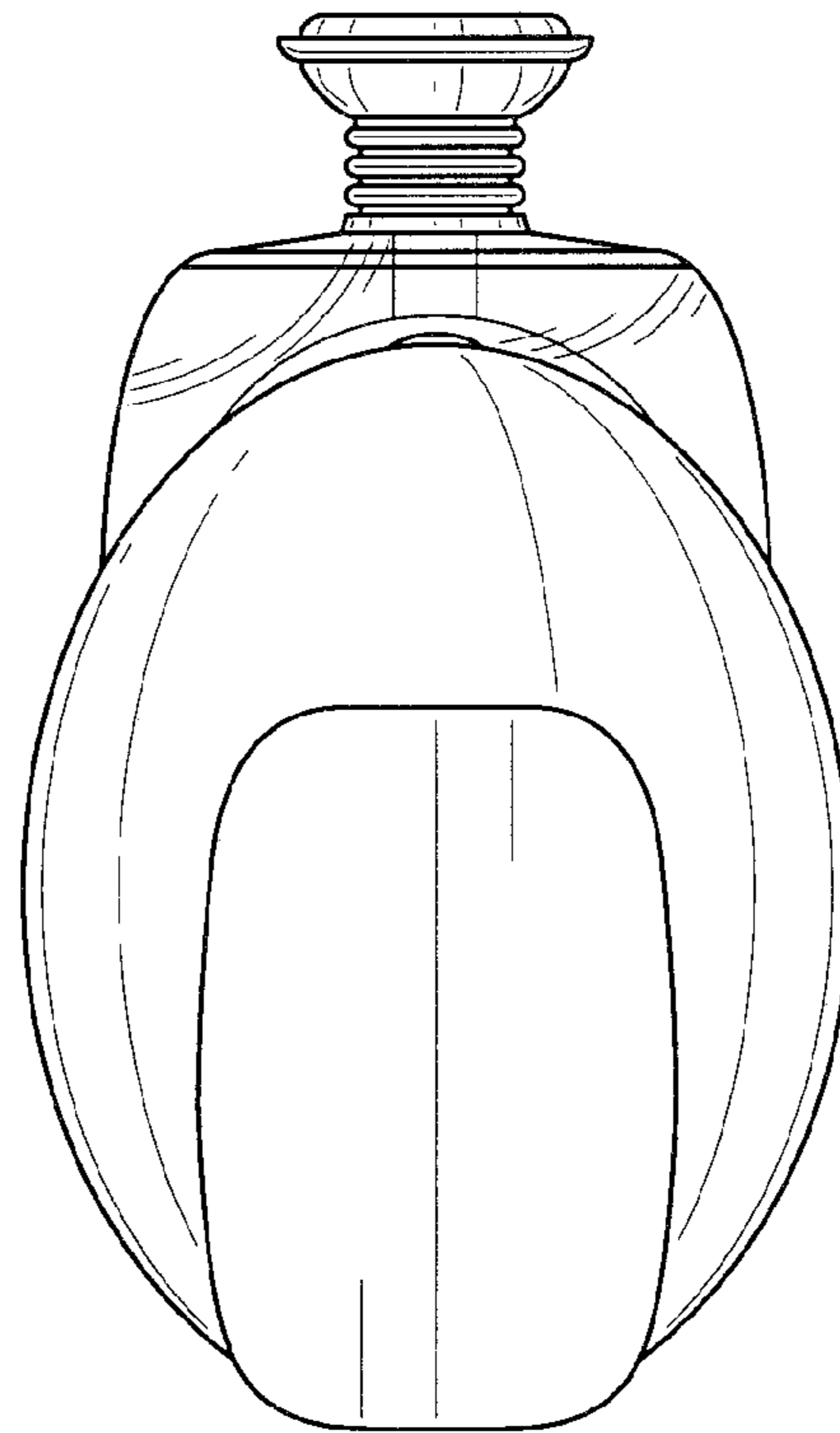

FIG. 14