



US00D558768S

(12) **United States Design Patent**
Jenkins et al.

(10) **Patent No.:** **US D558,768 S**
(45) **Date of Patent:** **** Jan. 1, 2008**

(54) **MOBILE DEVICE HANDLE**

(75) Inventors: **Ian Jenkins**, Stony Brook, NY (US);
Graham Marshall, Shoreham, NY
(US); **Robert J. Kowalski**, Commack,
NY (US); **Drew Money**, Cincinnati, OH
(US)

(73) Assignee: **Symbol Technologies, Inc.**, Holtsville,
NY (US)

(**) Term: **14 Years**

(21) Appl. No.: **29/257,221**

(22) Filed: **Mar. 30, 2006**

(51) **LOC (8) Cl.** **14-02**

(52) **U.S. Cl.** **D14/428**

(58) **Field of Classification Search** D14/420,
D14/425, 426, 428, 429, 453, 346, 34; 358/473;
235/462.43, 462.45, 462.47, 462.48, 472.01,
235/472.02; 16/422, 110.1, 430, 431
See application file for complete search history.

(56) **References Cited**

U.S. PATENT DOCUMENTS

4,694,182	A *	9/1987	Howard	250/566
5,280,159	A *	1/1994	Schultz et al.	235/382
6,095,421	A *	8/2000	Barkan et al.	235/462.22
D435,557	S *	12/2000	Eisenberg et al.	D14/428
6,158,662	A *	12/2000	Kahn et al.	235/472.01
6,244,513	B1 *	6/2001	Schlieffers et al.	235/472.01

D460,075	S *	7/2002	Destefano et al.	D14/428
D476,007	S *	6/2003	Crawford et al.	D14/412
6,824,061	B1 *	11/2004	Hattersley et al.	235/472.01
7,195,168	B2 *	3/2007	Wulff	235/462.45
2003/0234291	A1 *	12/2003	Wulff et al.	235/462.48
2004/0084534	A1 *	5/2004	Bhatia et al.	235/472.01
2005/0017078	A1 *	1/2005	Bhatia et al.	235/462.45

* cited by examiner

Primary Examiner—M. H. Tung

Assistant Examiner—Susan Moon Lee

(74) *Attorney, Agent, or Firm*—Fay Kaplun & Marcin, LLP

(57) **CLAIM**

The ornamental design for a mobile device handle, as shown and described.

DESCRIPTION

FIG. 1 is a front view of a mobile device handle showing our new design;

FIG. 2 is a rear view thereof;

FIG. 3 is a top plan view thereof;

FIG. 4 is a bottom view thereof;

FIG. 5 is a first side view thereof; and,

FIG. 6 is a second side view thereof.

The broken lines shown in FIGS. 1–6 are included for illustrative purposes only and form no part of the claimed design.

1 Claim, 6 Drawing Sheets

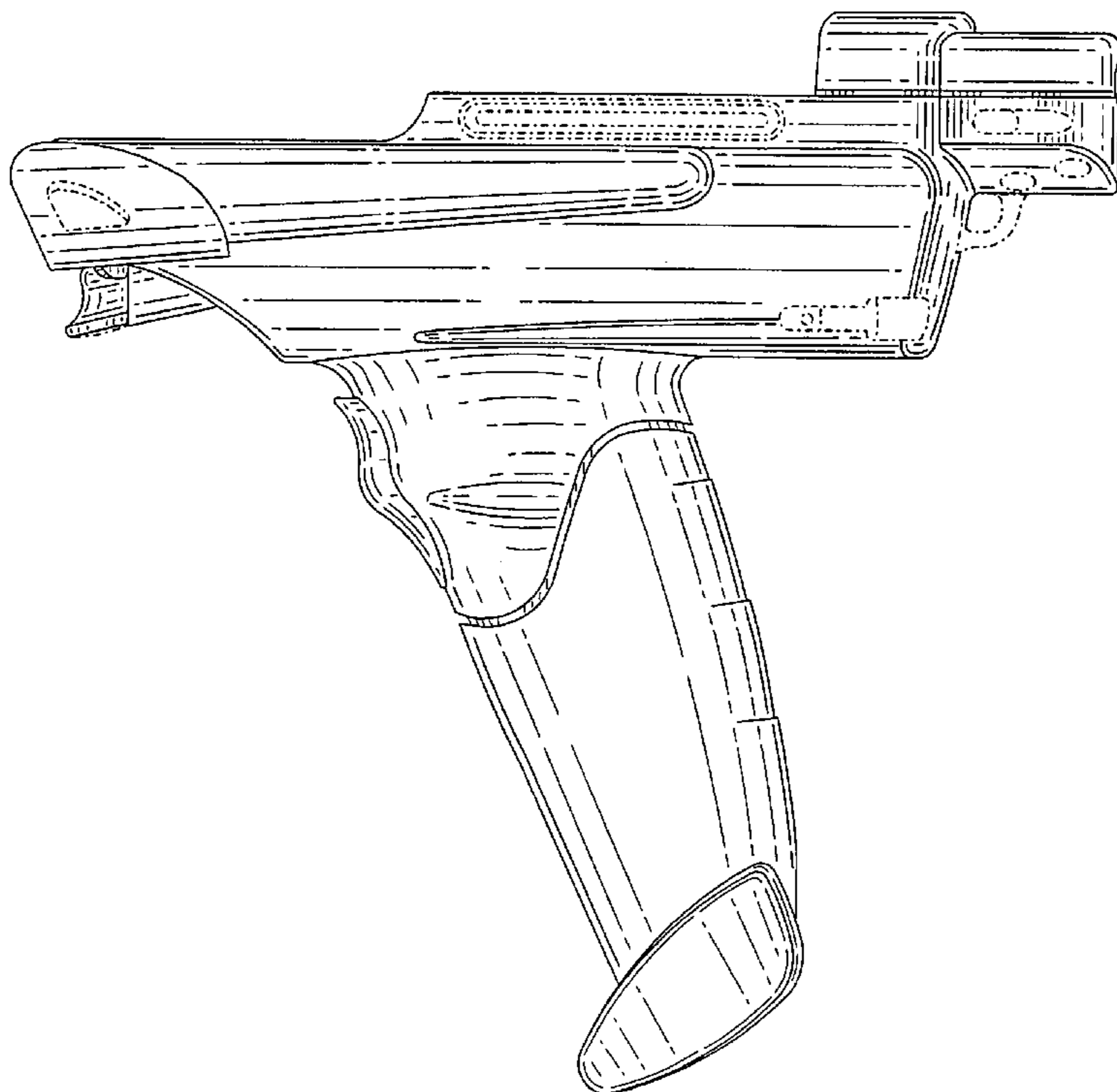

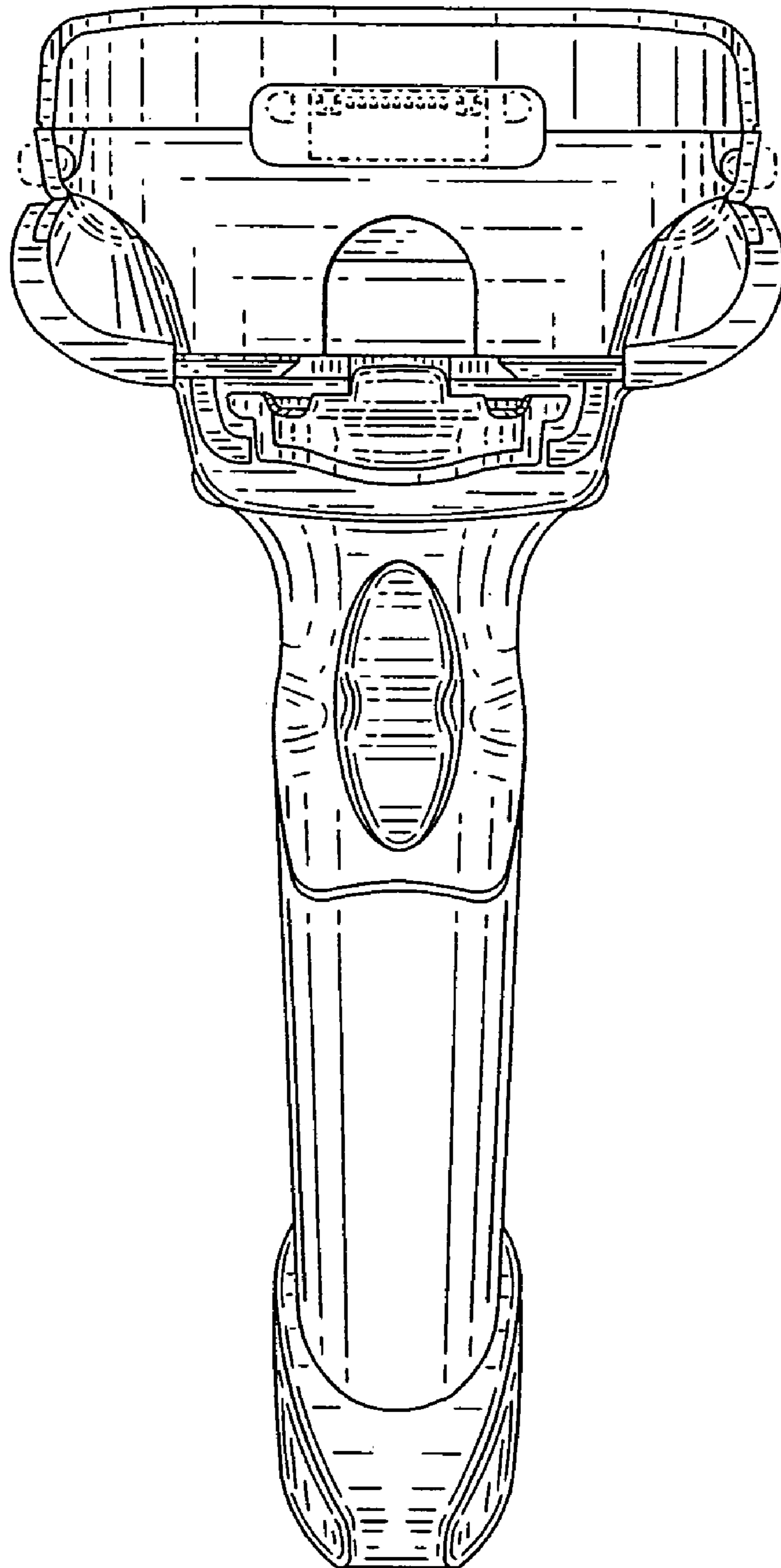

FIG. 1

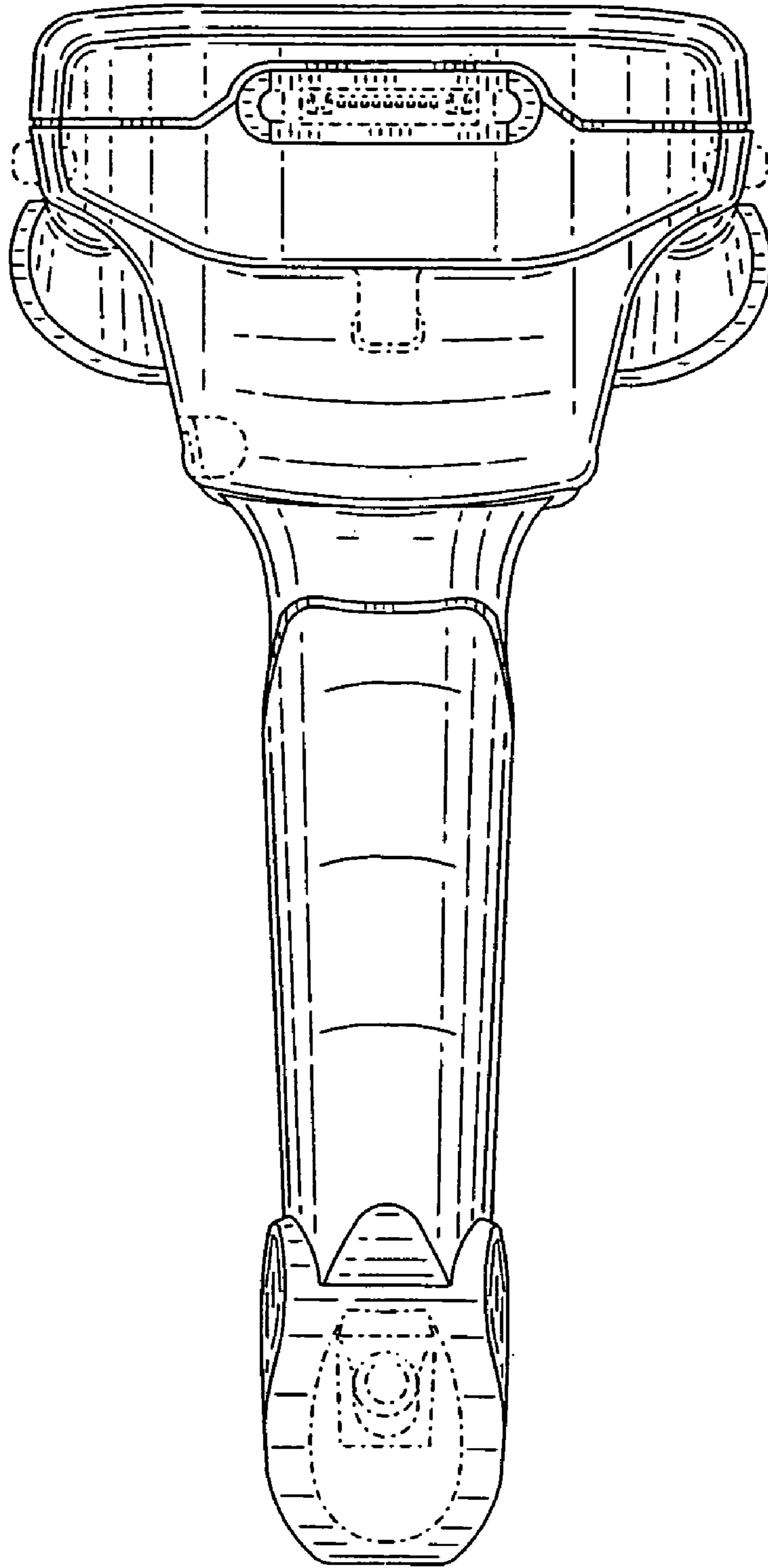

FIG. 2

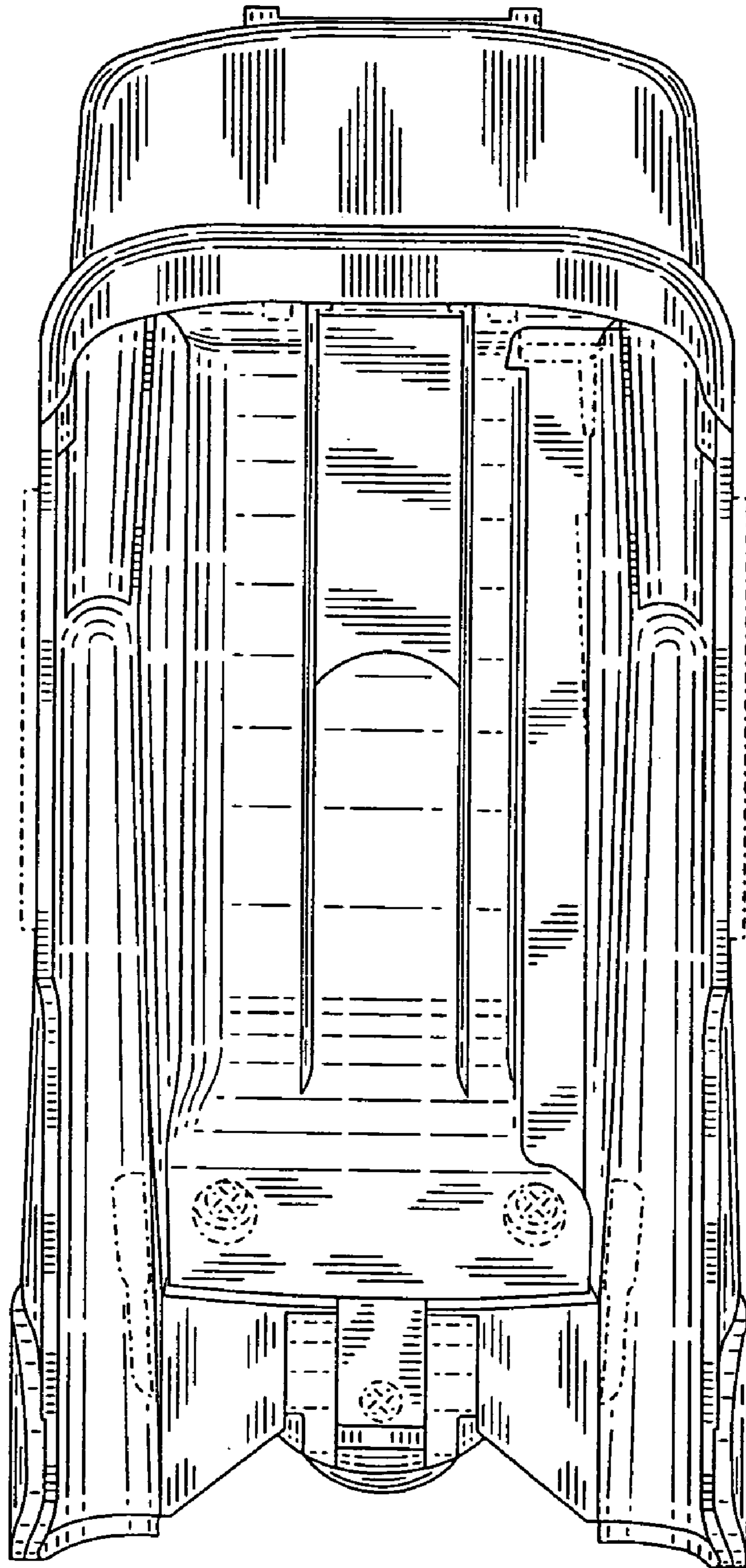

FIG. 3

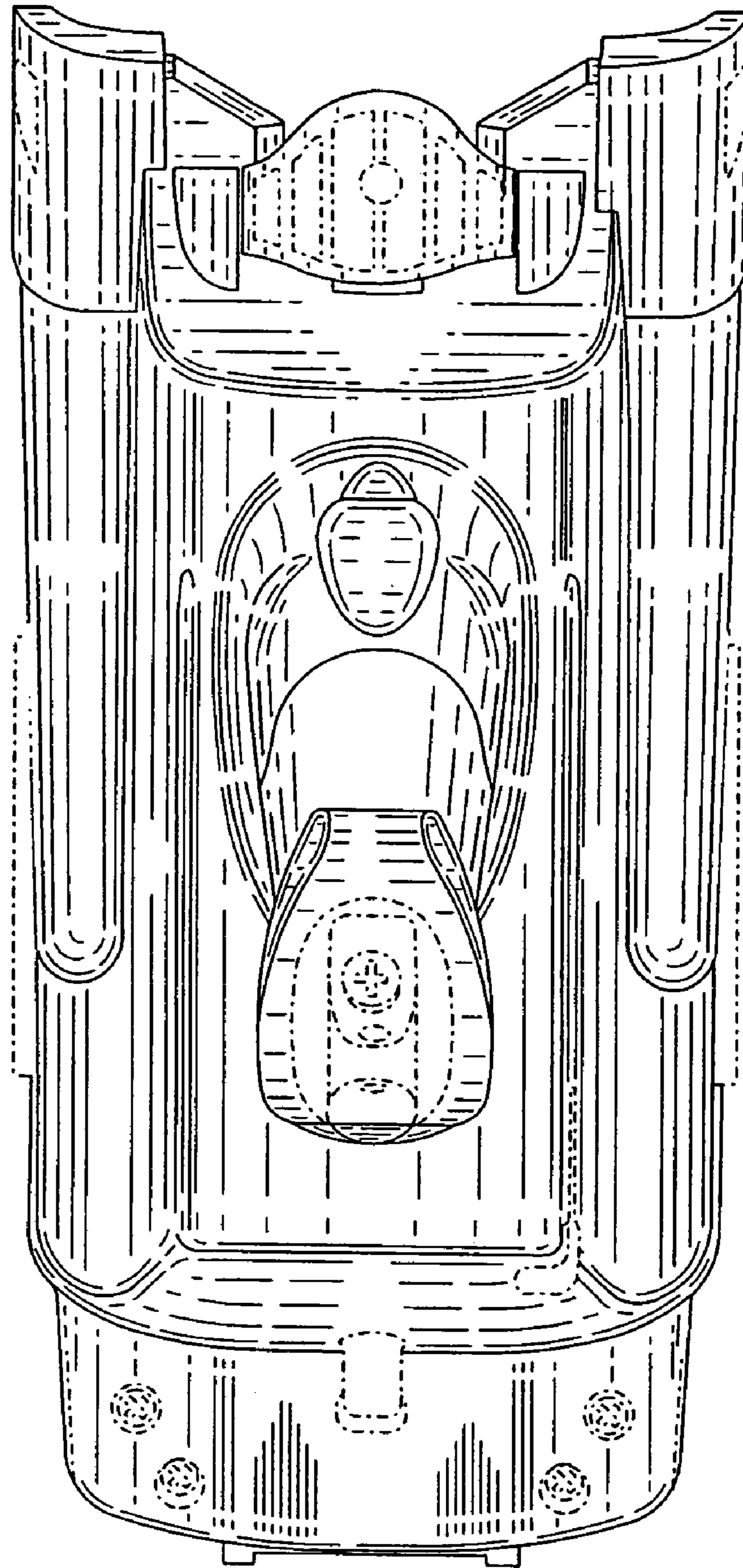

FIG. 4

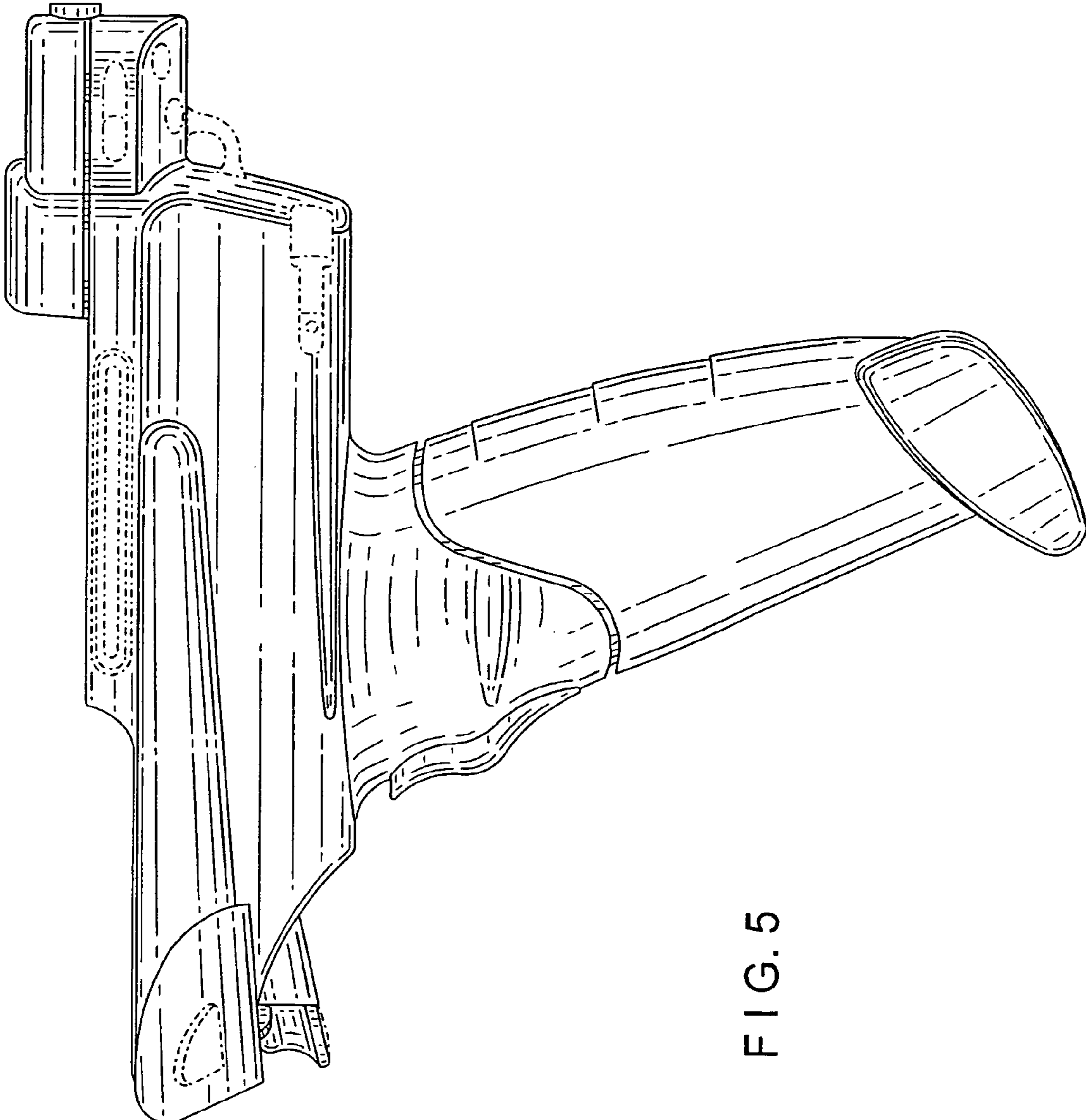

FIG. 5

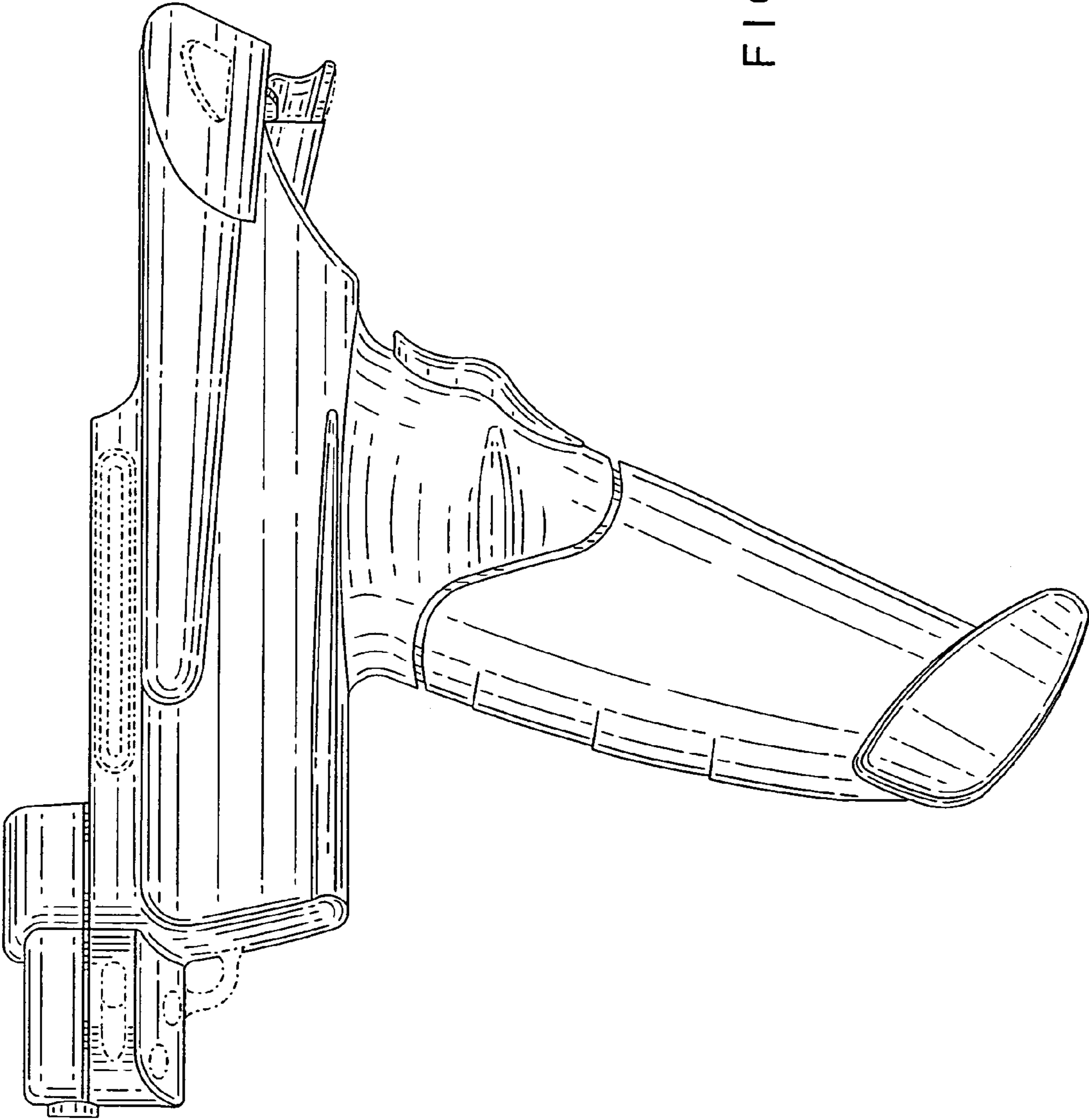

FIG. 6