



US00D558747S

(12) **United States Design Patent**  
**Salmi**

(10) **Patent No.:** **US D558,747 S**  
(45) **Date of Patent:** **\*\* Jan. 1, 2008**

(54) **FRONT COVER FOR A MULTIMEDIA DEVICE**

D533,529 S \* 12/2006 Lee et al. .... D14/138  
2005/0113155 A1\* 5/2005 Kim et al. .... 455/575.4

(75) Inventor: **Pertti Salmi**, Oulu (FI)

OTHER PUBLICATIONS

(73) Assignee: **Nokia Corporation**, Espoo (FI)

“Motorola A1000”, 2 pp including photos, [online], <URL:http://www.gsmarena.com/motorola\_a1000-pictures-653.php>, announced 1Q 2004, retrieved May 4, 2007.\*

(\*\*) Term: **14 Years**

“Nokia 7700”, 2 pp including photos, [online], <URL:http://www.gsmarena.com/nokia\_7700-570.php>, announced 4Q 2003, retrieved May 7, 2007.\*

(21) Appl. No.: **29/226,088**

“Nokia 7710”, 2 pp including photos, [online], <URL:http://www.gsmarena.com/nokia\_7710-921.php>, announced 4Q 2004, retrieved May 7, 2007.\*

(22) Filed: **Mar. 24, 2005**

\* cited by examiner

(30) **Foreign Application Priority Data**

Oct. 29, 2004 (FI) ..... M20040171

*Primary Examiner*—Ian Simmons

(51) **LOC (8) Cl.** ..... **14-03**

*Assistant Examiner*—Carla Jobe Wright

(52) **U.S. Cl.** ..... **D14/248**

(74) *Attorney, Agent, or Firm*—Banner & Witcoff, Ltd.

(58) **Field of Classification Search** ..... D14/137–138,  
D14/147–148, 156, 218, 247–248, 341–347,  
D14/496; D16/208; D21/329, 331, 333,  
D21/517; 348/14.01–14.02; 361/814; 379/  
433.01–433.13; 455/556.1–556.2, 575.1,  
455/575.3, 575.4, 566, 90.3

(57) **CLAIM**

See application file for complete search history.

The ornamental design for a front cover for a multimedia device, as shown and described.

**DESCRIPTION**

(56) **References Cited**

U.S. PATENT DOCUMENTS

D452,280 S \* 12/2001 Ota et al. .... D21/329  
D453,149 S \* 1/2002 Skoger et al. .... D14/138  
D494,151 S \* 8/2004 Walliser et al. .... D14/138  
D499,389 S \* 12/2004 Leith et al. .... D14/138  
D499,423 S \* 12/2004 Bahroocha et al. .... D14/496  
D502,945 S \* 3/2005 Huang et al. .... D14/341  
D506,753 S \* 6/2005 Duarte et al. .... D14/346  
D507,003 S \* 7/2005 Pai et al. .... D14/496  
D511,528 S \* 11/2005 Yang ..... D14/496  
D528,090 S \* 9/2006 Lee et al. .... D14/138  
D530,699 S \* 10/2006 Lee et al. .... D14/138

FIG. 1 is a top plan view of a front cover for a multimedia device showing my new design;

FIG. 2 is a right side view thereof;

FIG. 3 is a front view thereof;

FIG. 4 is a left side view thereof;

FIG. 5 is a bottom plan view thereof; and,

FIG. 6 is a perspective front view thereof.

The broken line showing of the environment and unshaded regions is for illustrative purposes only and forms no part of the claimed design.

**1 Claim, 3 Drawing Sheets**

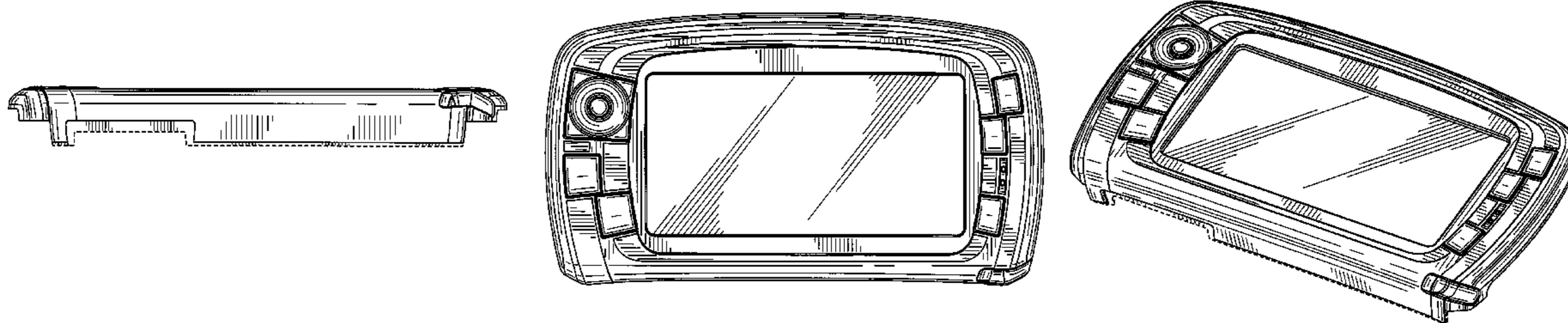

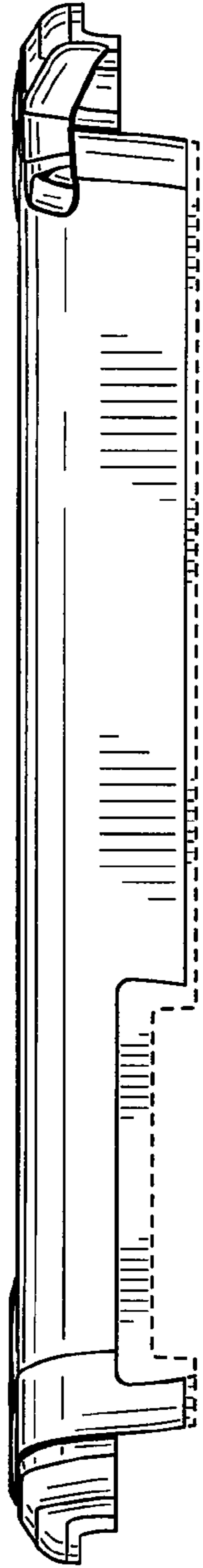

FIG. 1

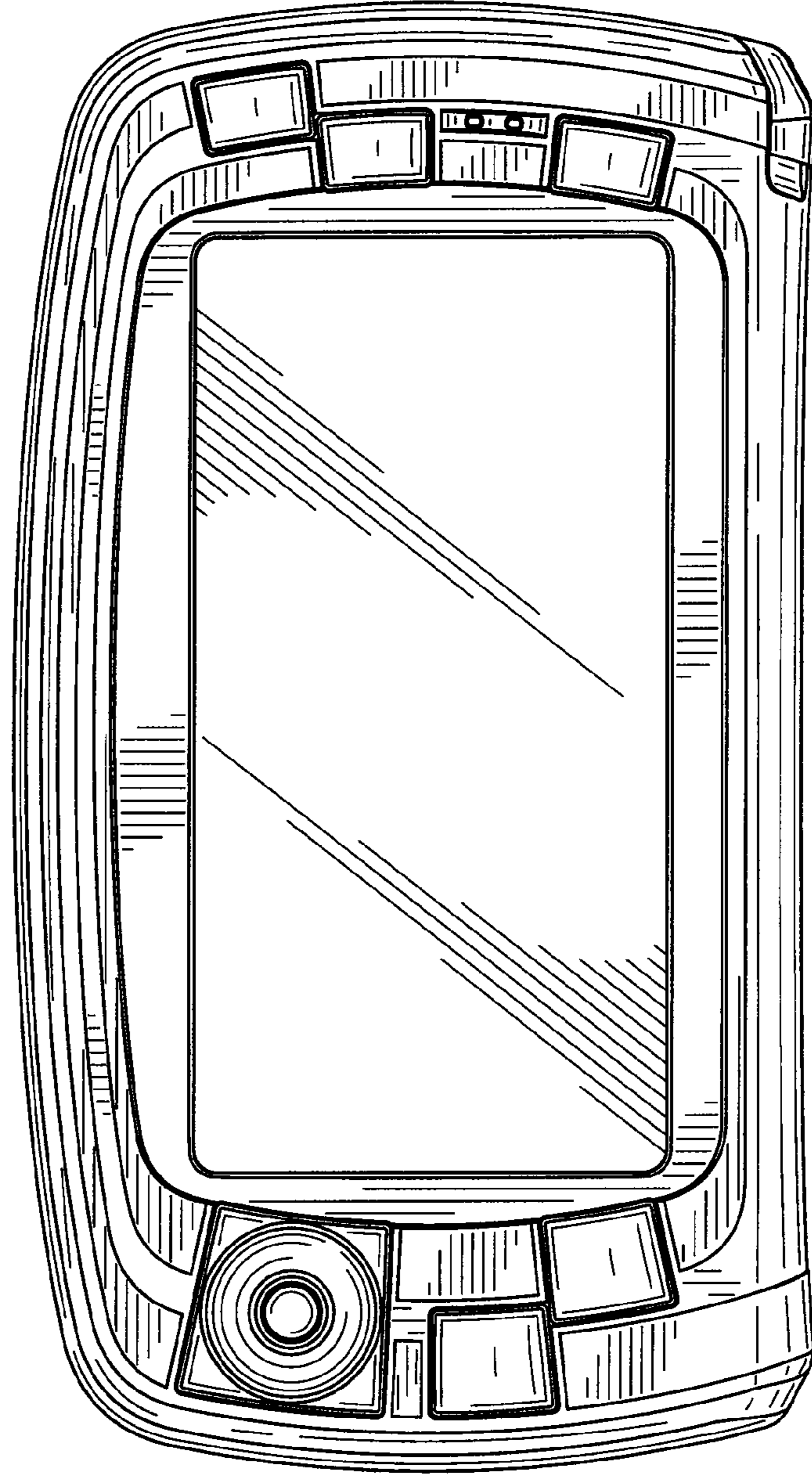

FIG. 2

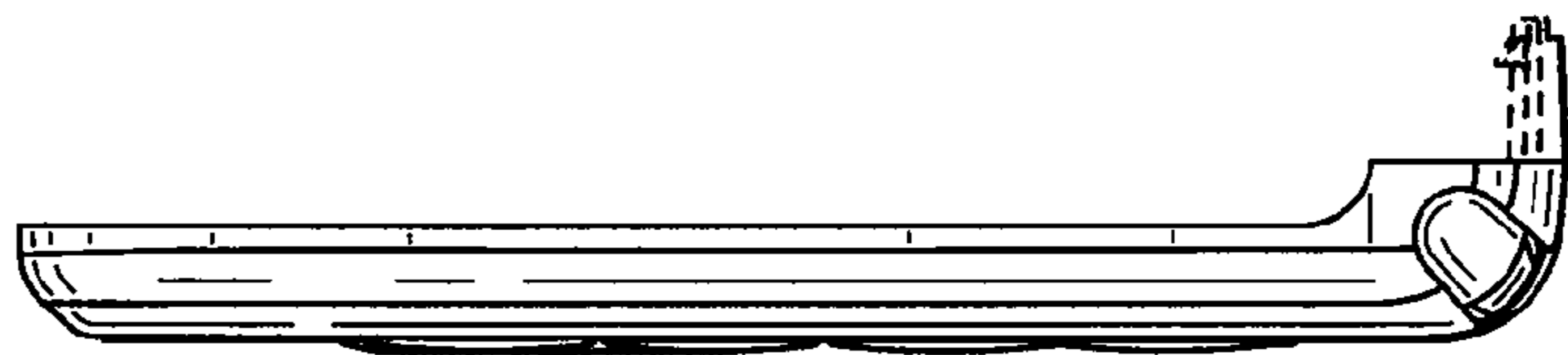

FIG. 3

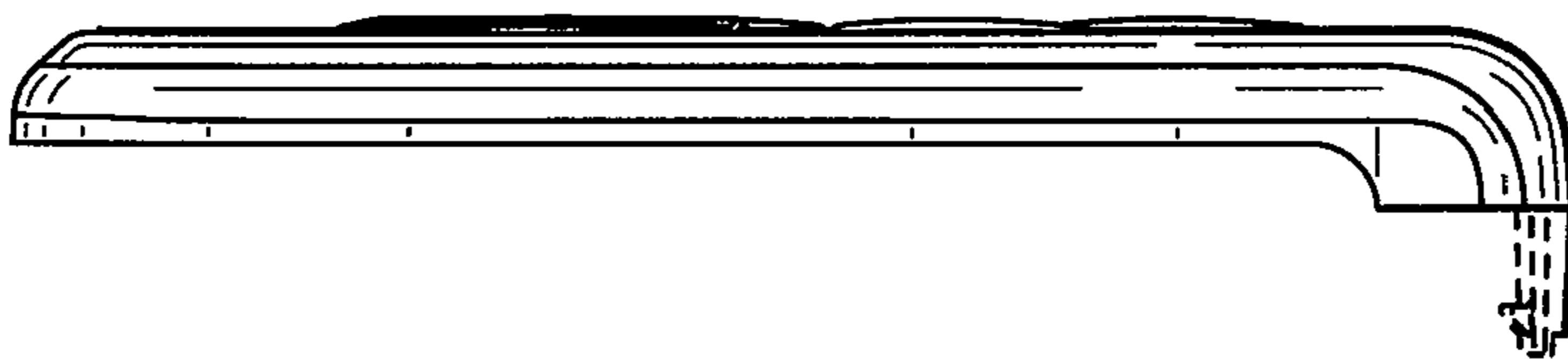

FIG. 4

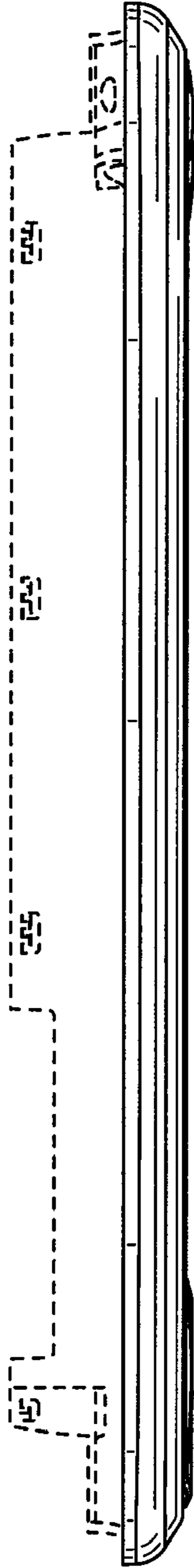

FIG. 5

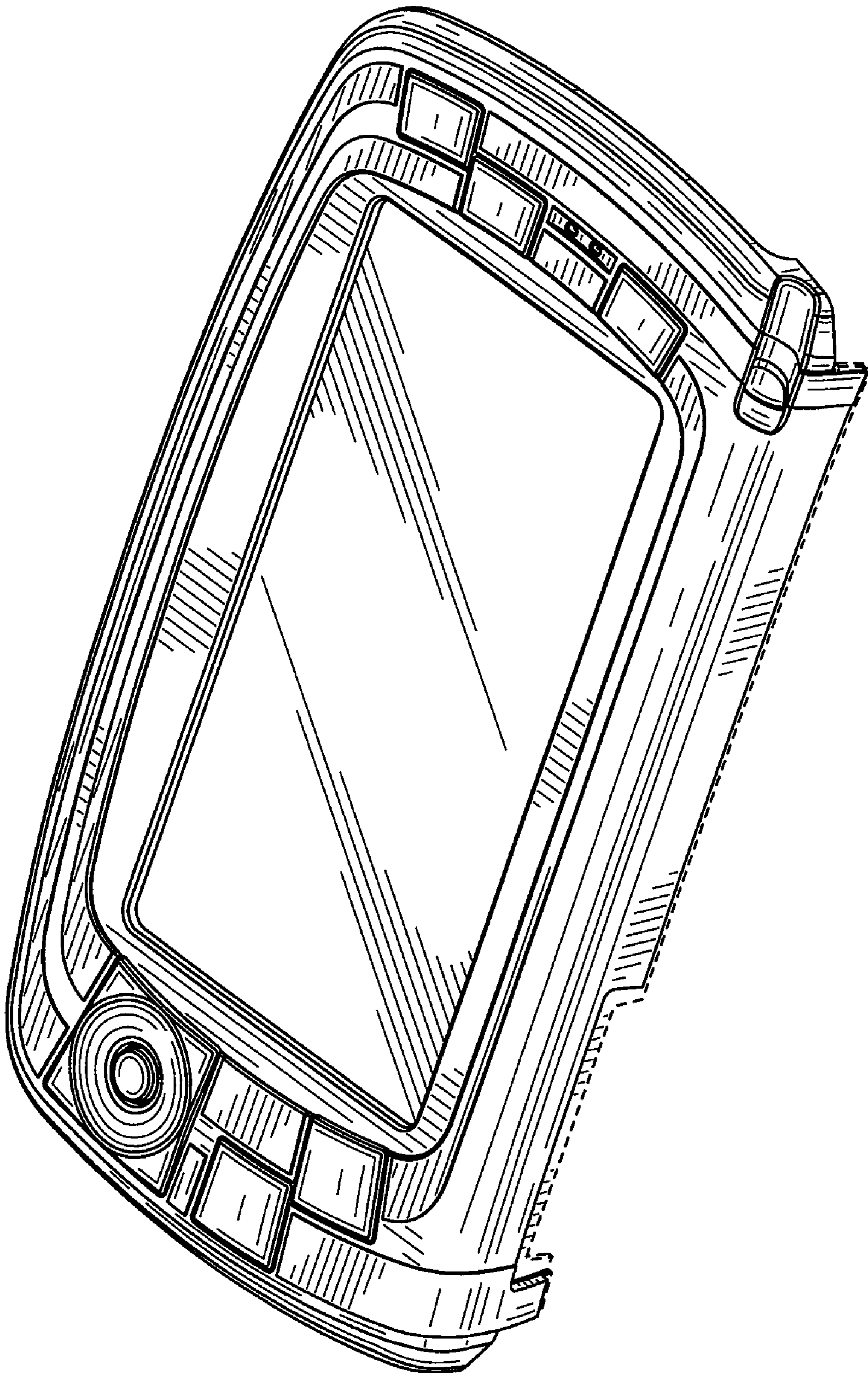

FIG. 6