



US00D558712S

(12) **United States Design Patent**  
**Kim et al.**

(10) **Patent No.:** **US D558,712 S**  
(45) **Date of Patent:** **\*\* Jan. 1, 2008**

(54) **MOBILE PHONE**

(75) Inventors: **Dong-Kyu Kim**, Namyangju-si (KR);  
**Beom-Ku Han**, Seoul (KR);  
**Chang-Soo Lee**, Incheon (KR)

(73) Assignee: **Samsung Electronics Co., Ltd.**,  
Suwon-Si (KR)

(\*\*) Term: **14 Years**

(21) Appl. No.: **29/263,624**

(22) Filed: **Jul. 27, 2006**

(30) **Foreign Application Priority Data**

May 25, 2006 (KR) ..... 30-2006-0019322

(51) **LOC (8) Cl.** ..... **14-03**

(52) **U.S. Cl.** ..... **D14/138**

(58) **Field of Classification Search** ..... D14/496,  
D14/138, 341-347; 455/575.3, 575.1; D21/517,  
D21/329, 333

See application file for complete search history.

(56) **References Cited**

**U.S. PATENT DOCUMENTS**

|                   |         |                 |       |         |
|-------------------|---------|-----------------|-------|---------|
| D440,955 S *      | 4/2001  | Tanaka et al.   | ..... | D14/138 |
| D468,736 S *      | 1/2003  | Loh et al.      | ..... | D14/345 |
| D476,968 S *      | 7/2003  | Yokoyama        | ..... | D14/138 |
| D488,454 S *      | 4/2004  | Lee             | ..... | D14/138 |
| D492,656 S *      | 7/2004  | Lee             | ..... | D14/138 |
| D493,440 S *      | 7/2004  | Chou et al.     | ..... | D14/138 |
| D498,468 S *      | 11/2004 | Seo             | ..... | D14/138 |
| D499,390 S *      | 12/2004 | Cho             | ..... | D14/138 |
| D507,255 S *      | 7/2005  | Watanabe et al. | ..... | D14/138 |
| D509,815 S *      | 9/2005  | Jang            | ..... | D14/138 |
| 7,089,040 B2 *    | 8/2006  | Iwabuchi et al. | ..... | 455/566 |
| D534,908 S *      | 1/2007  | Lee             | ..... | D14/346 |
| D536,689 S *      | 2/2007  | Suzuki et al.   | ..... | D14/138 |
| D539,773 S *      | 4/2007  | Kim et al.      | ..... | D14/138 |
| 2004/0242280 A1 * | 12/2004 | Hama            | ..... | 455/566 |

|                   |         |                  |       |           |
|-------------------|---------|------------------|-------|-----------|
| 2005/0261040 A1 * | 11/2005 | Andersson et al. | ..... | 455/575.3 |
| 2005/0282595 A1 * | 12/2005 | Spence et al.    | ..... | 455/575.3 |
| 2006/0019728 A1 * | 1/2006  | Sakamoto et al.  | ..... | 455/575.3 |
| 2006/0135225 A1 * | 6/2006  | Lin et al.       | ..... | 455/575.3 |
| 2007/0026909 A1 * | 2/2007  | Jung et al.      | ..... | 455/575.3 |
| 2007/0049357 A1 * | 3/2007  | Daimon et al.    | ..... | 455/575.1 |
| 2007/0054710 A1 * | 3/2007  | Pan              | ..... | 455/575.3 |

**OTHER PUBLICATIONS**

Sagem my200C telephone, announced Feb. 2007, [online], [retrieved on Jul. 19, 2007]. Retrieved from Internet , <URL: <http://www.gsmarena.com>>.\*

NEC e636 telephone, announced Feb. 2006, [online], [retrieved on Aug. 16, 2007]. Retrieved from Internet , <URL: <http://www.gsmarena.com>>.\*

Samsung U300 telephone, announced Feb. 2007, [online], [retrieved on Aug. 15, 2007]. Retrieved from Internet , <URL: <http://www.gsmarena.com>>.\*

(Continued)

*Primary Examiner*—Jeffrey Asch

(74) *Attorney, Agent, or Firm*—Staas & Halsey LLP

(57) **CLAIM**

The ornamental design for the mobile phone, as shown and described.

**DESCRIPTION**

FIG. 1 is a perspective view of the mobile phone showing our design;

FIG. 2 is a front view thereof;

FIG. 3 is a rear view thereof;

FIG. 4 is a left side view thereof;

FIG. 5 is a right side view thereof;

FIG. 6 is a top plan view thereof;

FIG. 7 is a bottom plan view thereof; and,

FIG. 8 is a right side, open view thereof.

**1 Claim, 6 Drawing Sheets**

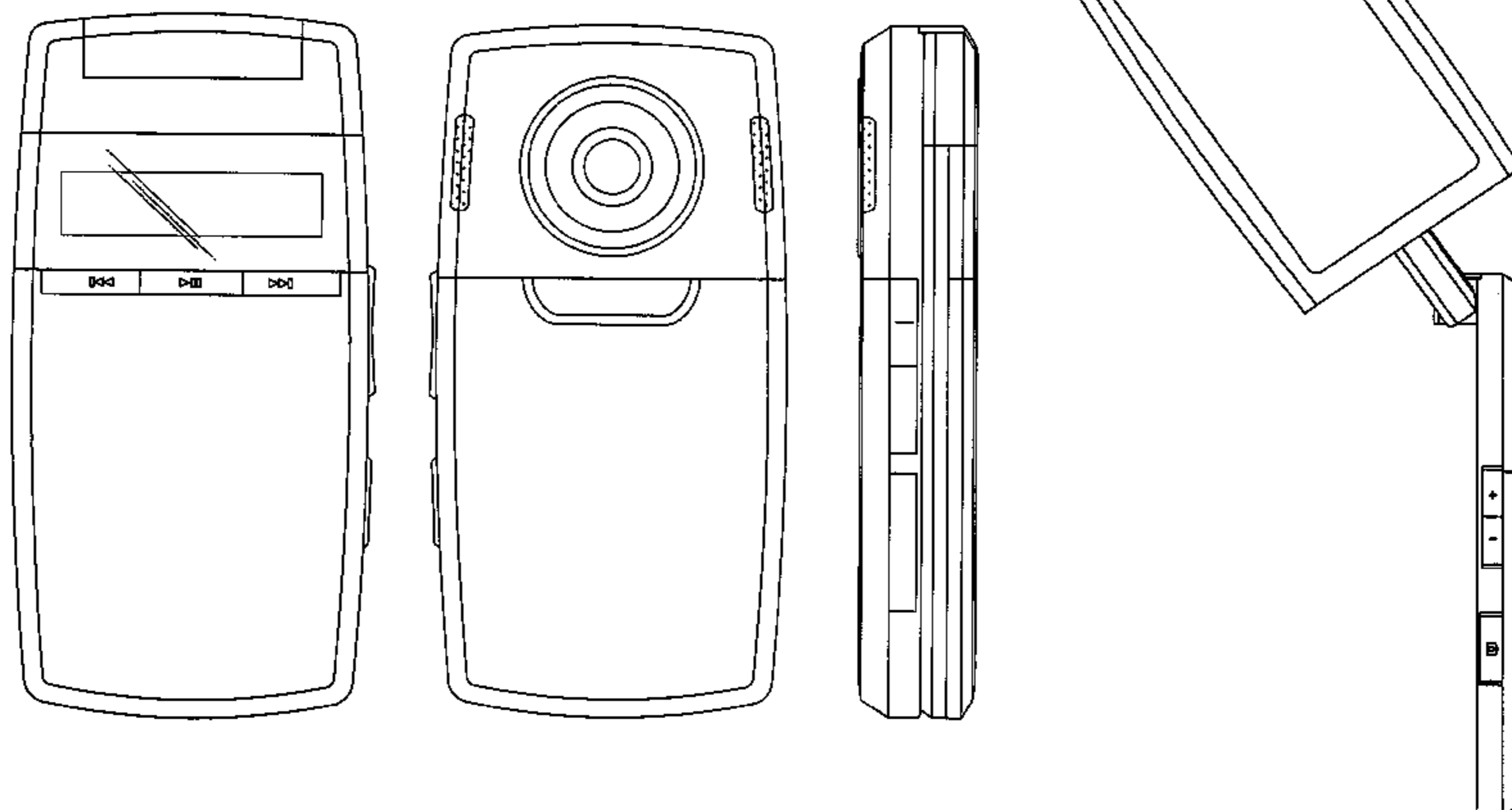

OTHER PUBLICATIONS

NEC e338 telephone, announced 3rd Quarter 2004, [online], [retrieved on Jul. 19, 2007]. Retrieved from Internet , <URL: <http://www.gsmarena.com>>.\*

Sharp 903 telephone, announced Jul. 2005, [online], [retrieved on Aug. 16, 2007]. Retrieved from Internet , <URL: <http://www.gsmarena.com>>.\*

Sony Ericsson Z600 telephone, announced 3rd Quarter 2003, [online], [retrieved on Aug. 16, 2007]. Retrieved from Internet , <URL: <http://www.gsmarena.com>>.\*

Samsung D830 telephone, announced Jun. 2006, [online], [retrieved on Aug. 15, 2007]. Retrieved from Internet , <URL: <http://www.gsmarena.com>>.\*

\* cited by examiner

FIG. 1

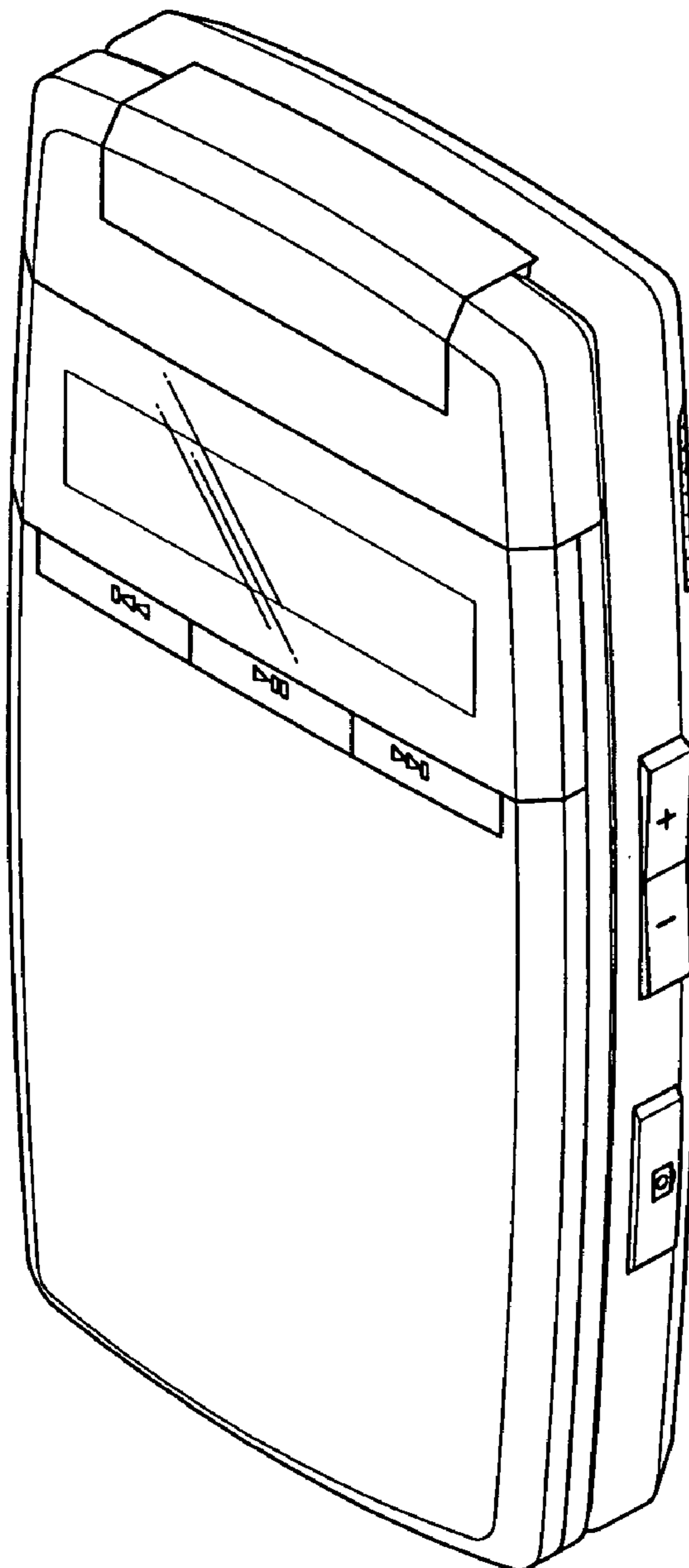

FIG. 2

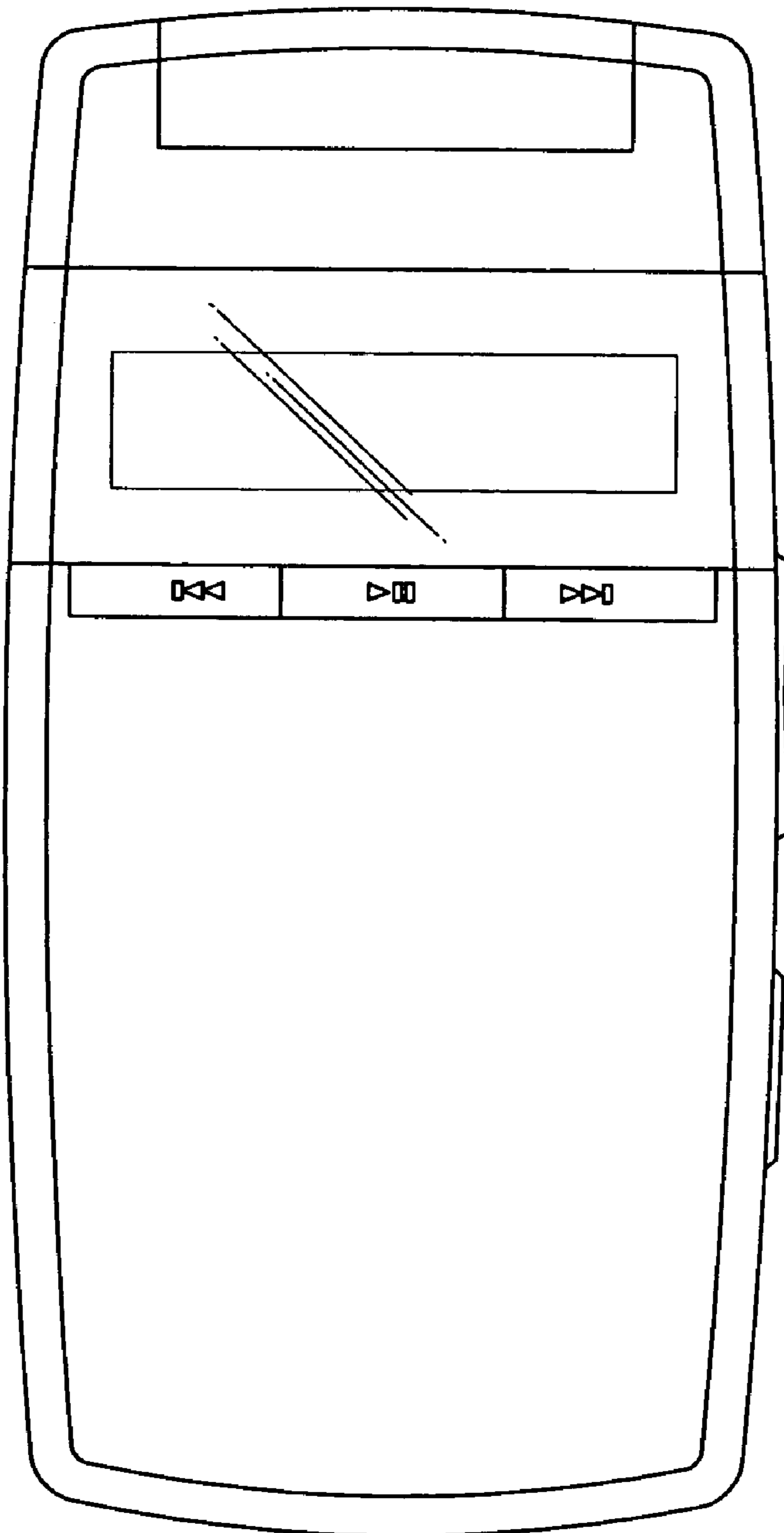

FIG. 3

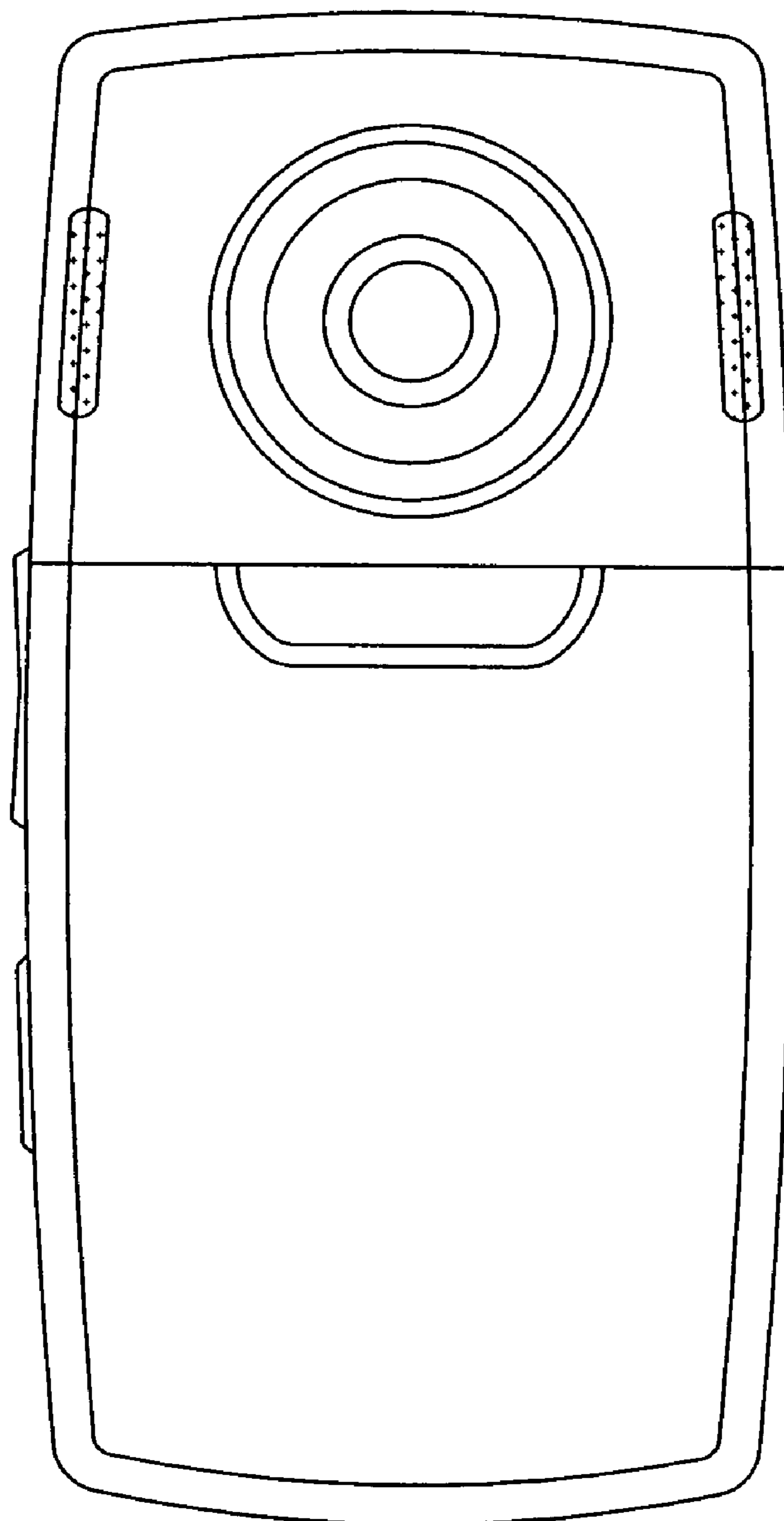

FIG. 4

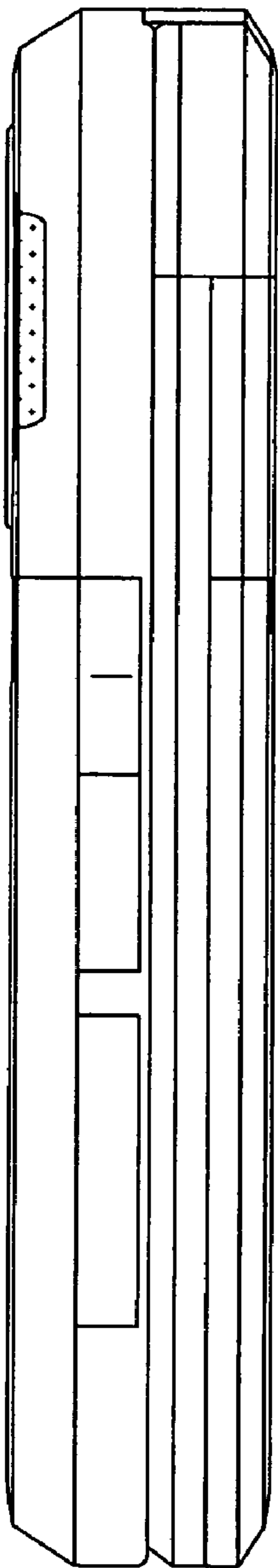

FIG. 5

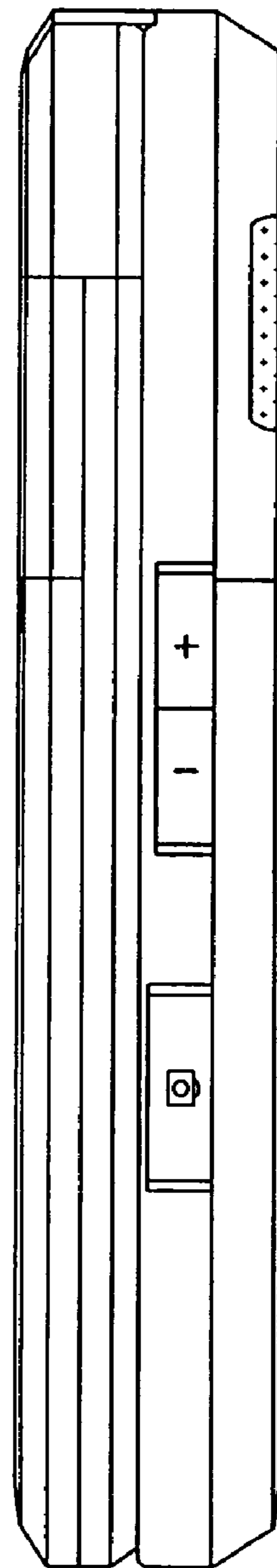

FIG. 6

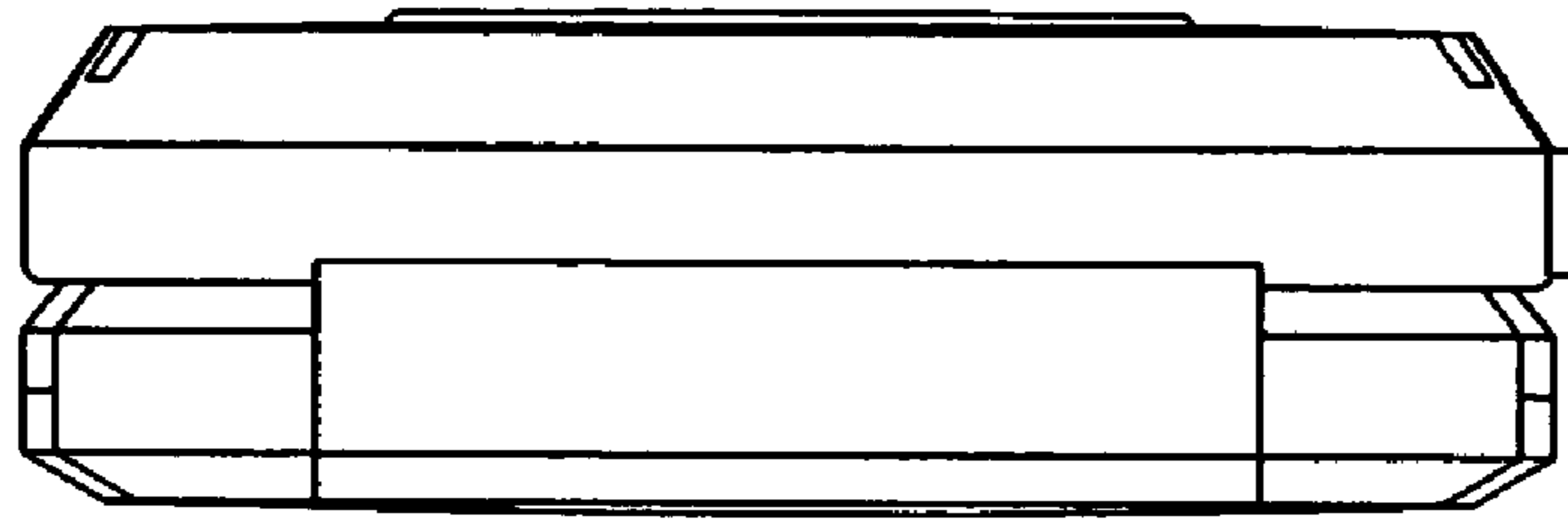

FIG. 7

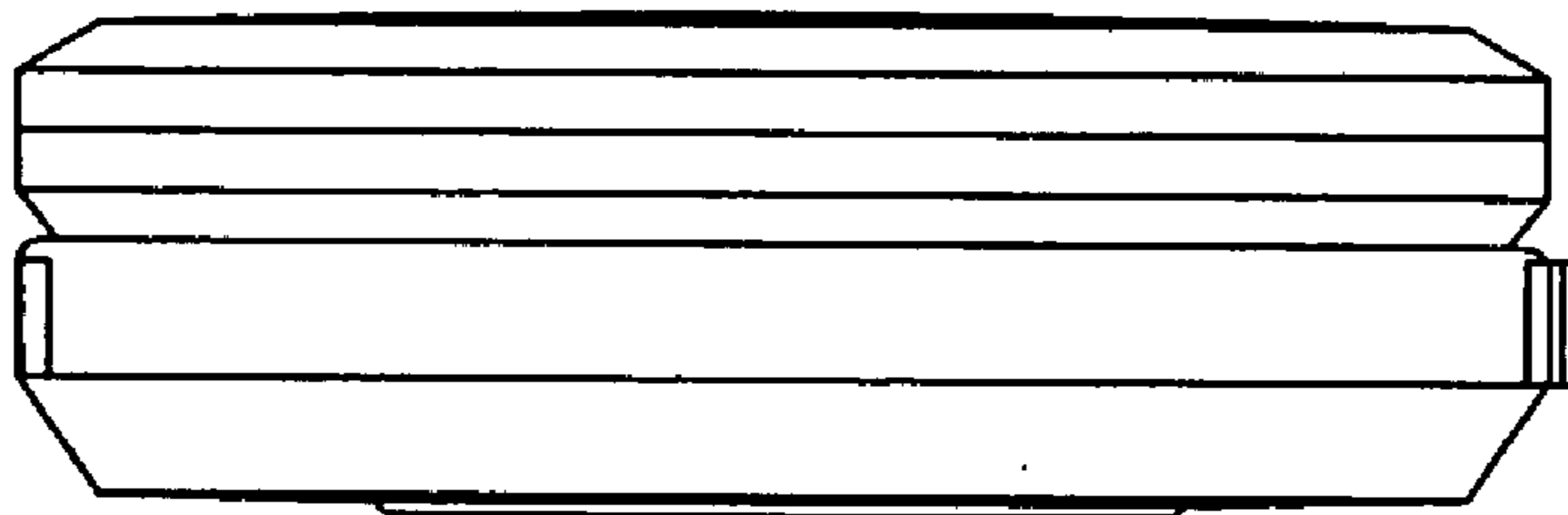

FIG. 8

