



US00D558647S

(12) **United States Design Patent**
Seckel et al.

(10) **Patent No.:** **US D558,647 S**
(45) **Date of Patent:** **** Jan. 1, 2008**

(54) **TELESCOPING BICYCLE**

(75) Inventors: **Timothy Seckel**, Streamwood, IL (US);
Earle Cramer, Chicago, IL (US);
Edward Eaton, Eola, IL (US);
Eduardo Mendoza, Jr., Charlotte, NC
(US)

(73) Assignee: **Radio Flyer, Inc.**, Chicago, IL (US)

(**) Term: **14 Years**

(21) Appl. No.: **29/266,891**

(22) Filed: **Sep. 29, 2006**

(51) **LOC (8) Cl.** **12-11**

(52) **U.S. Cl.** **D12/111**

(58) **Field of Classification Search** D12/111-113;
280/274-280, 281.1, 282-288, 288.1-288.3,
280/293, 296, 298-301, 304, 263, 265, 270,
280/271; D21/432, 435, 538

See application file for complete search history.

(56) **References Cited**

U.S. PATENT DOCUMENTS

4,730,840 A *	3/1988	Goldmeier	280/210
D369,331 S *	4/1996	Niemeyer	D12/112
D377,773 S *	2/1997	Sloss	D12/111
D513,210 S *	12/2005	Piszkin	D12/111

* cited by examiner

Primary Examiner—Cathron C. Brooks

Assistant Examiner—Linda Brooks

(74) *Attorney, Agent, or Firm*—DLA Piper US LLP; R. Blake Johnston, Esq.

(57) **CLAIM**

The ornamental design for the telescoping bicycle, as shown and described.

DESCRIPTION

FIG. 1 is a perspective view of the telescoping bicycle in a first configuration;

FIG. 2 is a front elevational view of the telescoping bicycle;

FIG. 3 is a rear elevational view of the telescoping bicycle;

FIG. 4 is a left side elevational view of the telescoping bicycle in the first configuration, the opposite side of which is an identical mirror image;

FIG. 5 is a top plan view of the telescoping bicycle in the first configuration;

FIG. 6 is a bottom plan view of the telescoping bicycle in the first configuration; and,

FIG. 7 is a perspective view of the telescoping bicycle in a second configuration.

1 Claim, 7 Drawing Sheets

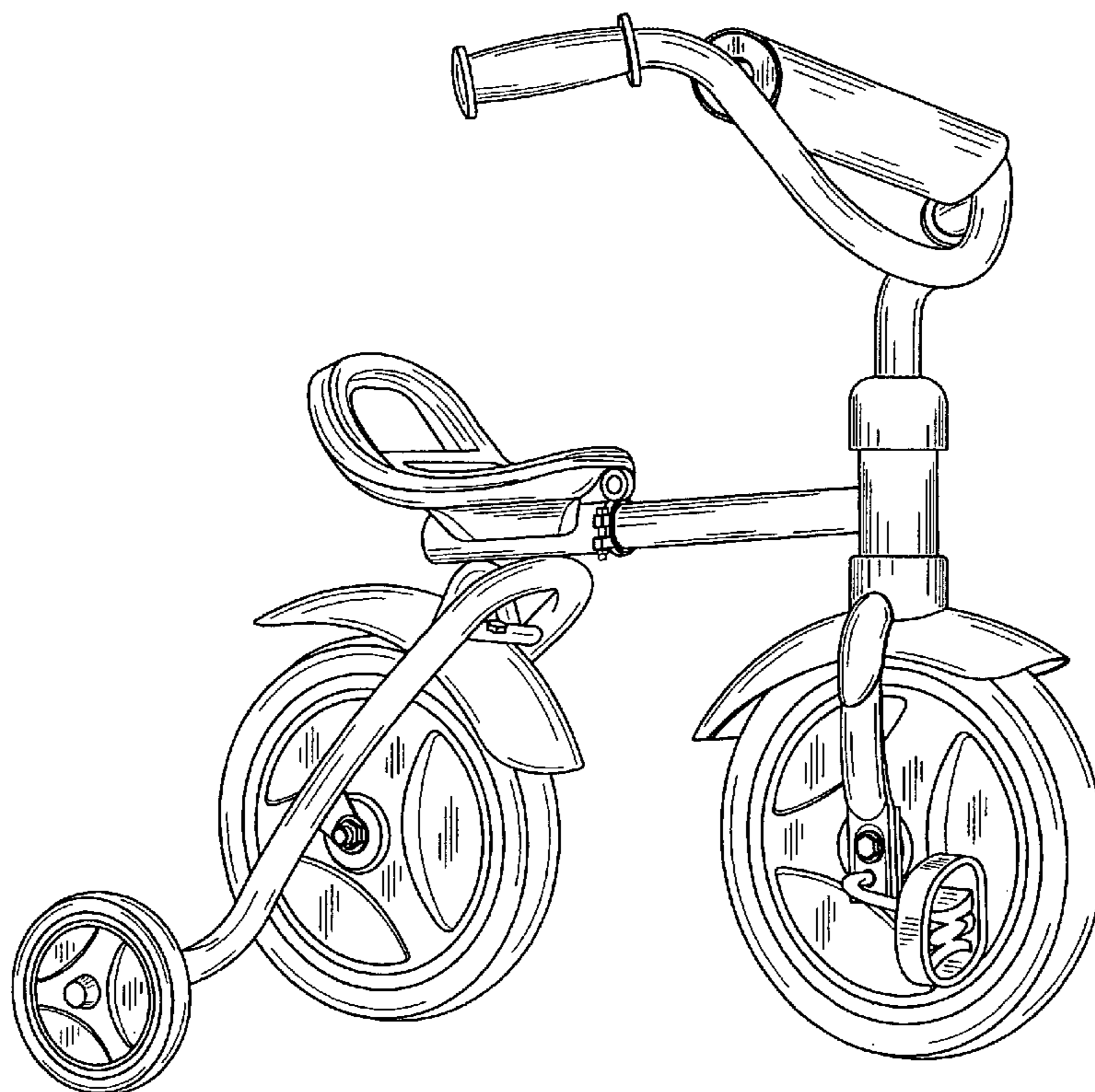

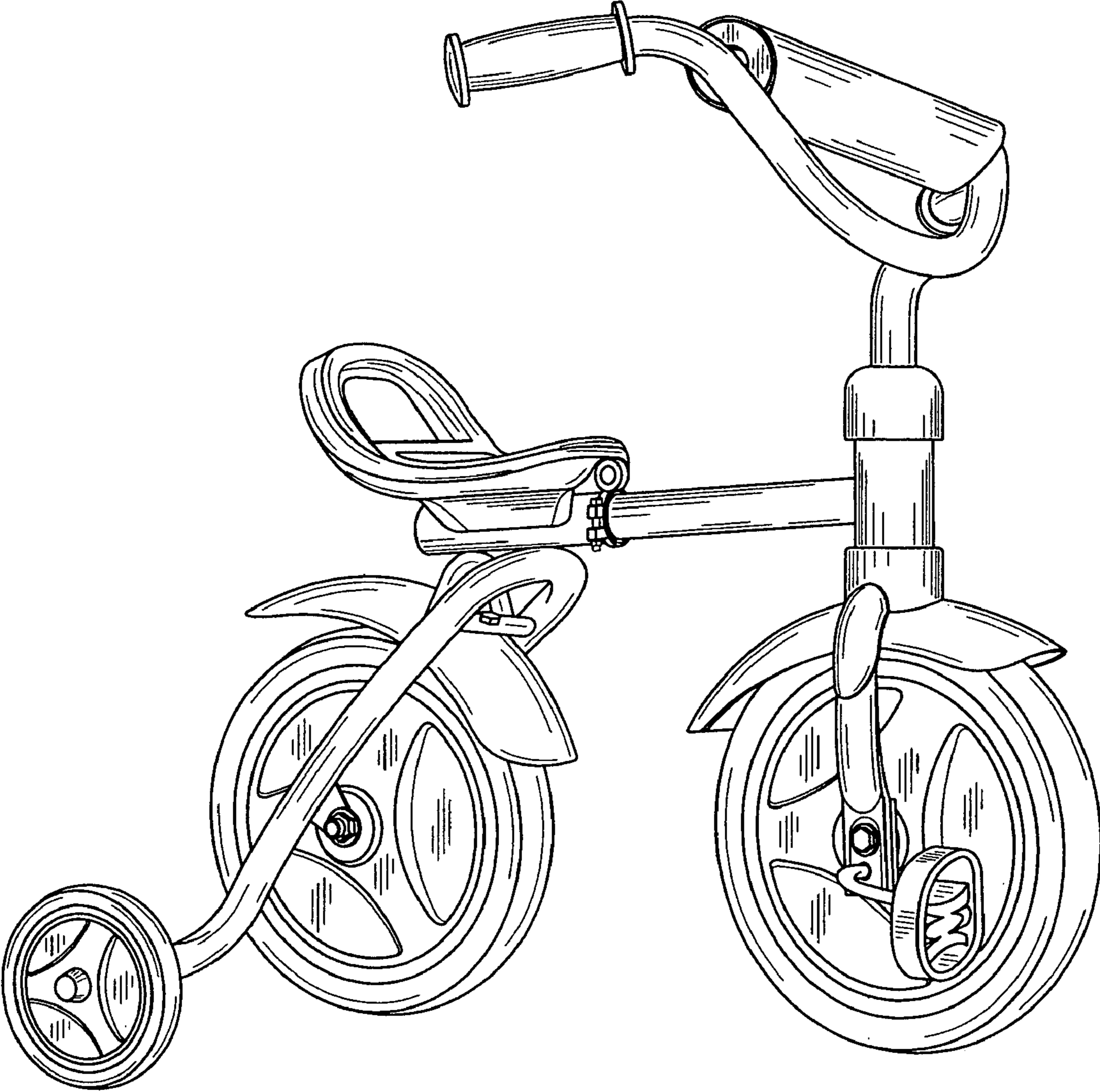

FIG. 1

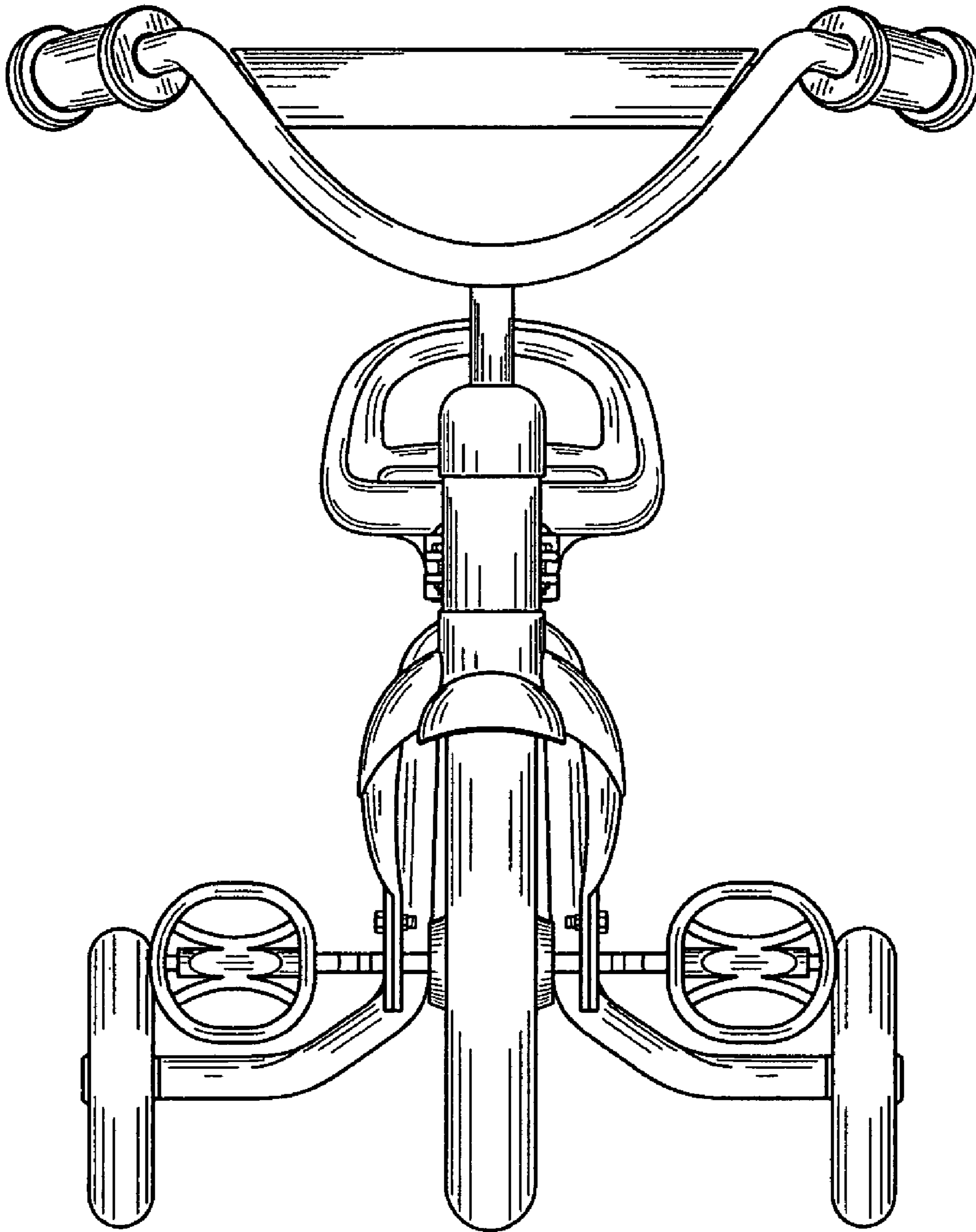

FIG. 2

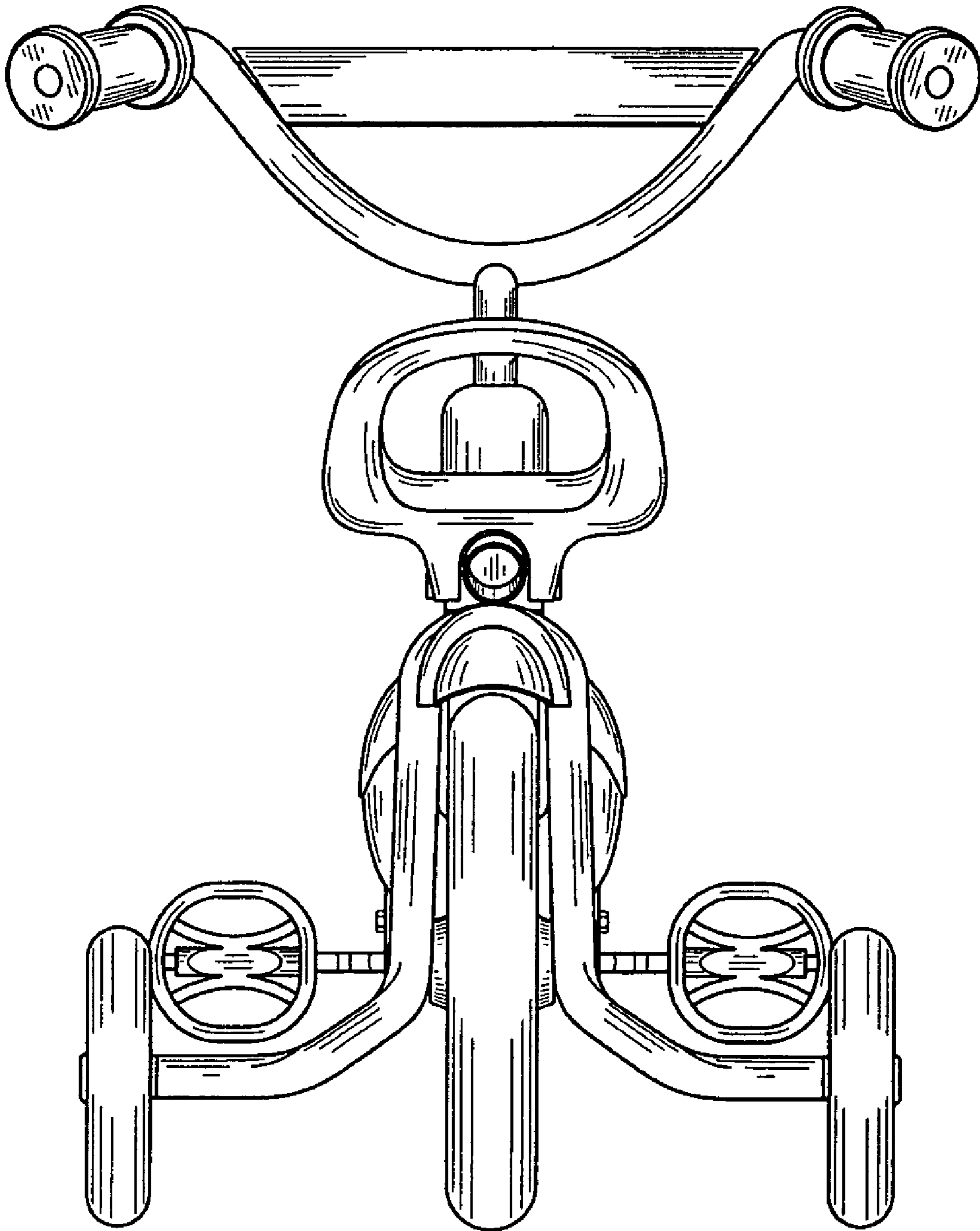

FIG. 3

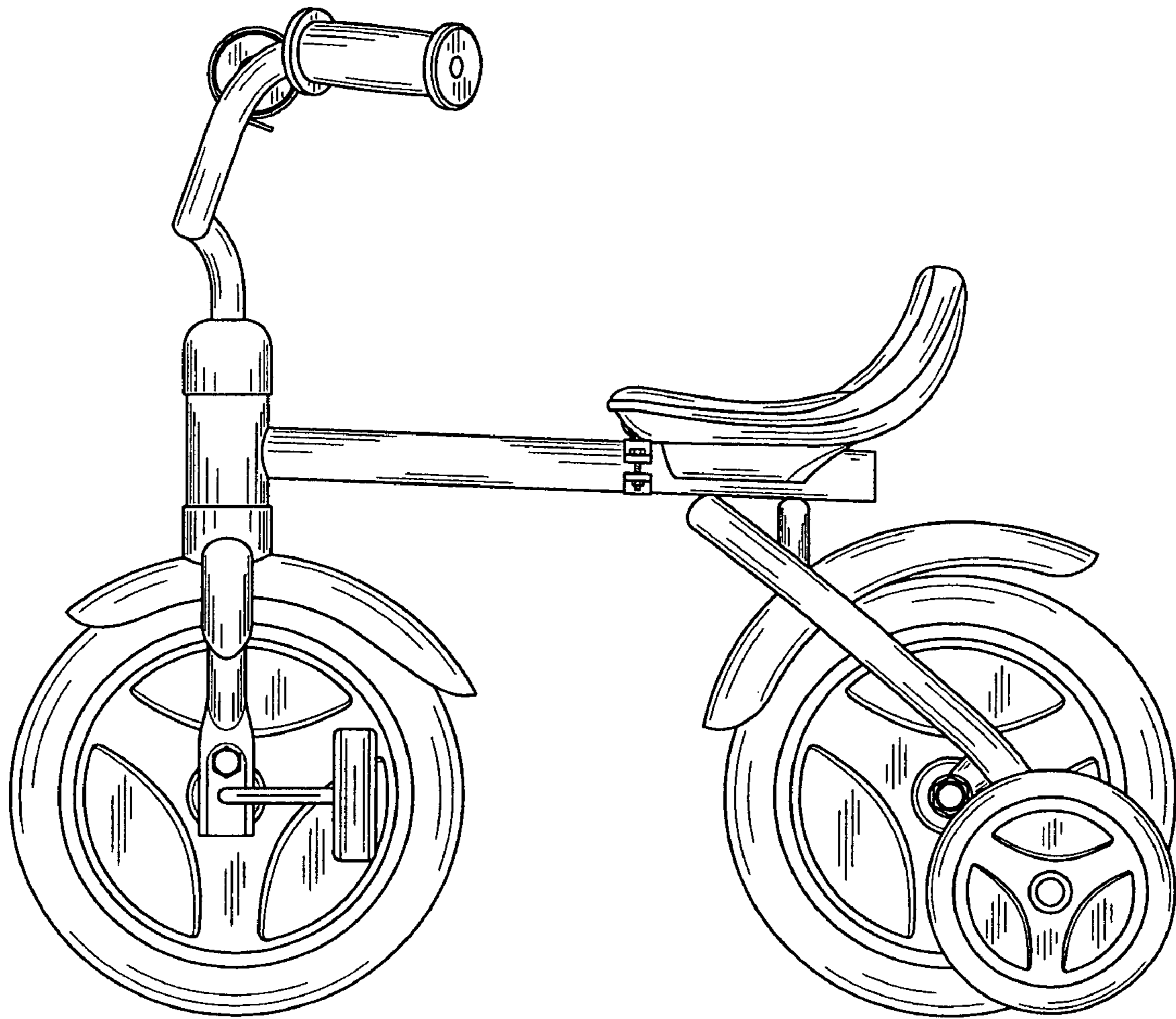

FIG. 4

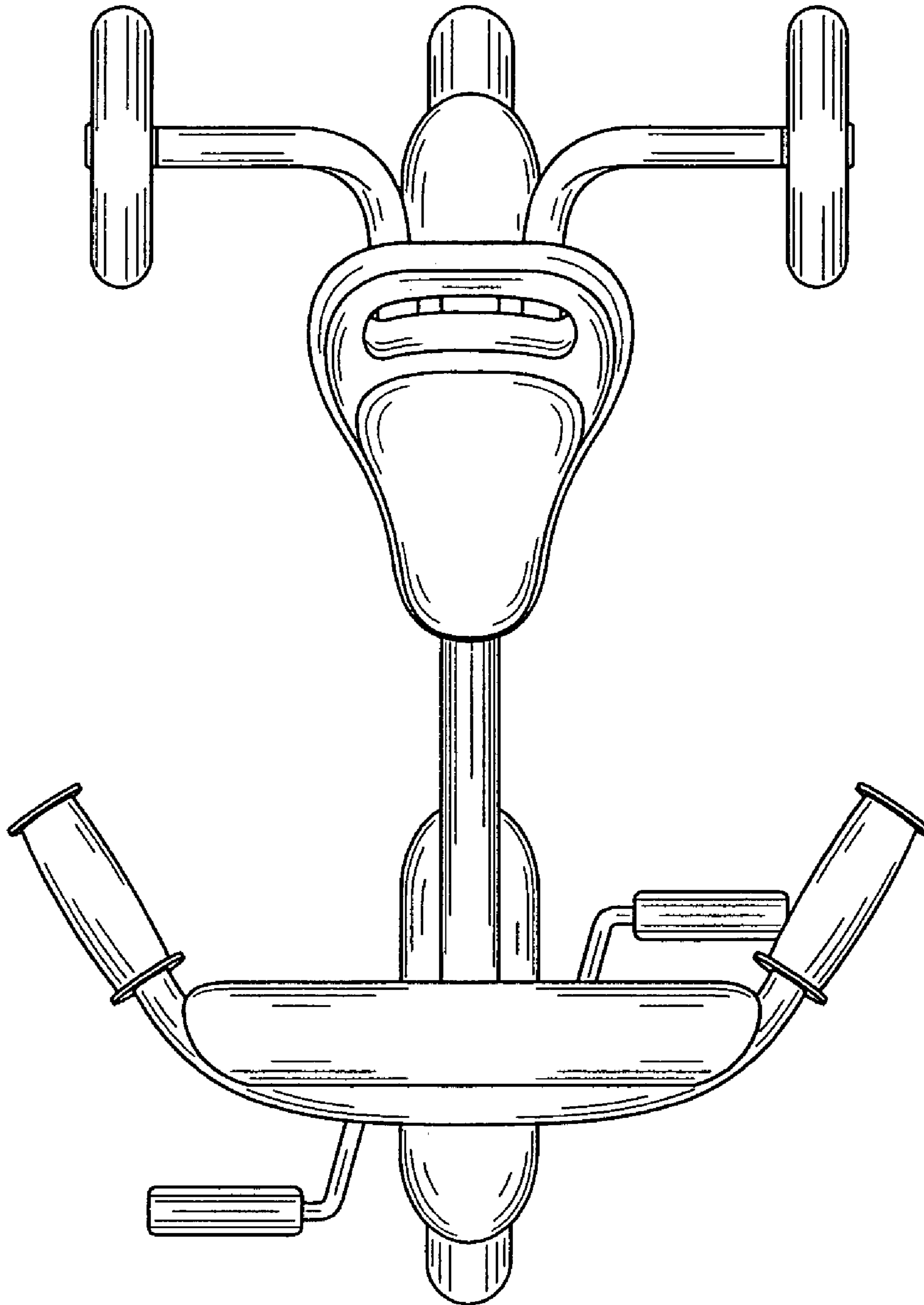

FIG. 5

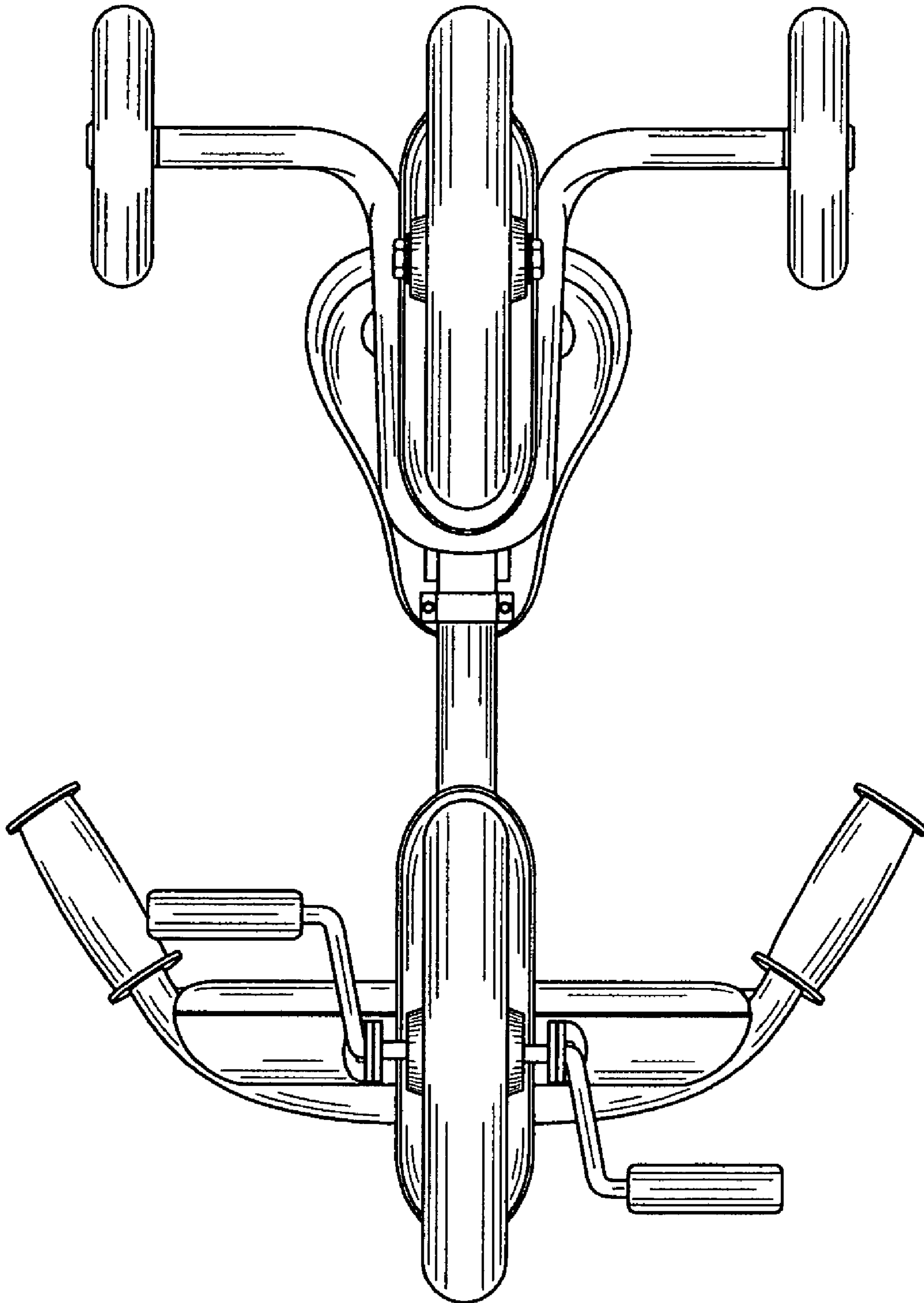

FIG. 6

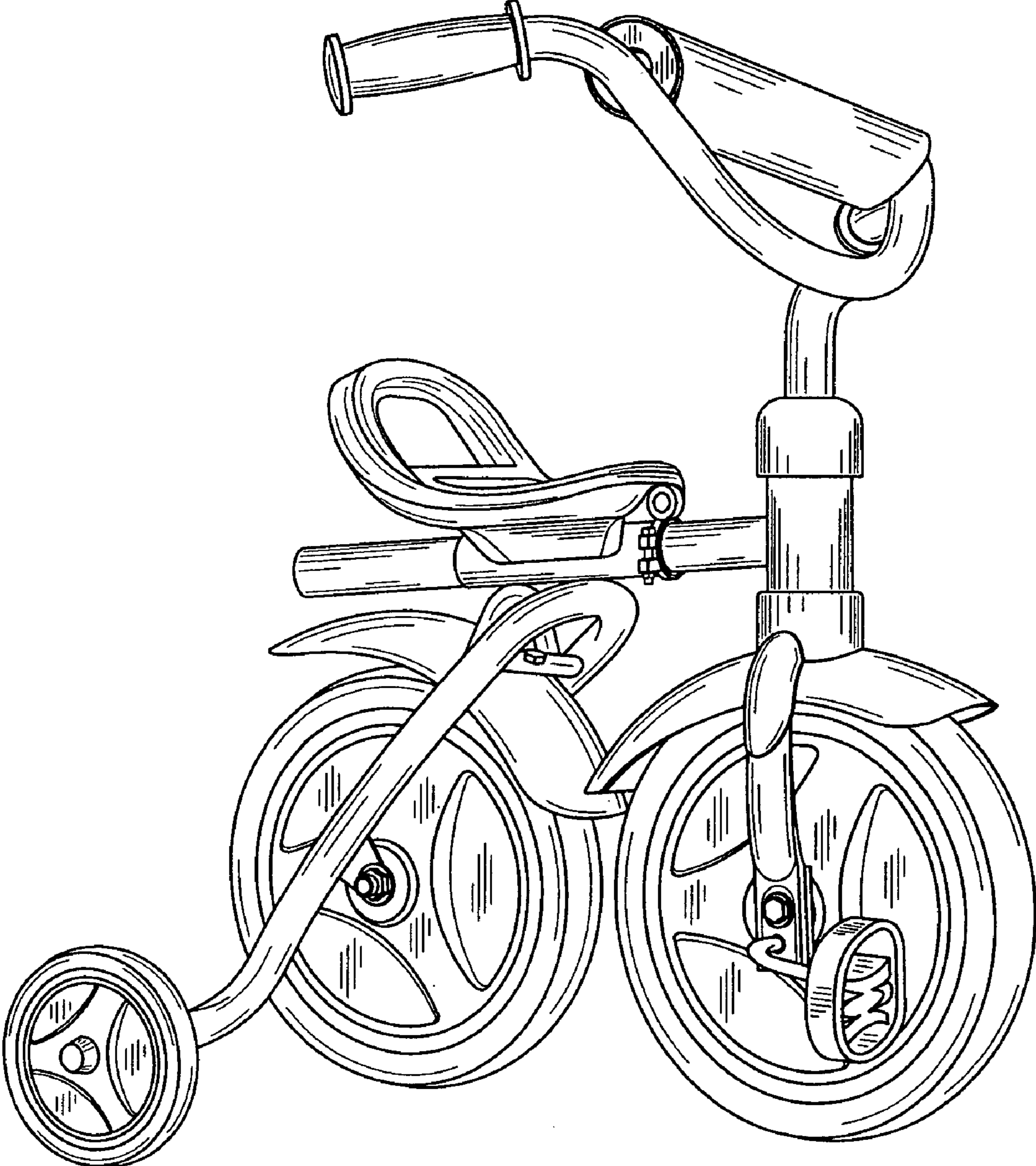

FIG. 7