



US00D558581S

(12) **United States Design Patent**
Lockman et al.

(10) **Patent No.:** **US D558,581 S**

(45) **Date of Patent:** **** Jan. 1, 2008**

(54) **BOTTLE**

(75) Inventors: **Corey Douglas Lockman**, West
Harrison, NY (US); **Pete Mackinson**,
Wyckorr, NJ (US); **John Cieslak**,
Mahwah, NJ (US); **Piaras deCleir**,
Sleepy Hollow, NY (US); **Niketa**
Mohler, Ossining, NY (US)

(73) Assignee: **Kraft Foods Holdings, Inc.**, Northfield,
IL (US)

(**) Term: **14 Years**

(21) Appl. No.: **29/228,099**

(22) Filed: **Apr. 20, 2005**

(51) **LOC (8) Cl.** **09-01**

(52) **U.S. Cl.** **D9/550; D9/552; D9/557**

(58) **Field of Classification Search** D9/600,
D9/640, 649, 667-668, 670, 681, 772-776,
D9/779-780, 516, 537-540, 545-547, 549,
D9/551-554, 556-558, 564-567, 569; D7/509-510;
215/382-384, 396, 398

See application file for complete search history.

(56) **References Cited**

U.S. PATENT DOCUMENTS

4,538,439	A	*	9/1985	Frei	220/670	X
D322,936	S	*	1/1992	Maginnis, Jr.	D9/538	
D379,306	S	*	5/1997	Peykoff	D9/557	X
D383,677	S	*	9/1997	Darr	D9/520	
D409,493	S		5/1999	Waggaman et al.			
D409,919	S	*	5/1999	Young	D9/520	
D412,441	S		8/1999	Cheng et al.			
D414,112	S		9/1999	Waggaman et al.			
D417,156	S		11/1999	Veysi			
6,016,932	A		1/2000	Gaydosh et al.			
D424,948	S		5/2000	Ullmo			

D429,151	S		8/2000	Cheng et al.			
D454,073	S		3/2002	Crawford			
D454,500	S		3/2002	Bretz et al.			
D454,790	S		3/2002	Crawford			
D463,292	S		9/2002	Del Bianco			
D480,650	S	*	10/2003	Moore et al.	D9/540	
D493,370	S		7/2004	Kamineni et al.			
D506,139	S	*	6/2005	Zboch et al.	D9/539	
D506,923	S	*	7/2005	Zboch et al.	D9/538	
D510,027	S	*	9/2005	Zboch et al.	D9/516	
D517,417	S	*	3/2006	Livingston et al.	D9/552	
D527,267	S	*	8/2006	Zboch et al.	D9/516	
D527,635	S	*	9/2006	Zboch et al.	D9/516	
D543,462	S	*	5/2007	Pedmo et al.	D9/520	

FOREIGN PATENT DOCUMENTS

GB	2071168	*	3/1998
GB	3011013	*	6/2003

* cited by examiner

Primary Examiner—Carol Rademaker

(74) *Attorney, Agent, or Firm*—Stites & Harbison PLLC;
Marvin Petry

(57) **CLAIM**

The ornamental design for a bottle, as shown.

DESCRIPTION

FIG. 1 is a top front perspective view of a bottle according to our new design;

FIG. 2 is a front elevational view thereof;

FIG. 3 is a rear elevational view thereof;

FIG. 4 is a right side elevational view thereof;

FIG. 5 is a left side elevational view thereof; and,

FIG. 6 is a top plan view thereof.

1 Claim, 6 Drawing Sheets

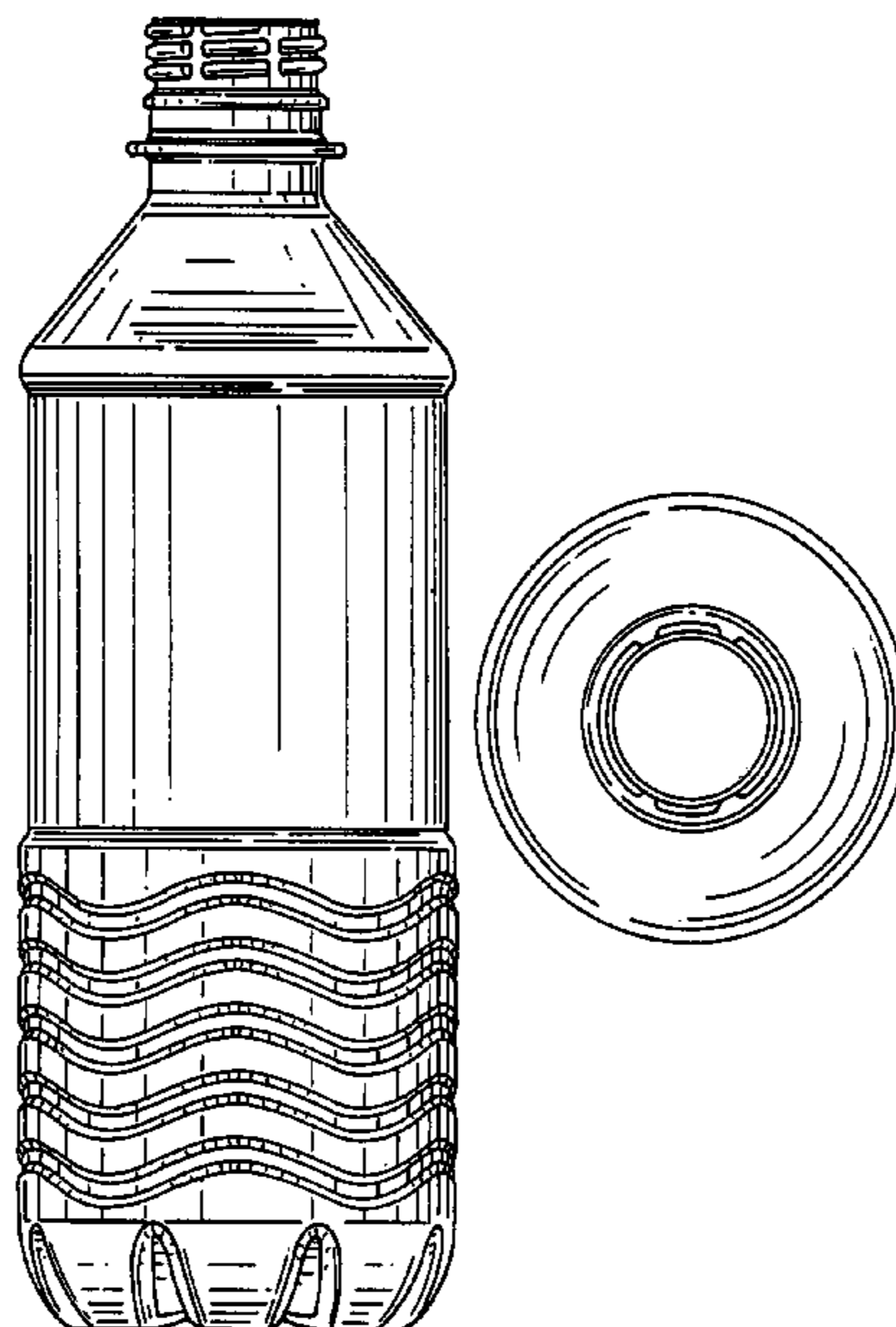

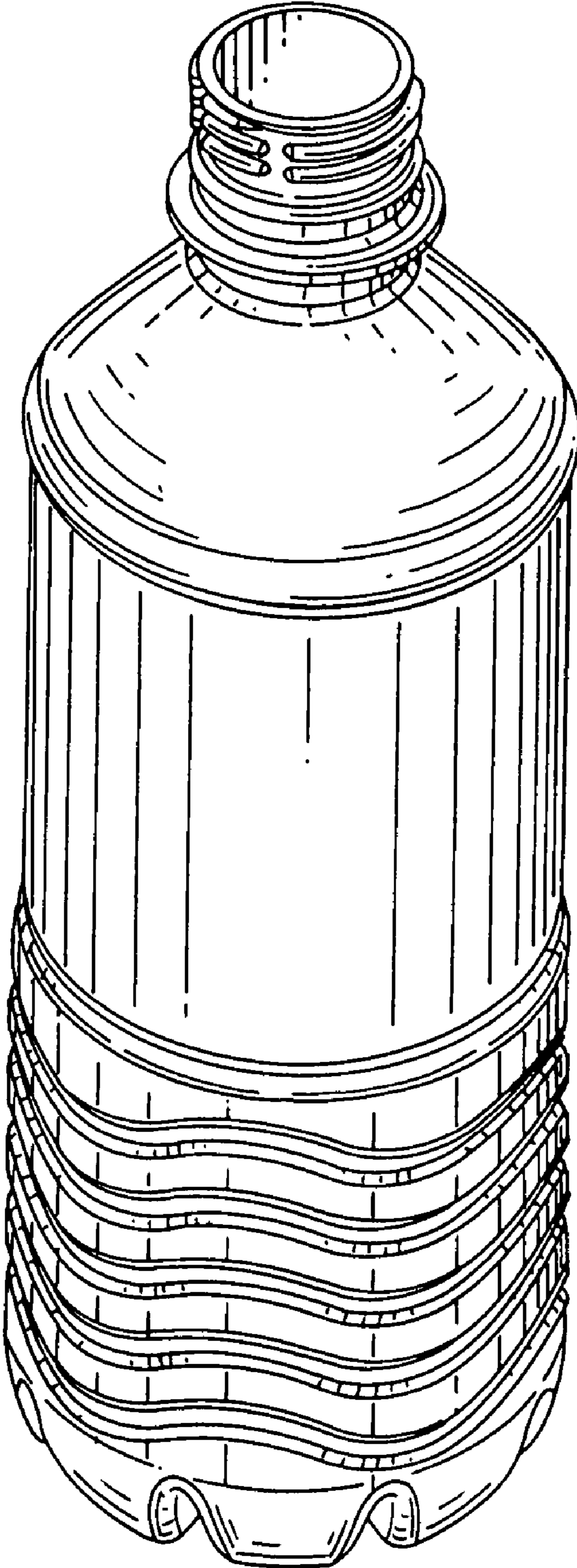

FIG. 1

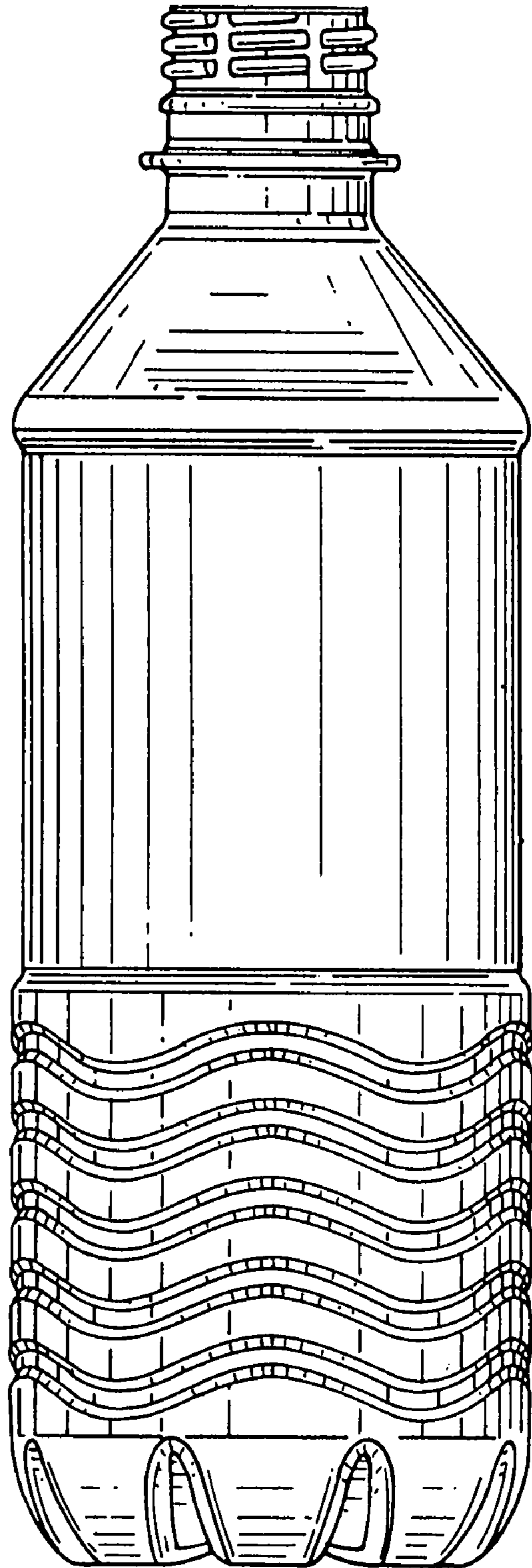

FIG. 2

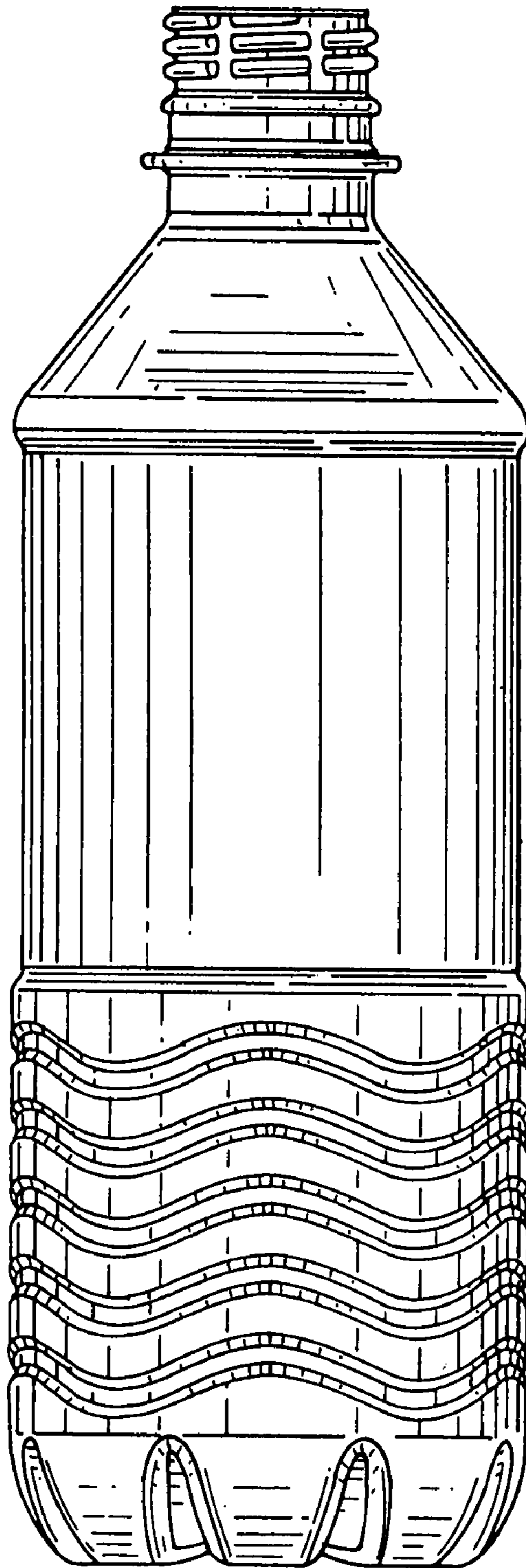

FIG. 3

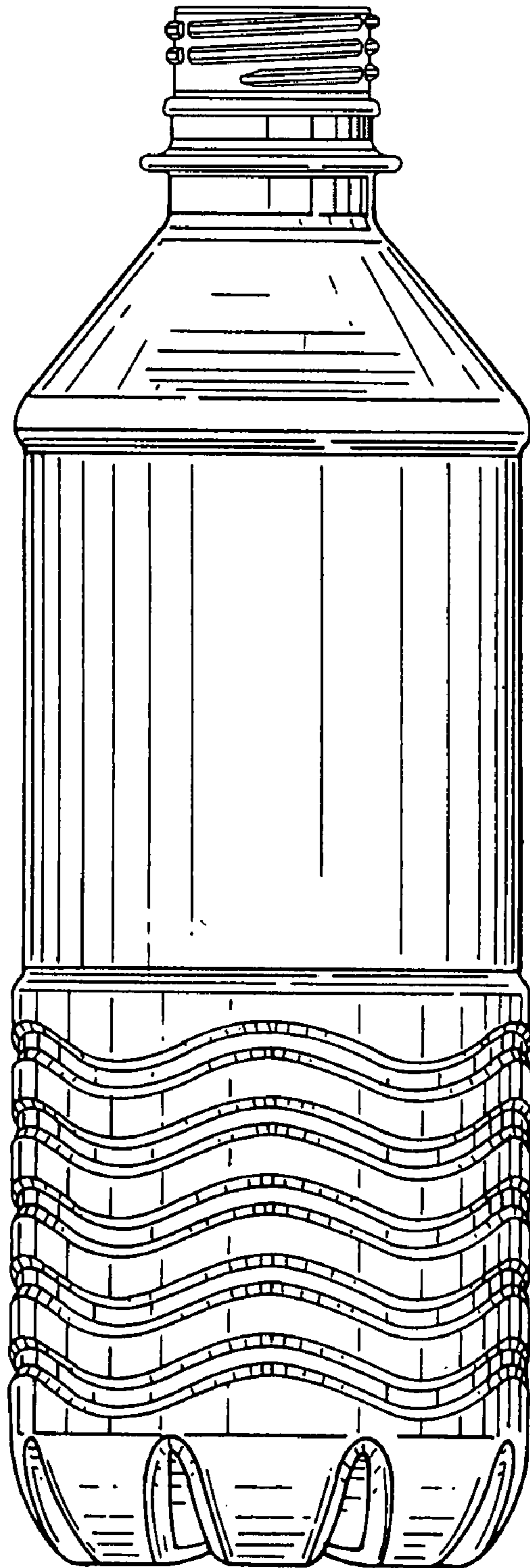

FIG. 4

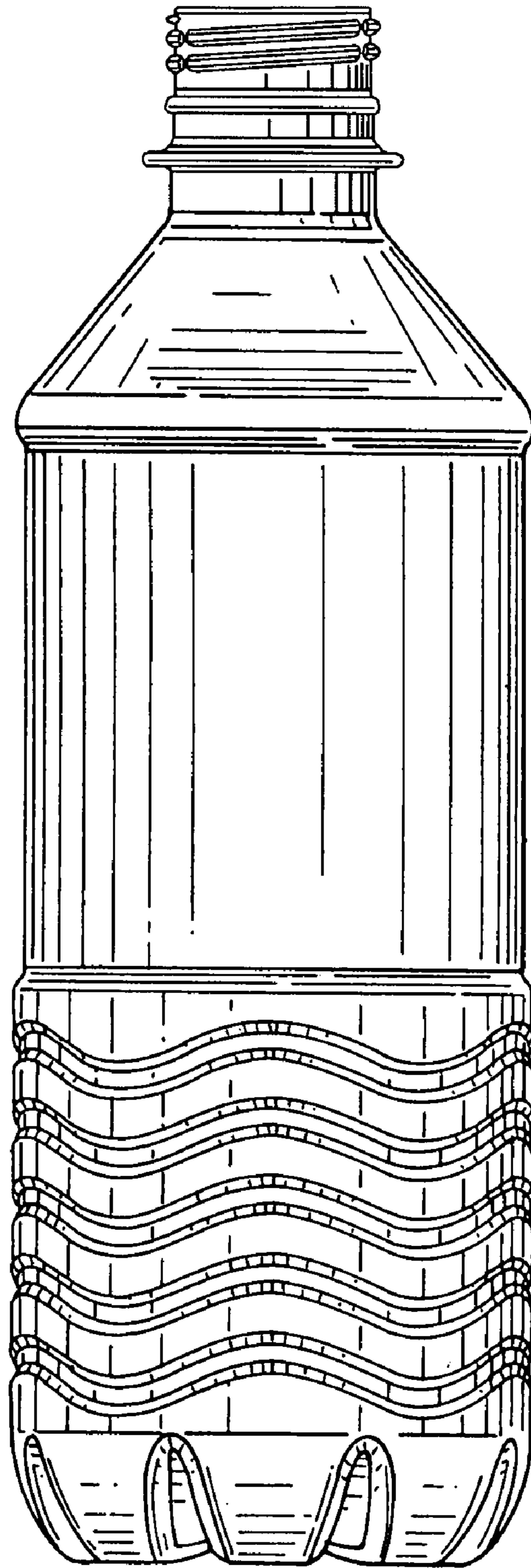

FIG. 5

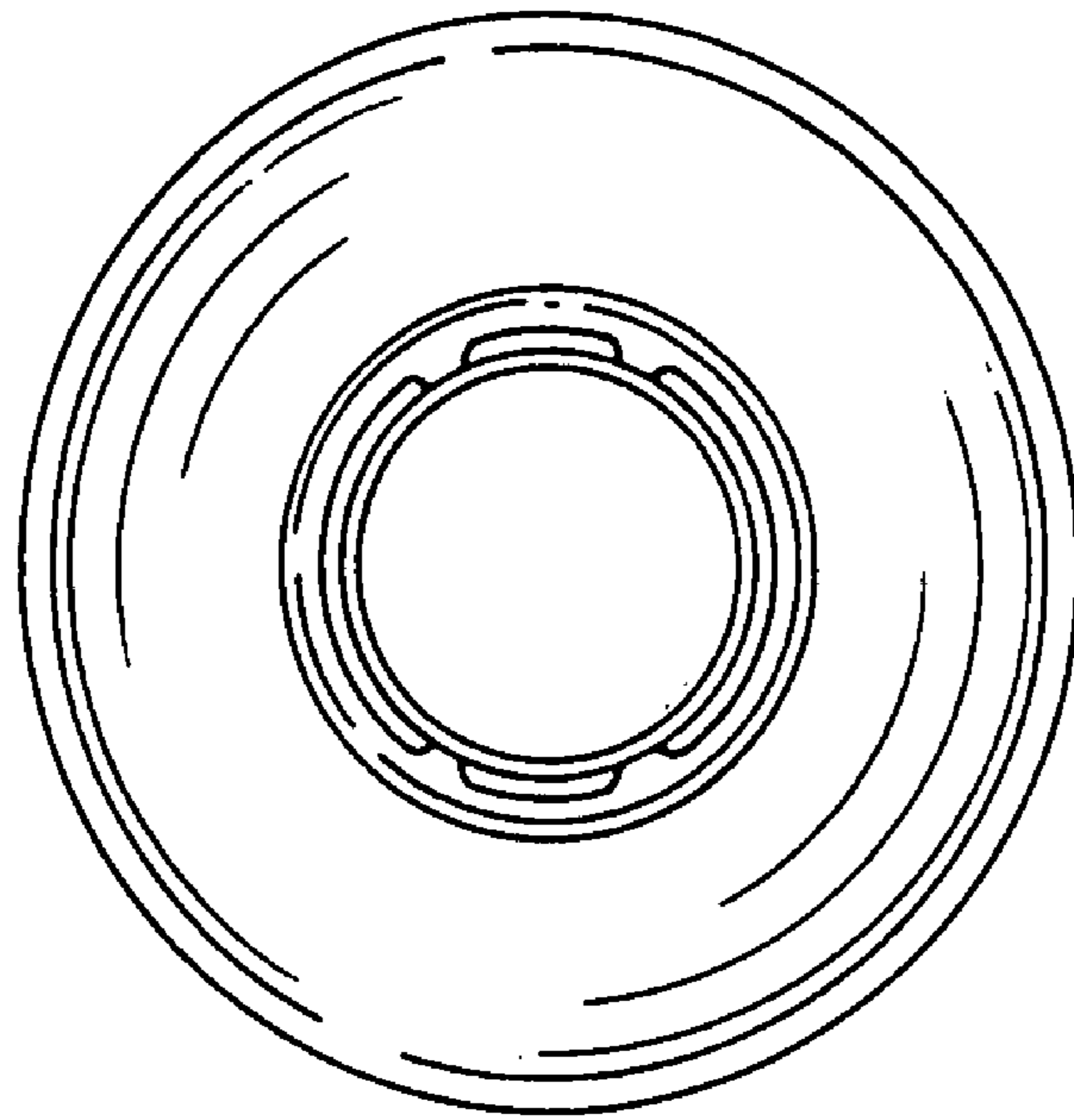

FIG. 6