



US00D558454S

(12) **United States Design Patent**
Tracy

(10) **Patent No.:** **US D558,454 S**

(45) **Date of Patent:** **** Jan. 1, 2008**

(54) **WEB END CLIP**

(75) Inventor: **Richard J. Tracy**, Elgin, IL (US)

(73) Assignee: **Illinois Tool Works Inc.**, Glenview, IL (US)

(**) Term: **14 Years**

(21) Appl. No.: **29/231,291**

(22) Filed: **Jun. 2, 2005**

Related U.S. Application Data

(63) Continuation of application No. 10/715,151, filed on Nov. 17, 2003, now Pat. No. 7,013,535.

(51) **LOC (8) Cl.** **03-01**

(52) **U.S. Cl.** **D3/318**

(58) **Field of Classification Search** D3/237,
D3/318; D2/627, 629, 631, 635, 639, 640;
24/3.1, 3.12, 3.13, 3.4, 115 H, 115 R, 129 R,
24/265 H, 265 R, 265 BC; 40/1.5; 224/258;
361/814; 455/351

See application file for complete search history.

(56) **References Cited**

U.S. PATENT DOCUMENTS

| | | | | | | | |
|-----------|----|---|---------|----------------|-------|--------|---|
| 967,664 | A | * | 8/1910 | Peterson | | 24/265 | H |
| 3,034,189 | A | * | 5/1962 | Twentier | | 24/129 | R |
| 3,432,895 | A | * | 3/1969 | Yost et al. | | 24/265 | R |
| 4,038,726 | A | | 8/1977 | Takabayashi | | 24/198 | |
| D363,592 | S | * | 10/1995 | Gold | | D3/327 | |
| 5,669,119 | A | | 9/1997 | Seron | | 24/265 | H |
| 5,842,256 | A | | 12/1998 | Anscher | | 24/3.4 | |
| D422,142 | S | * | 4/2000 | Hicks et al. | | D3/318 | |
| D426,063 | S | * | 6/2000 | Hicks et al. | | D3/318 | |
| D433,917 | S | * | 11/2000 | Frey | | D8/306 | |
| 6,351,874 | B1 | * | 3/2002 | Suggs | | 24/265 | R |
| 6,453,519 | B1 | | 9/2002 | Gelardi | | 24/163 | R |
| 6,868,585 | B2 | * | 3/2005 | Anthony et al. | | 24/134 | R |

* cited by examiner

Primary Examiner—Louis S. Zarfes

Assistant Examiner—Monica A. Weingart

(74) *Attorney, Agent, or Firm*—Mark W. Croll; Paul F. Donovan

(57) **CLAIM**

The ornamental design for a web end clip, as shown and described.

DESCRIPTION

FIG. 1 is a top perspective view of a web end clip showing my new design;

FIG. 2 is a top plan view thereof;

FIG. 3 is a bottom plan view thereof;

FIG. 4 is a rear elevational view thereof;

FIG. 5 is a front elevational view thereof;

FIG. 6 is a right side elevational view, the left side being a mirror image thereof;

FIG. 7 is a top perspective view of a second embodiment thereof;

FIG. 8 is a top plan view thereof;

FIG. 9 is a bottom plan view thereof;

FIG. 10 is a rear elevational view thereof;

FIG. 11 is a front elevational view thereof;

FIG. 12 is a right side elevational view, the left side being a mirror image thereof;

FIG. 13 is a top perspective view of a third embodiment thereof;

FIG. 14 is top plan view thereof;

FIG. 15 is bottom plan view thereof;

FIG. 16 is a rear elevational view thereof;

FIG. 17 is front elevational view thereof; and,

FIG. 18 is a right side elevational view, the left side being a mirror image thereof.

The broken line showing, in FIGS. 1, 4, 7, 10, 13, and 16, is included for the purpose of illustrating environment and forms no part of the claimed design.

1 Claim, 6 Drawing Sheets

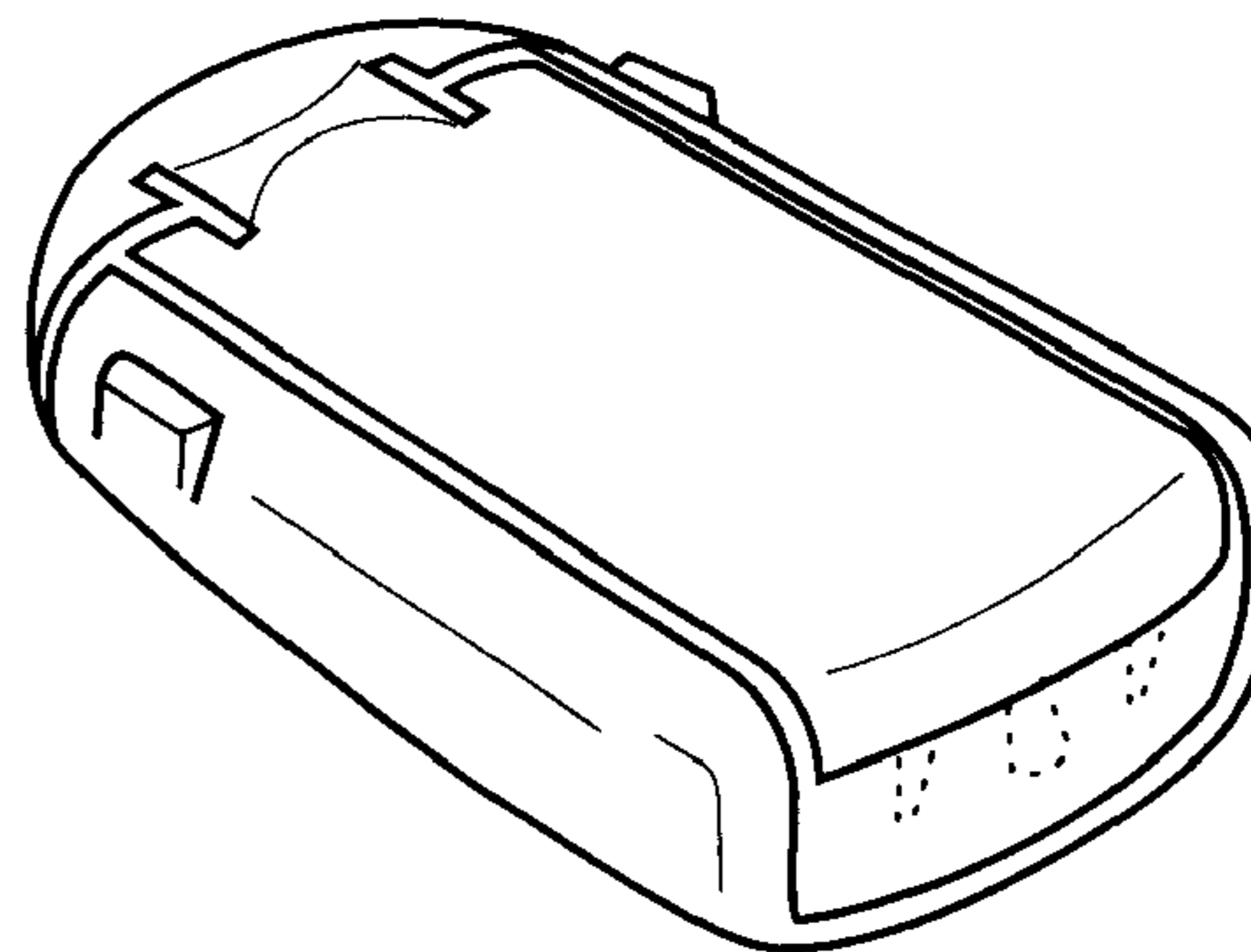
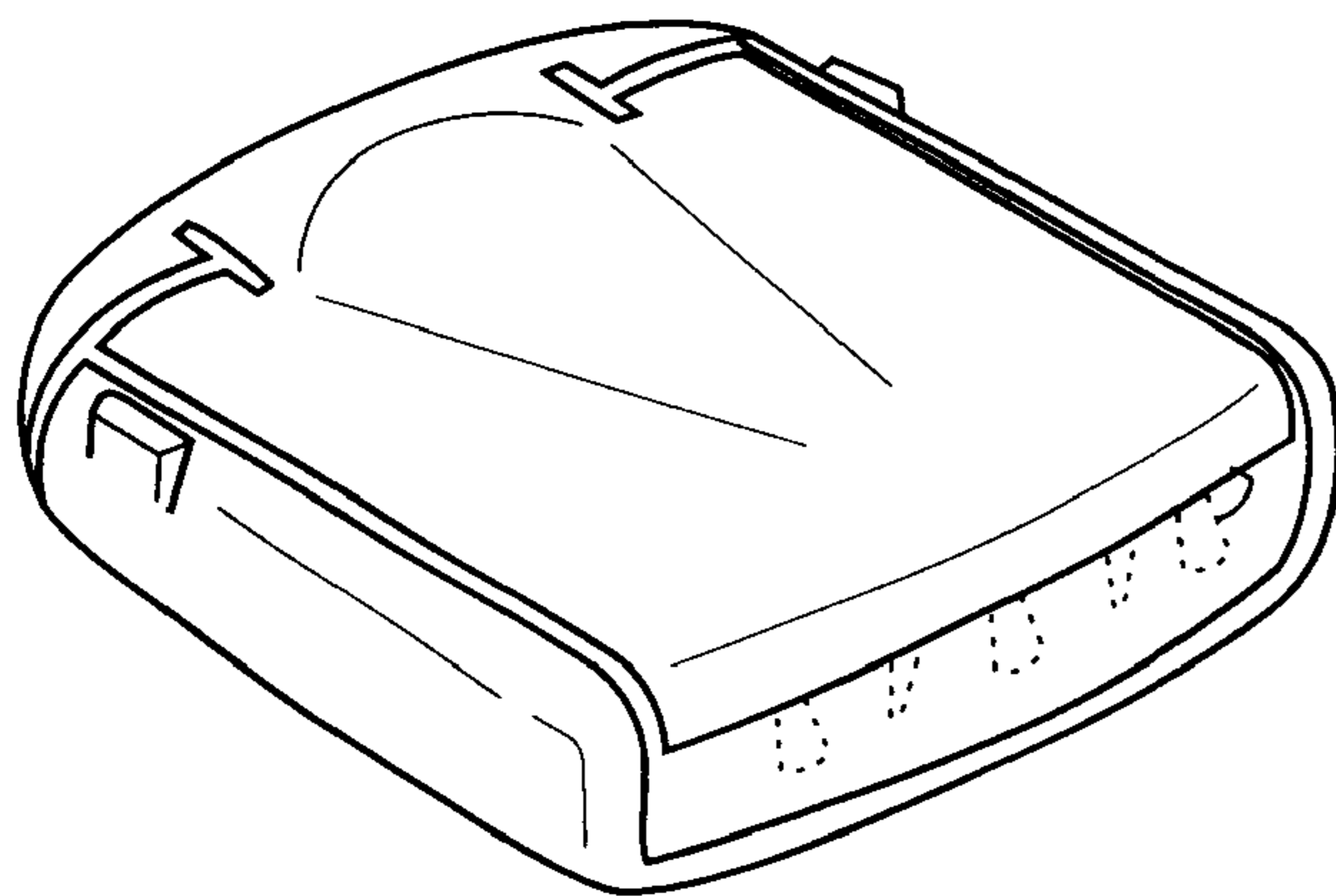

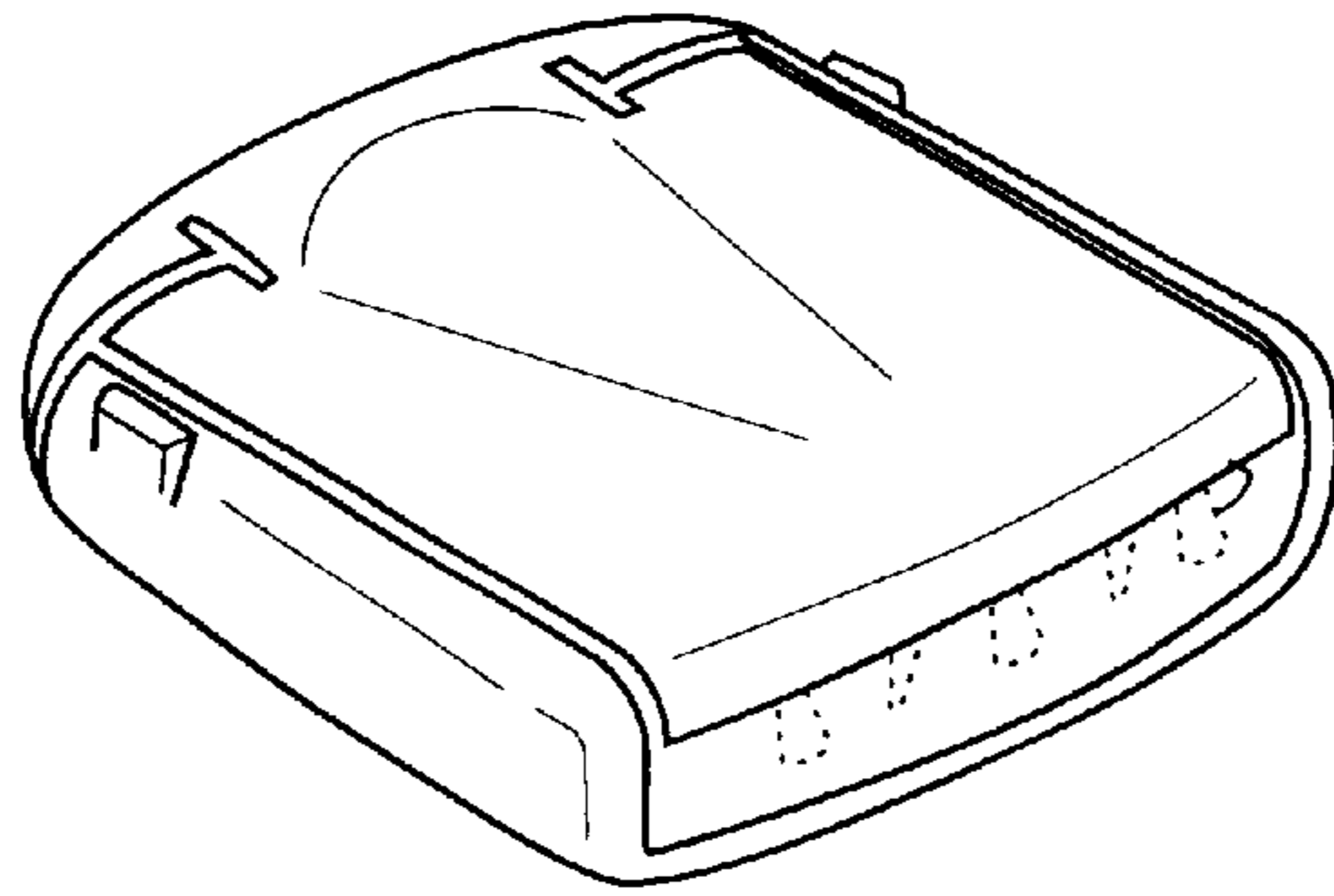

Fig. 1

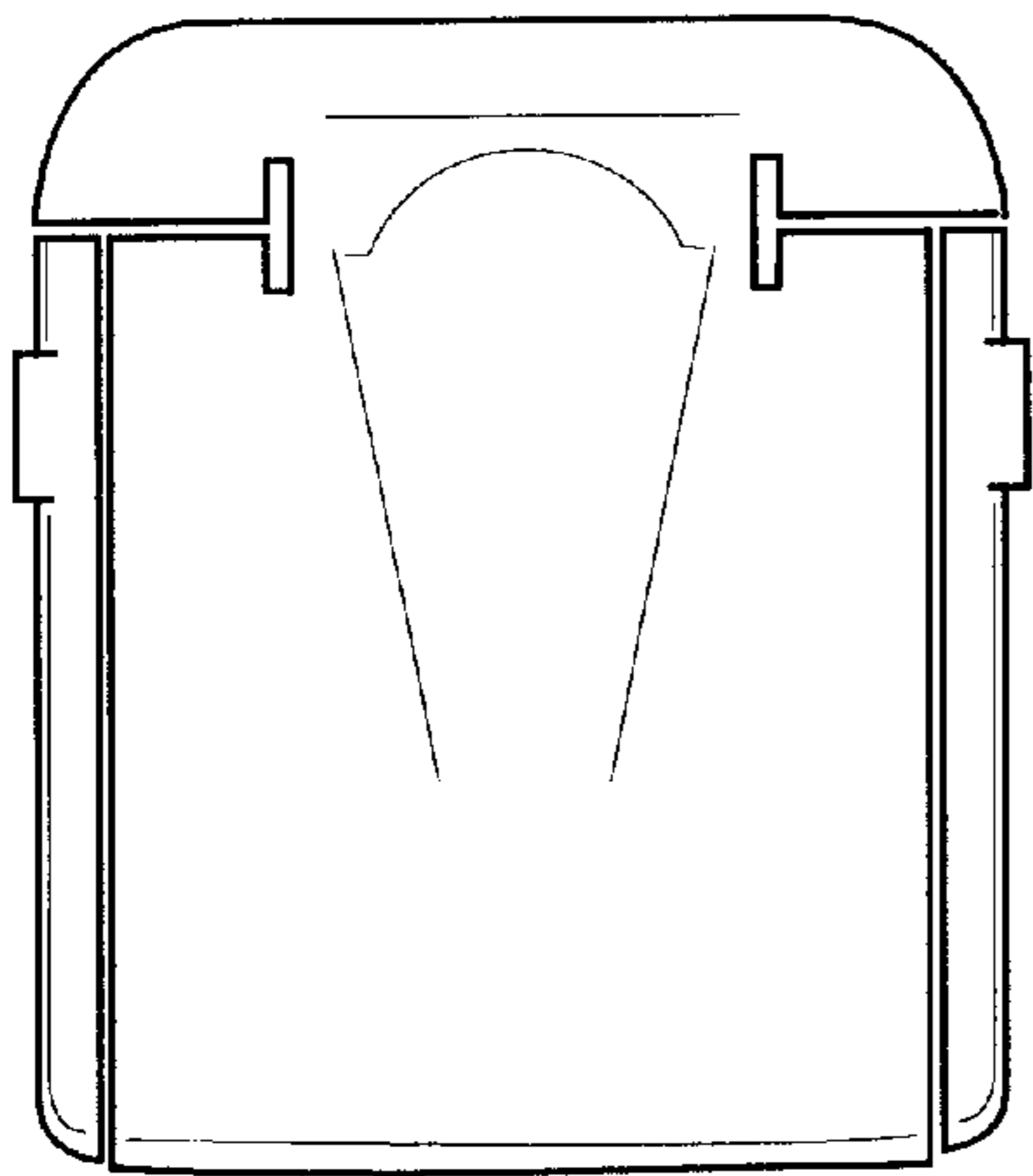

Fig. 2

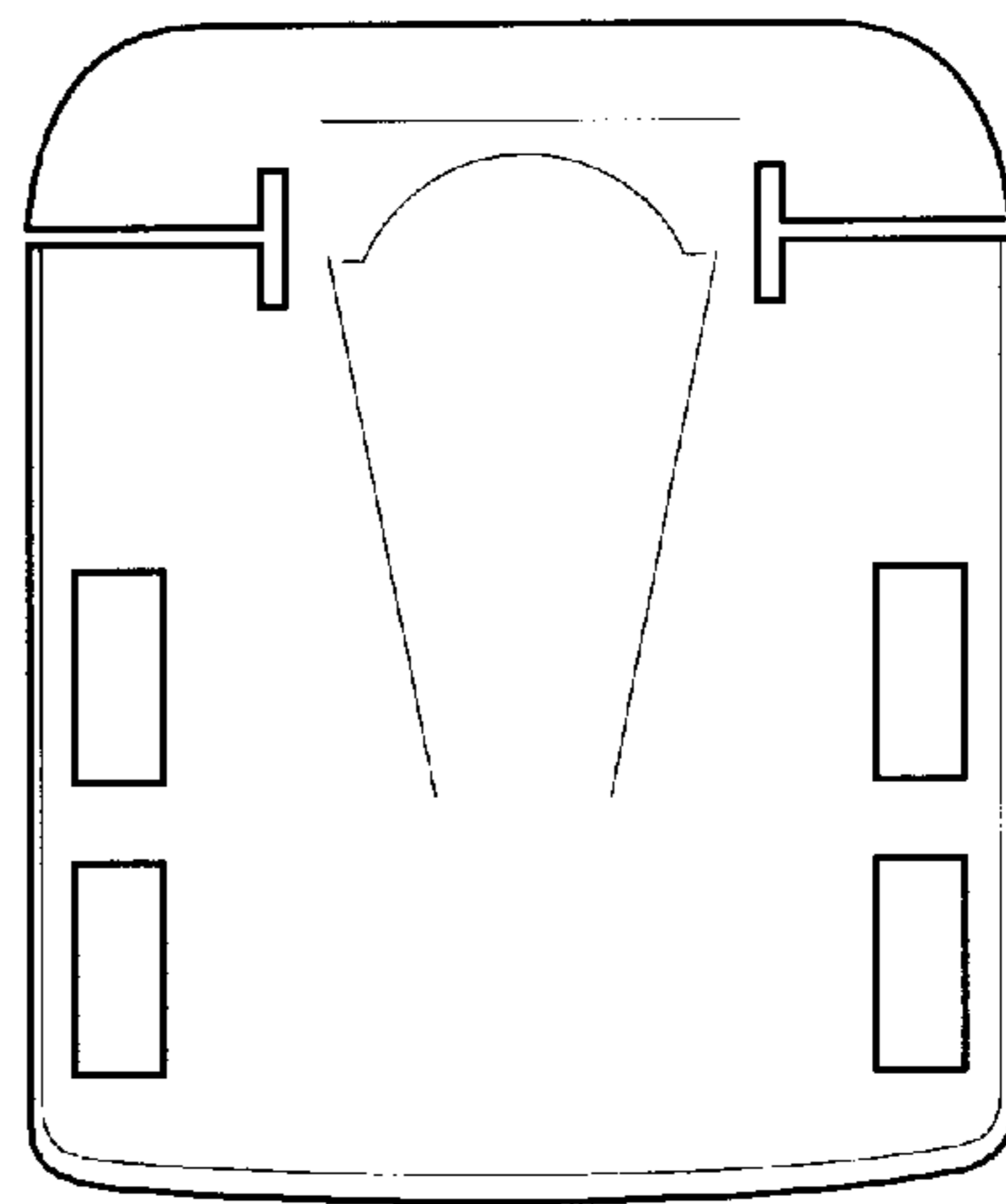

Fig. 3

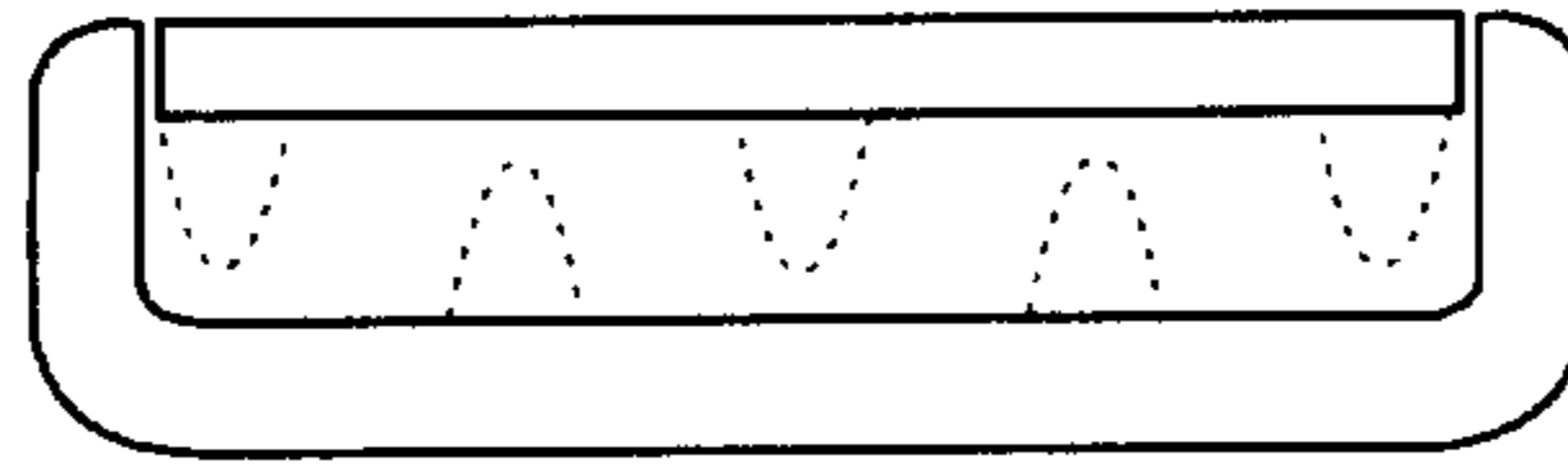

Fig. 4

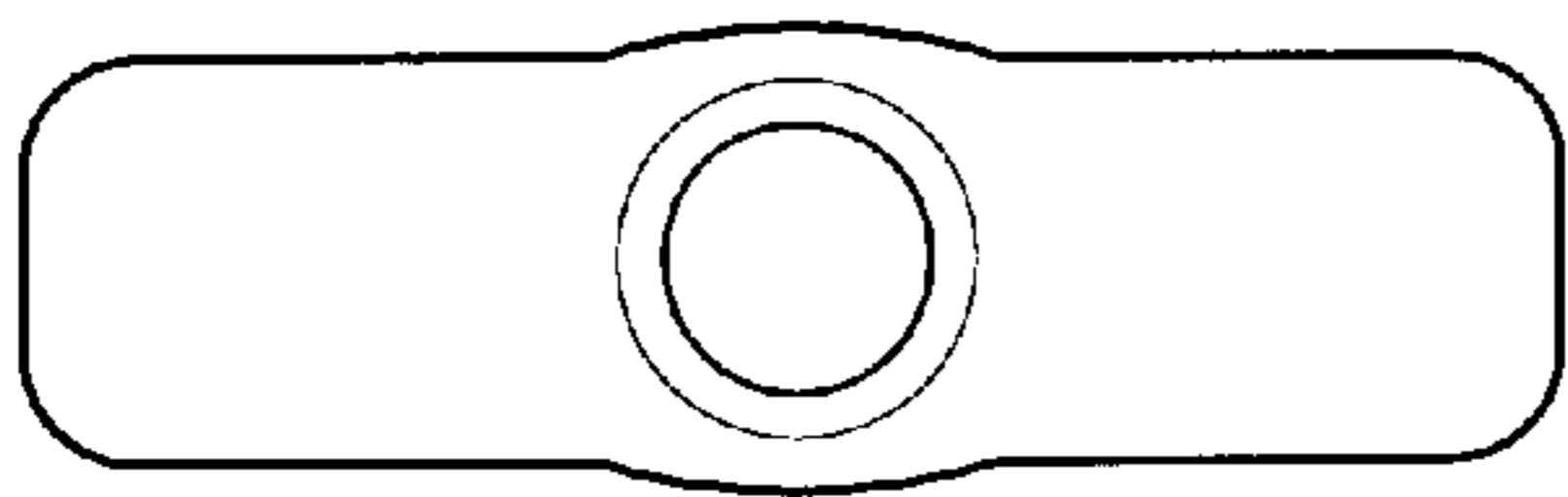

Fig. 5

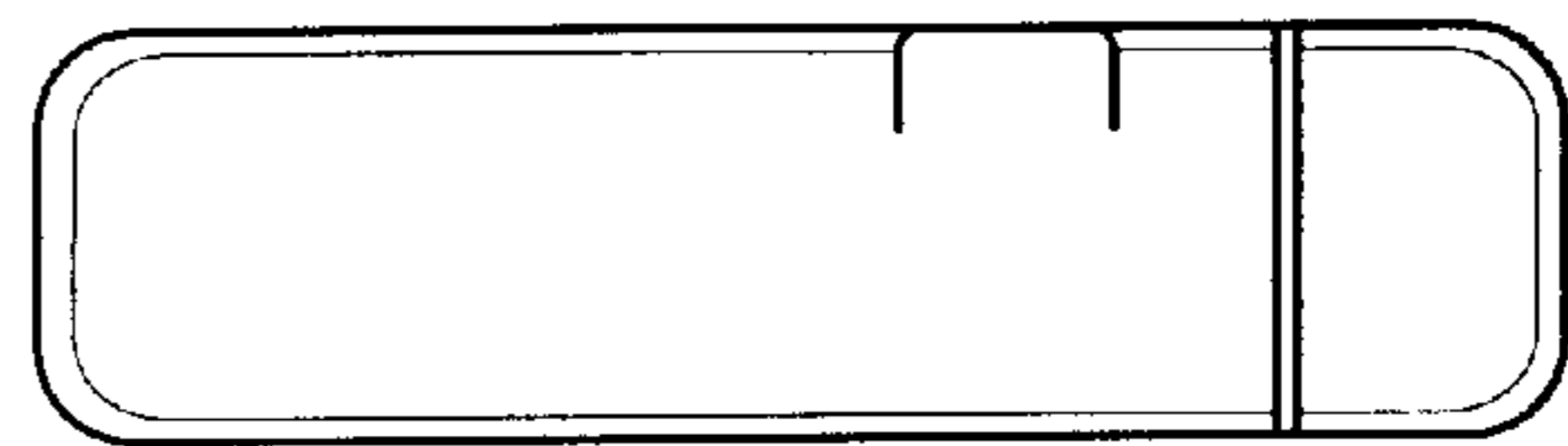

Fig. 6

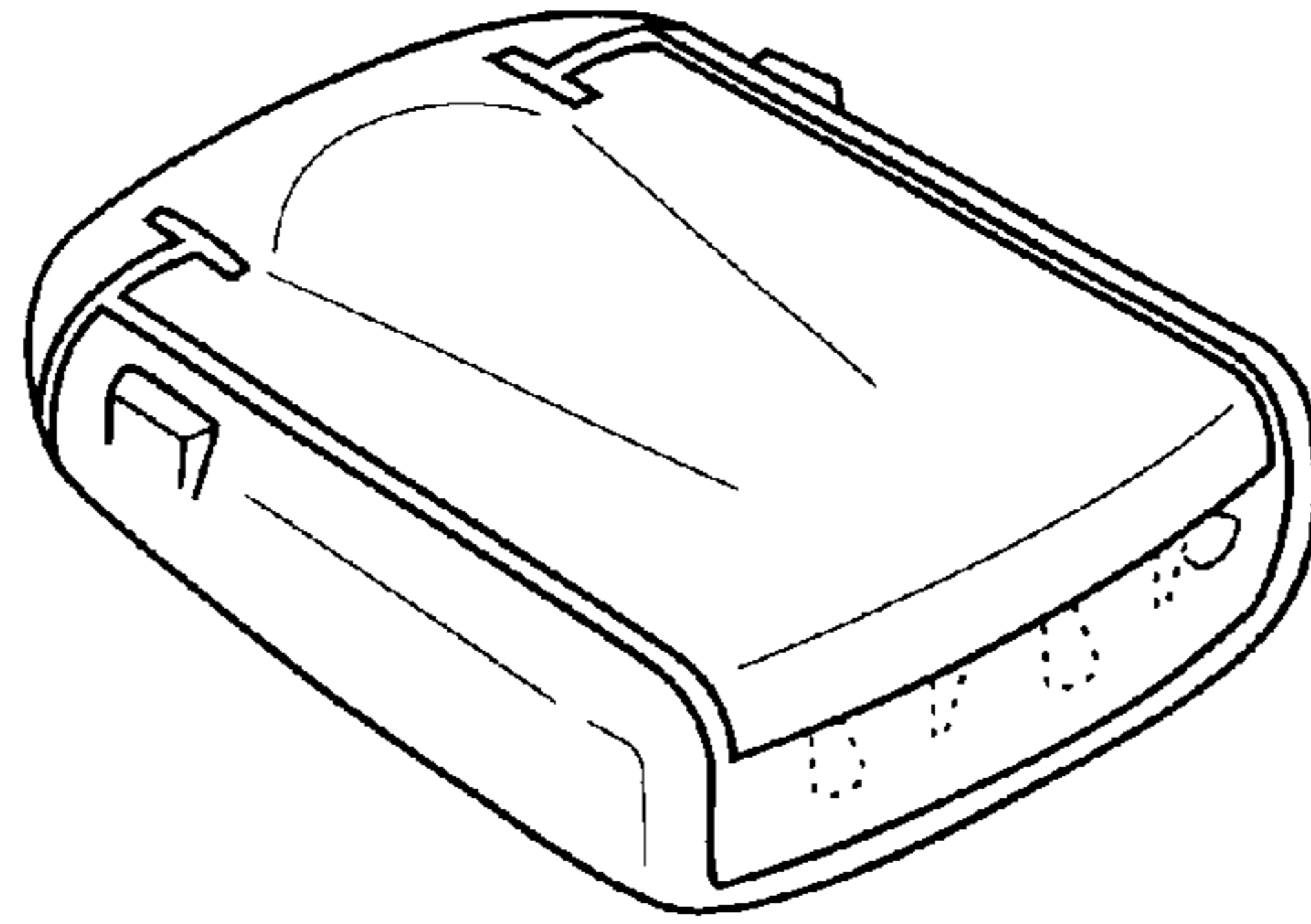

Fig. 7

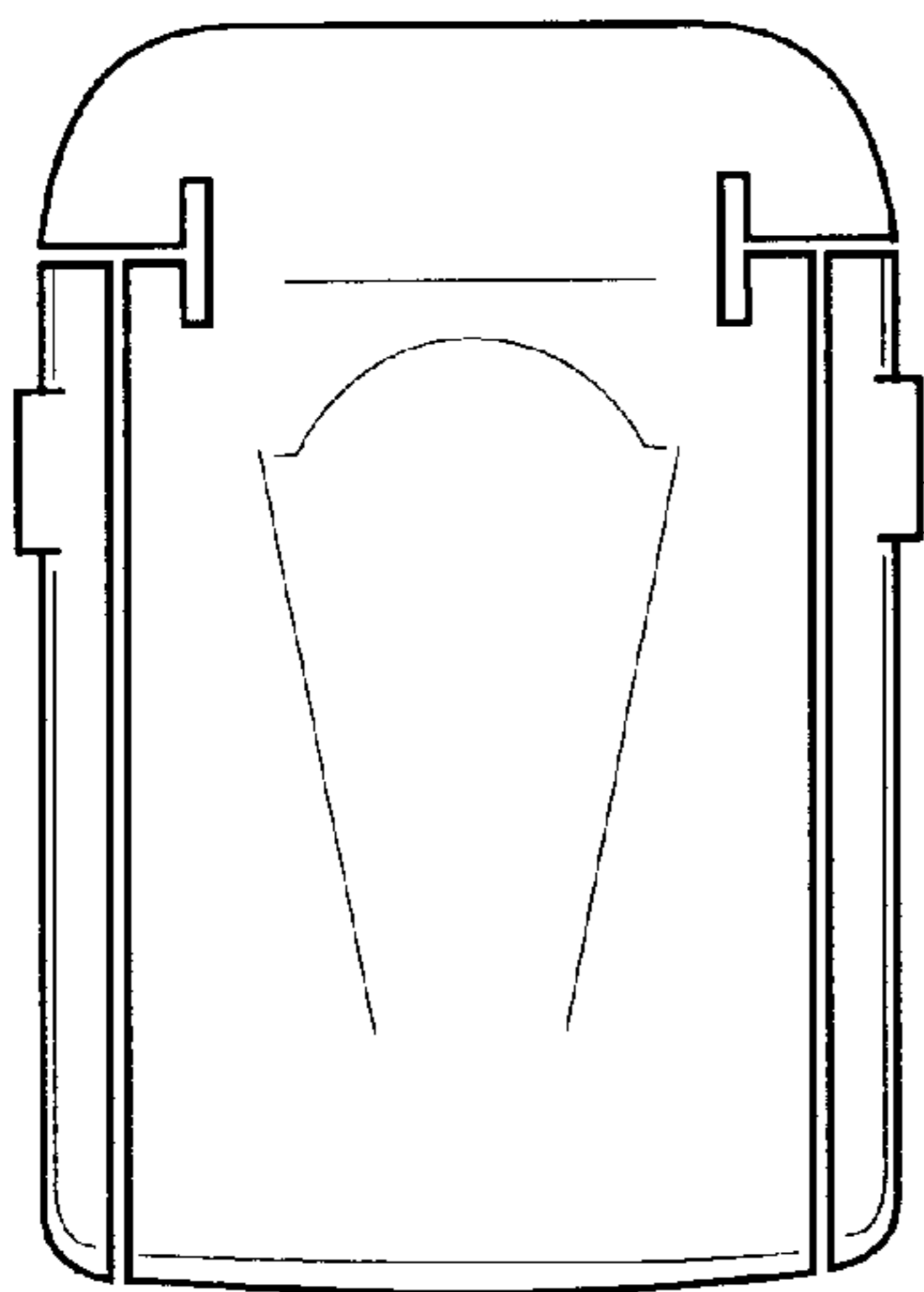

Fig. 8

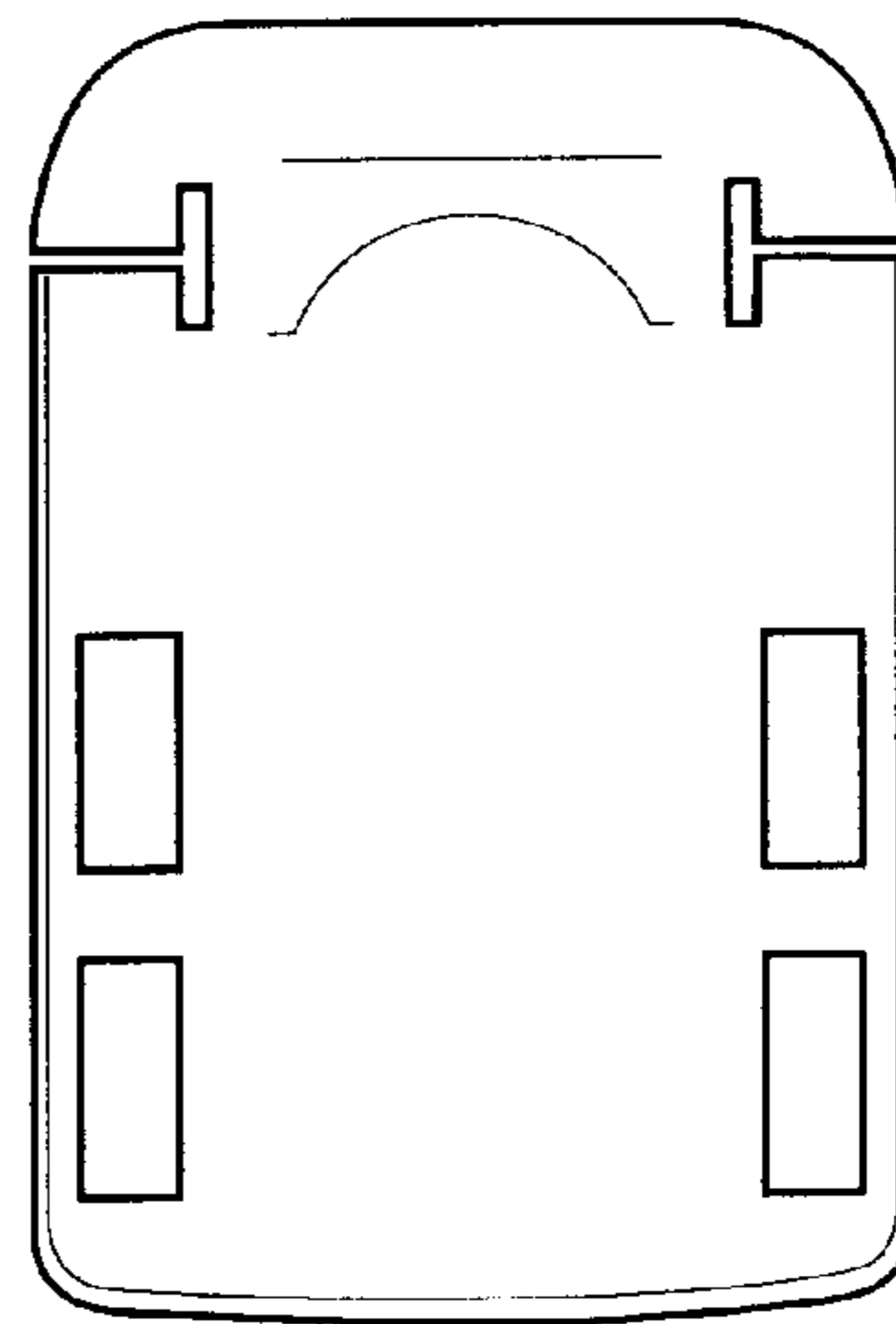

Fig. 9

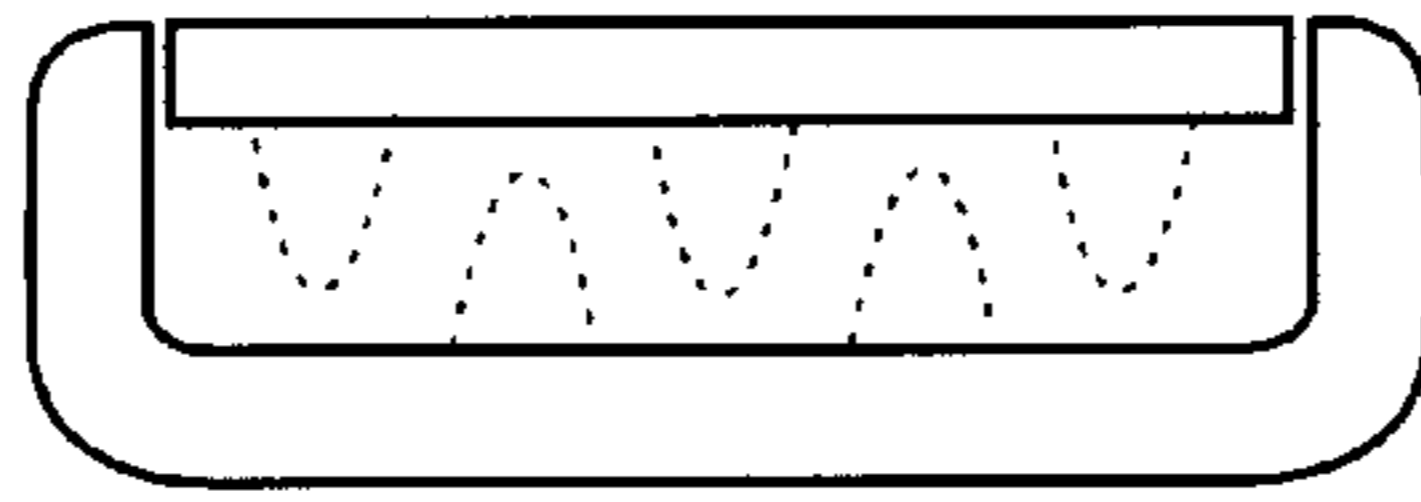

Fig. 10

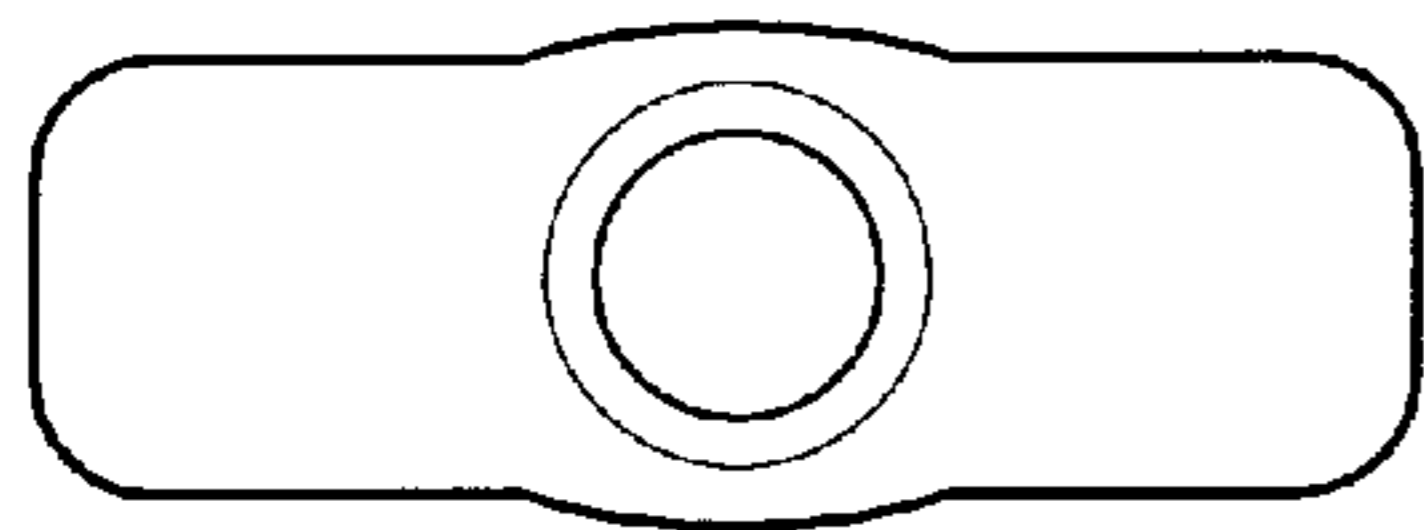

Fig. 11

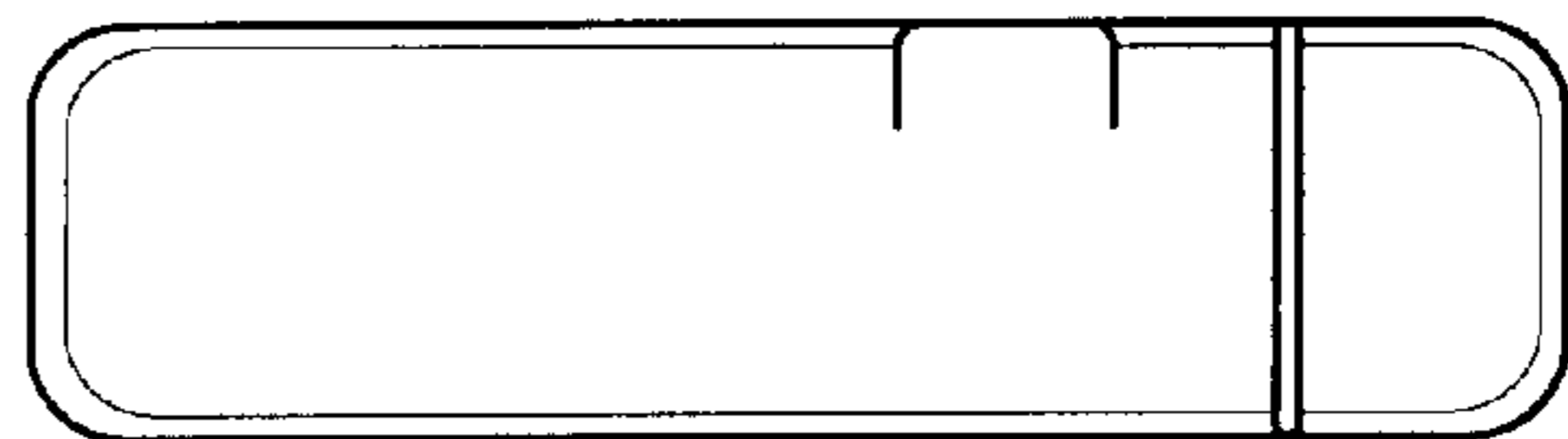

Fig. 12

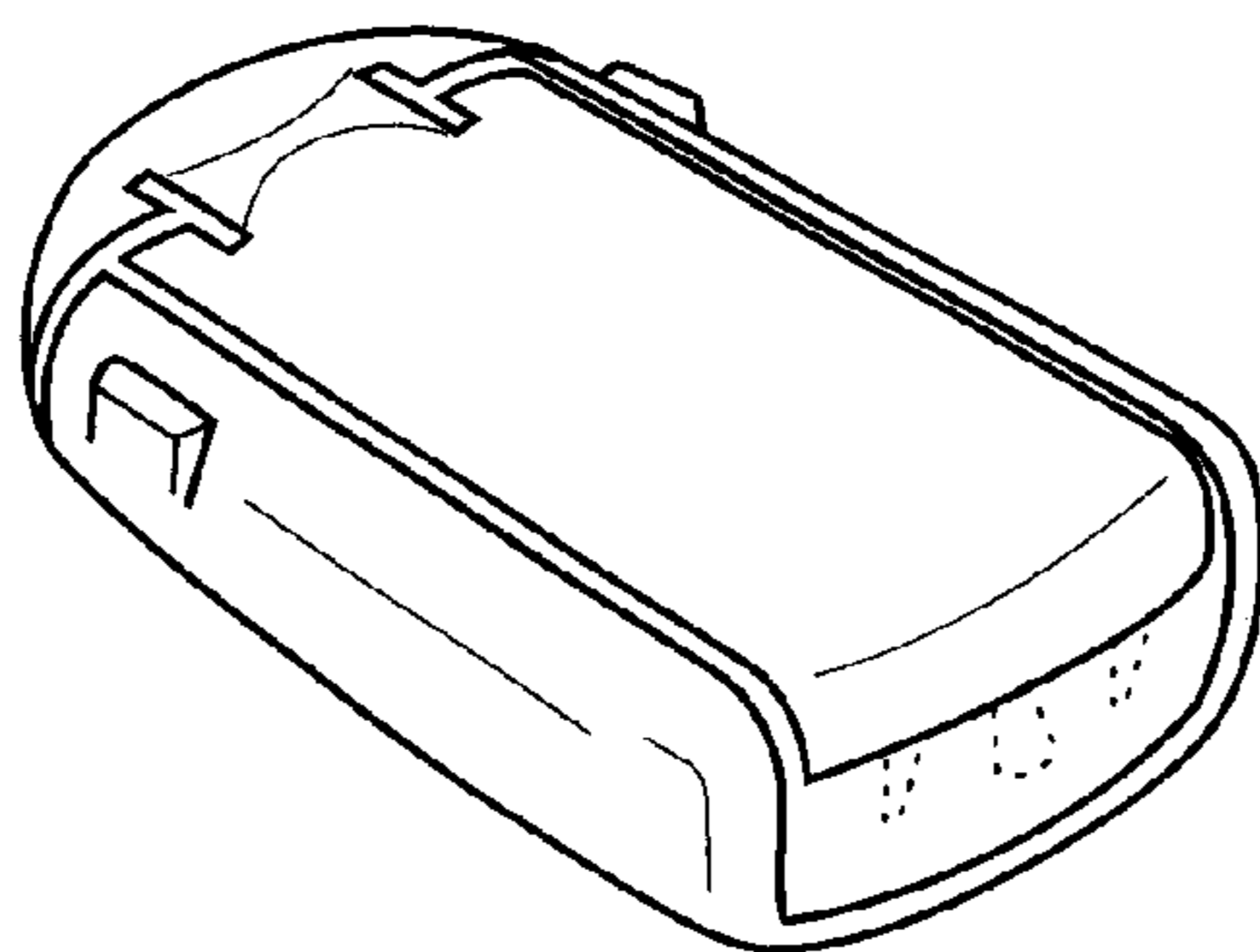

Fig. 13

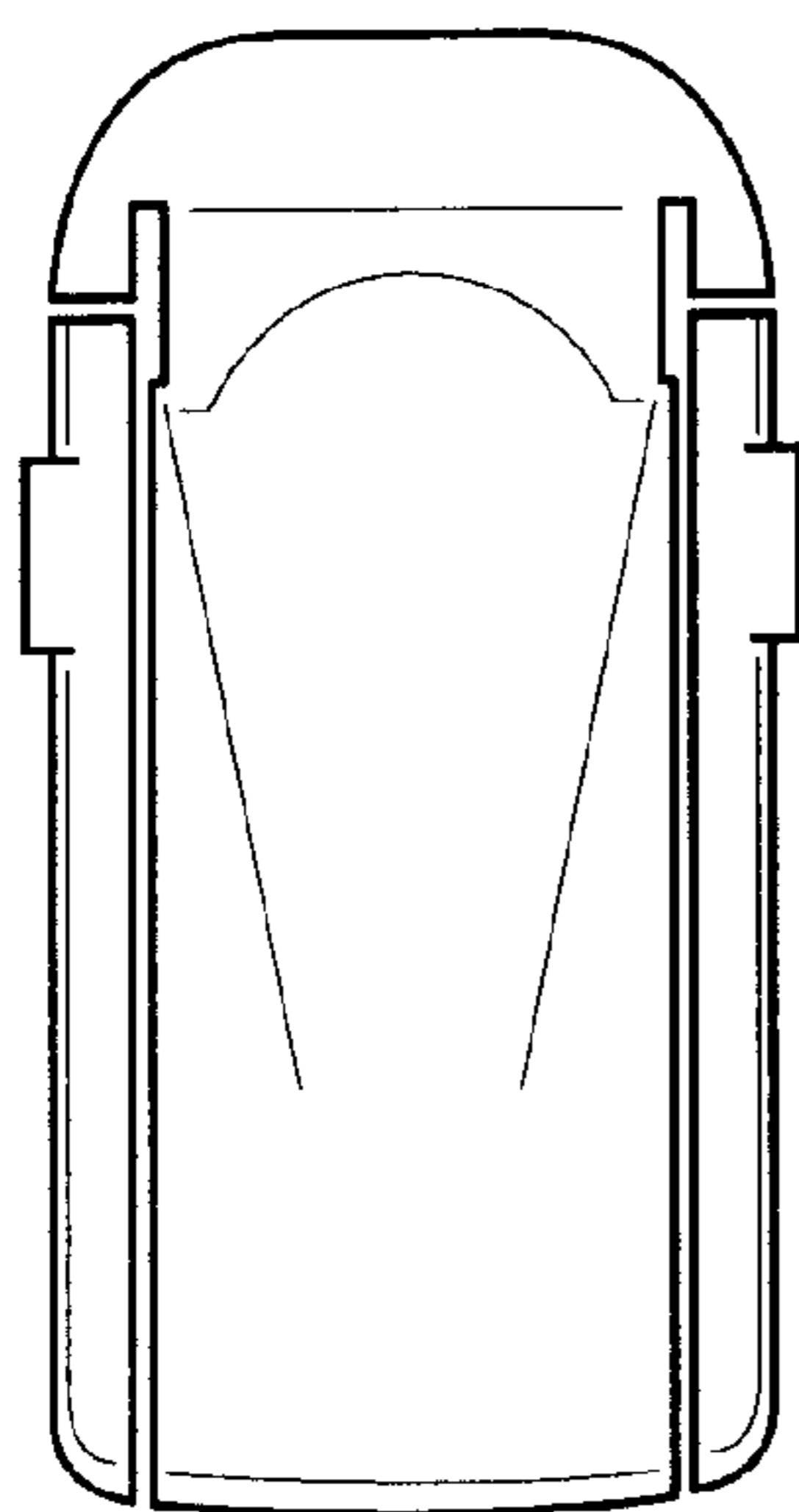

Fig. 14

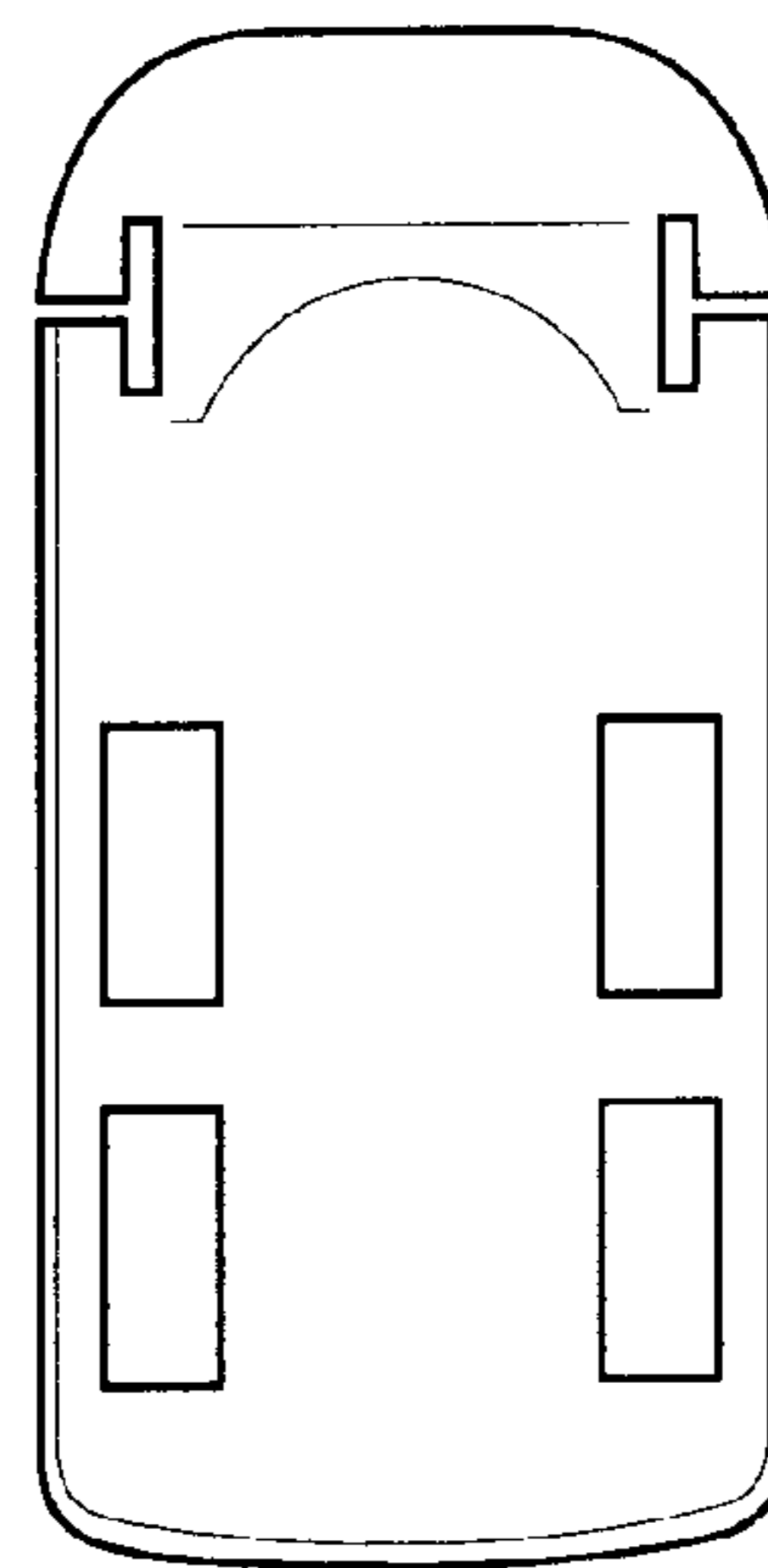

Fig. 15

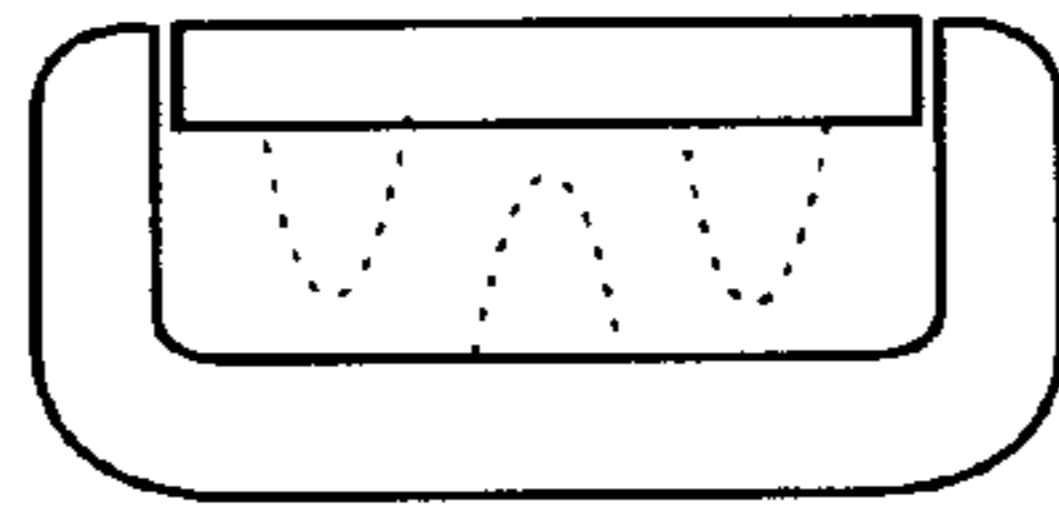

Fig. 16

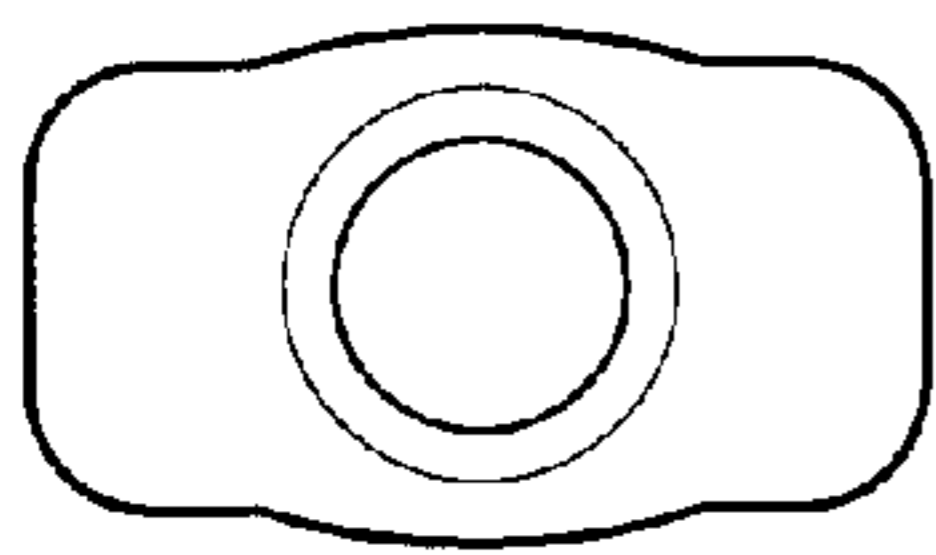

Fig. 17

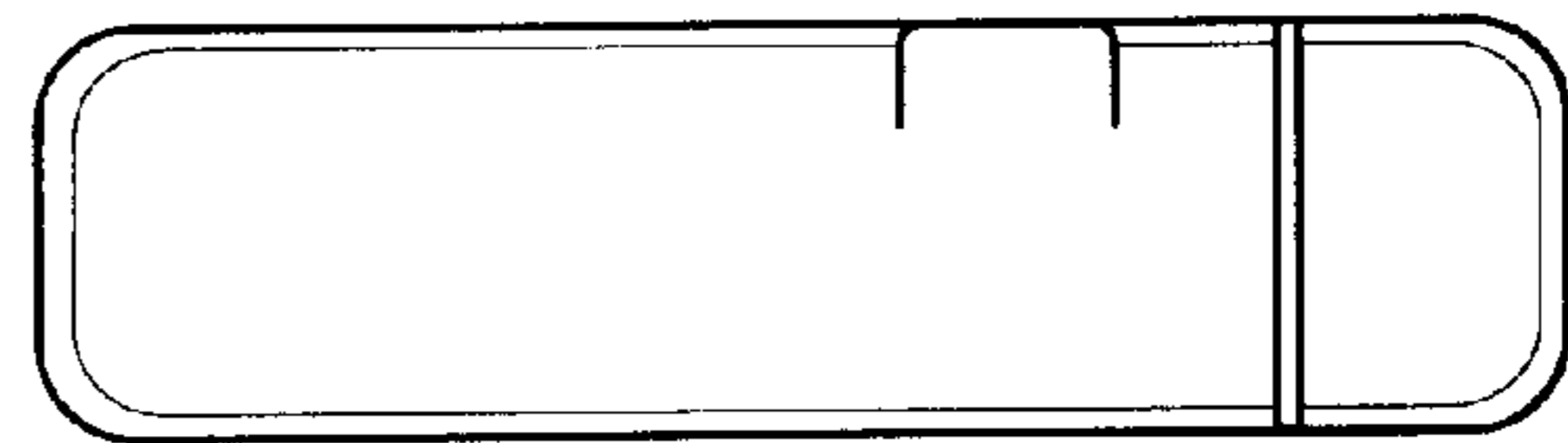

Fig. 18