



US00D558422S

(12) **United States Design Patent**
Gardner

(10) **Patent No.:** **US D558,422 S**

(45) **Date of Patent:** **** Dec. 25, 2007**

(54) **DAIRY RECYCLING BIN**

(76) **Inventor:** **Scott R. Gardner**, c/o Intercycle LLC,
92 Newark Pompton Tpke., Wayne, NJ
(US) 07470

(**) **Term:** **14 Years**

(21) **Appl. No.:** **29/276,500**

(22) **Filed:** **Jan. 26, 2007**

(51) **LOC (8) Cl.** **09-09**

(52) **U.S. Cl.** **D34/7**

(58) **Field of Classification Search** D34/1,
D34/5, 6, 7, 8, 9, 10, 11; 220/908-913, 500,
220/503

See application file for complete search history.

(56) **References Cited**

U.S. PATENT DOCUMENTS

D221,475 S *	8/1971	Norquest	D34/7
D328,168 S *	7/1992	Bartle	D34/7
D334,805 S *	4/1993	Ivey	D24/131
D340,333 S *	10/1993	Duran et al.	D34/7
D345,837 S *	4/1994	Bean	D34/5
D377,566 S *	1/1997	Norge, Jr.	D6/457

D383,277 S *	9/1997	Peters	D34/1
D540,000 S *	4/2007	Mandel	D34/7
D547,020 S *	7/2007	Chen	D34/7
D549,420 S *	8/2007	Naber	D34/9

* cited by examiner

Primary Examiner—Cynthia E. Ramirez

(74) *Attorney, Agent, or Firm*—Richard M. Goldberg

(57) **CLAIM**

The ornamental design for a dairy recycling bin, as shown and described.

DESCRIPTION

FIG. 1 is a perspective view of the dairy recycling bin of my design, viewed from the top and front;

FIG. 2 is a front elevational view thereof;

FIG. 3 is a rear elevational view thereof;

FIG. 4 is a left side elevational view thereof;

FIG. 5 is a right side elevational view thereof;

FIG. 6 is a top plan view thereof; and,

FIG. 7 is a bottom plan view thereof.

1 Claim, 7 Drawing Sheets

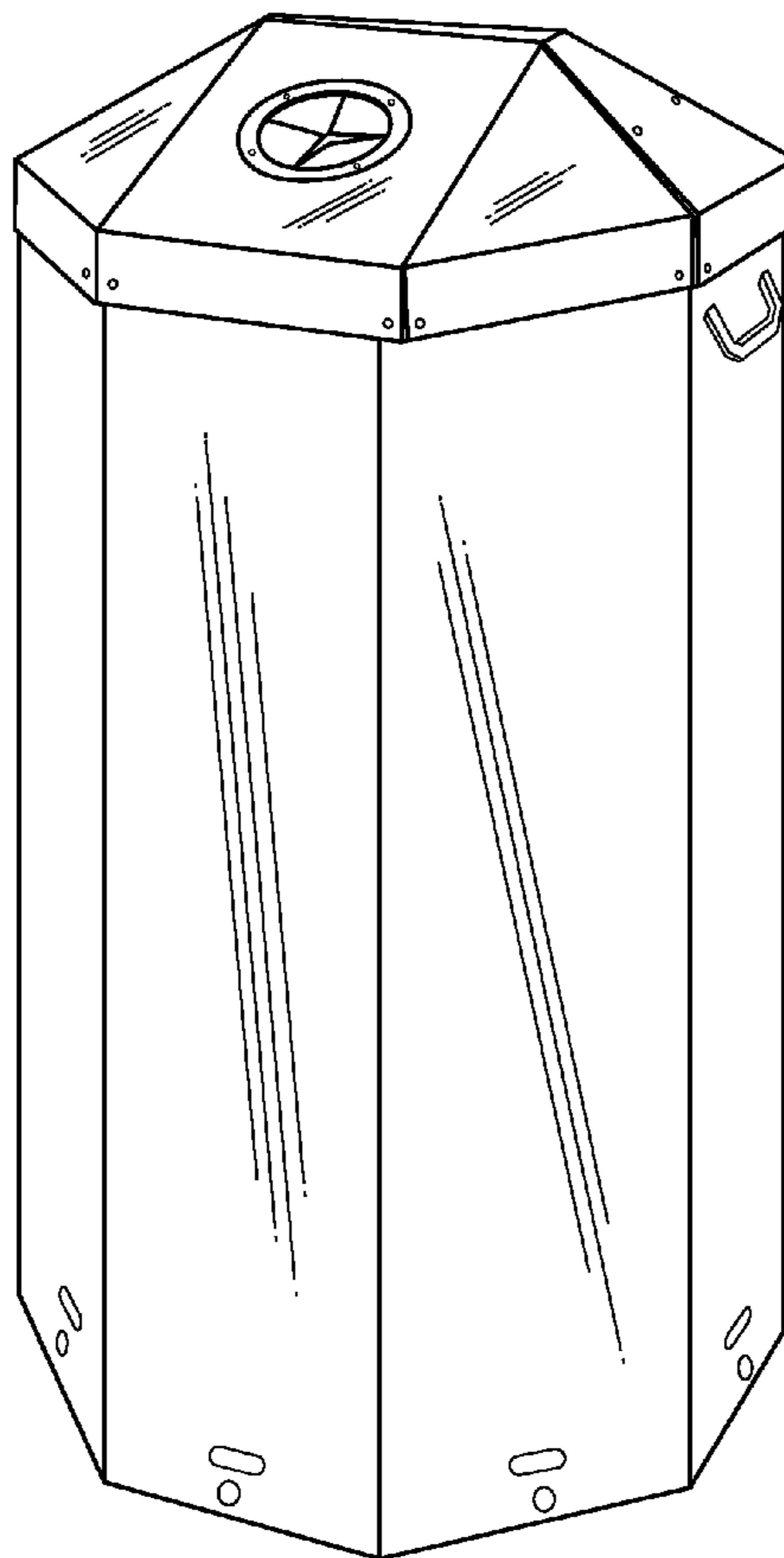

FIG. 1

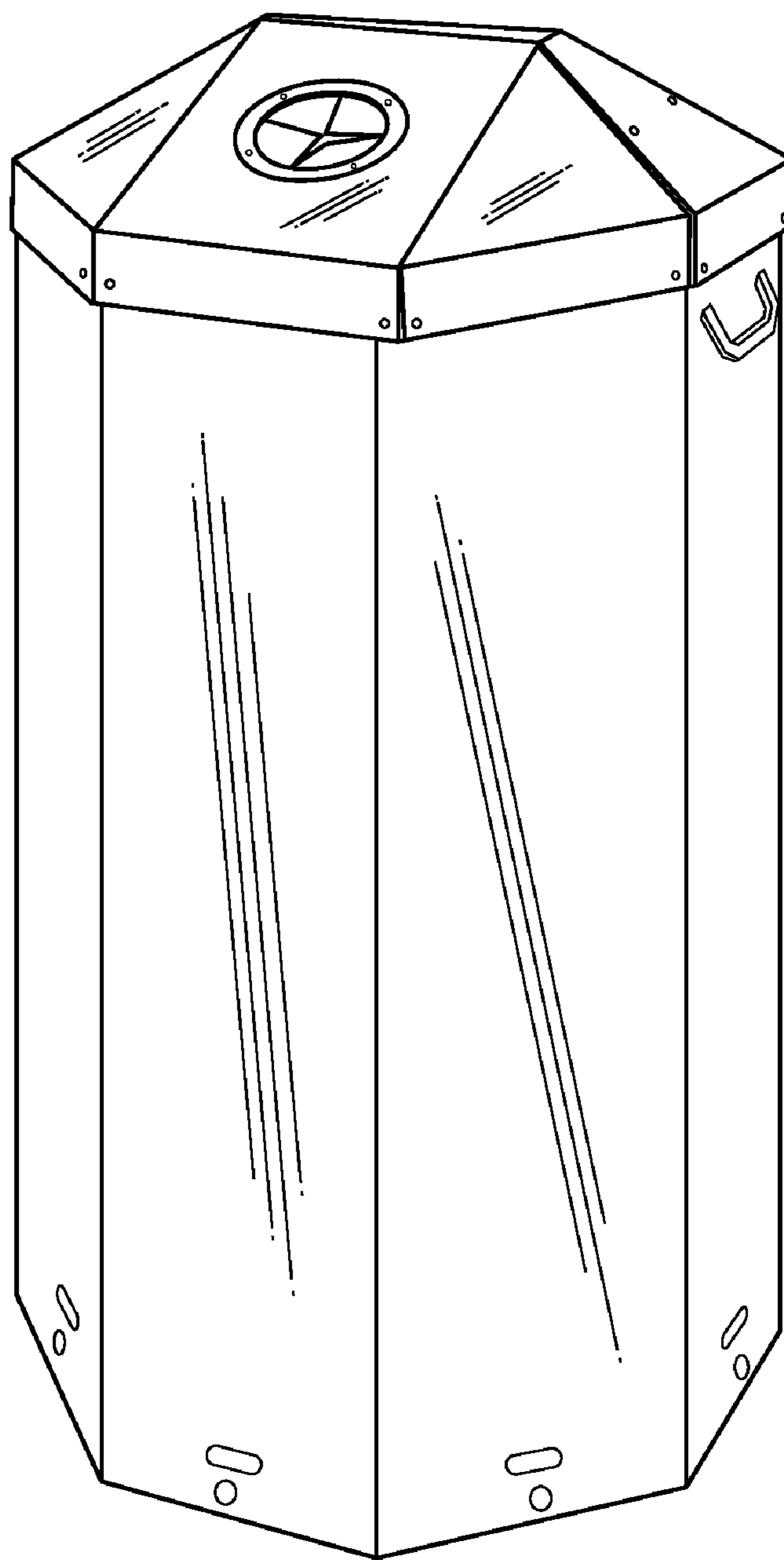

FIG. 2

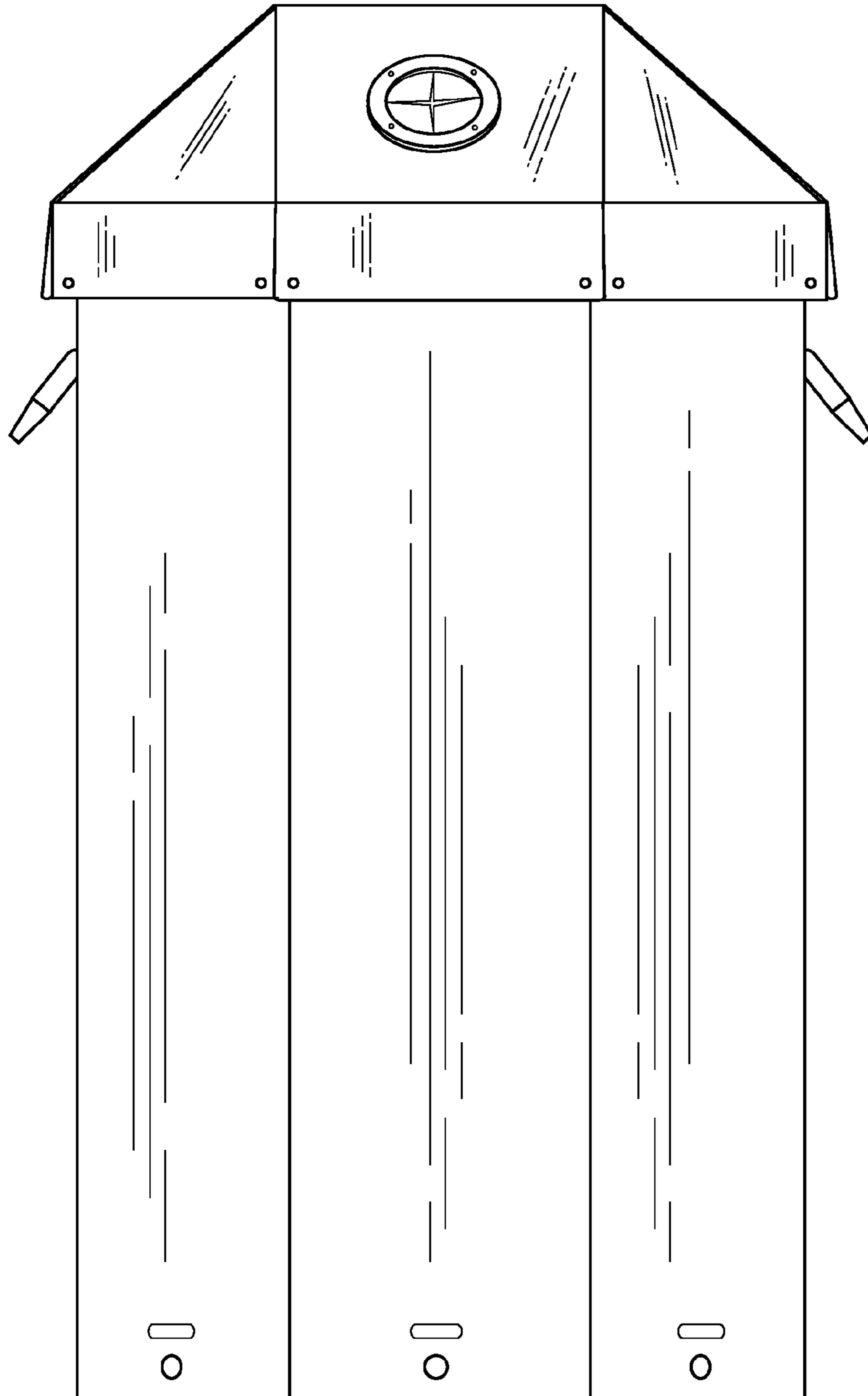

FIG. 3

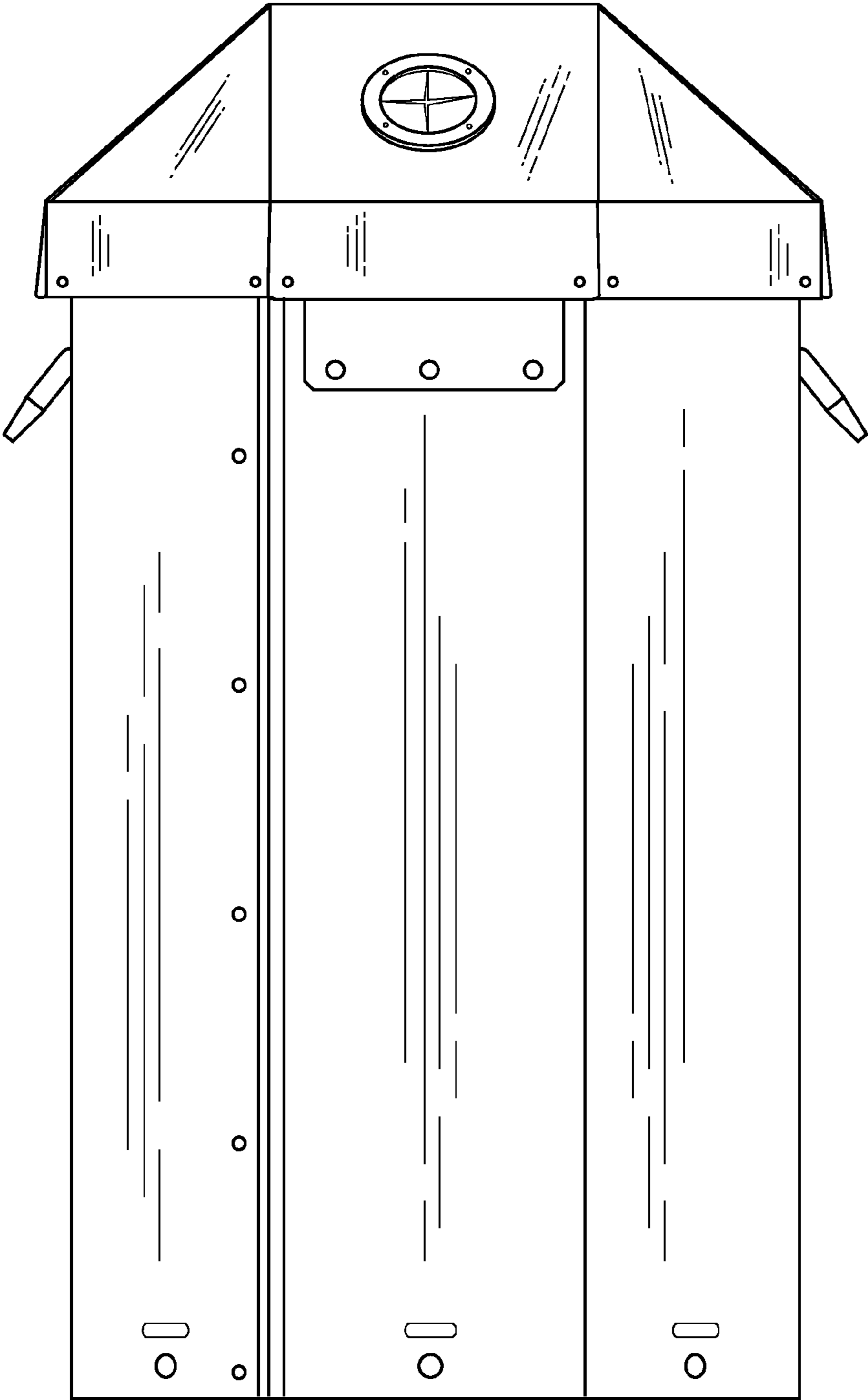

FIG. 4

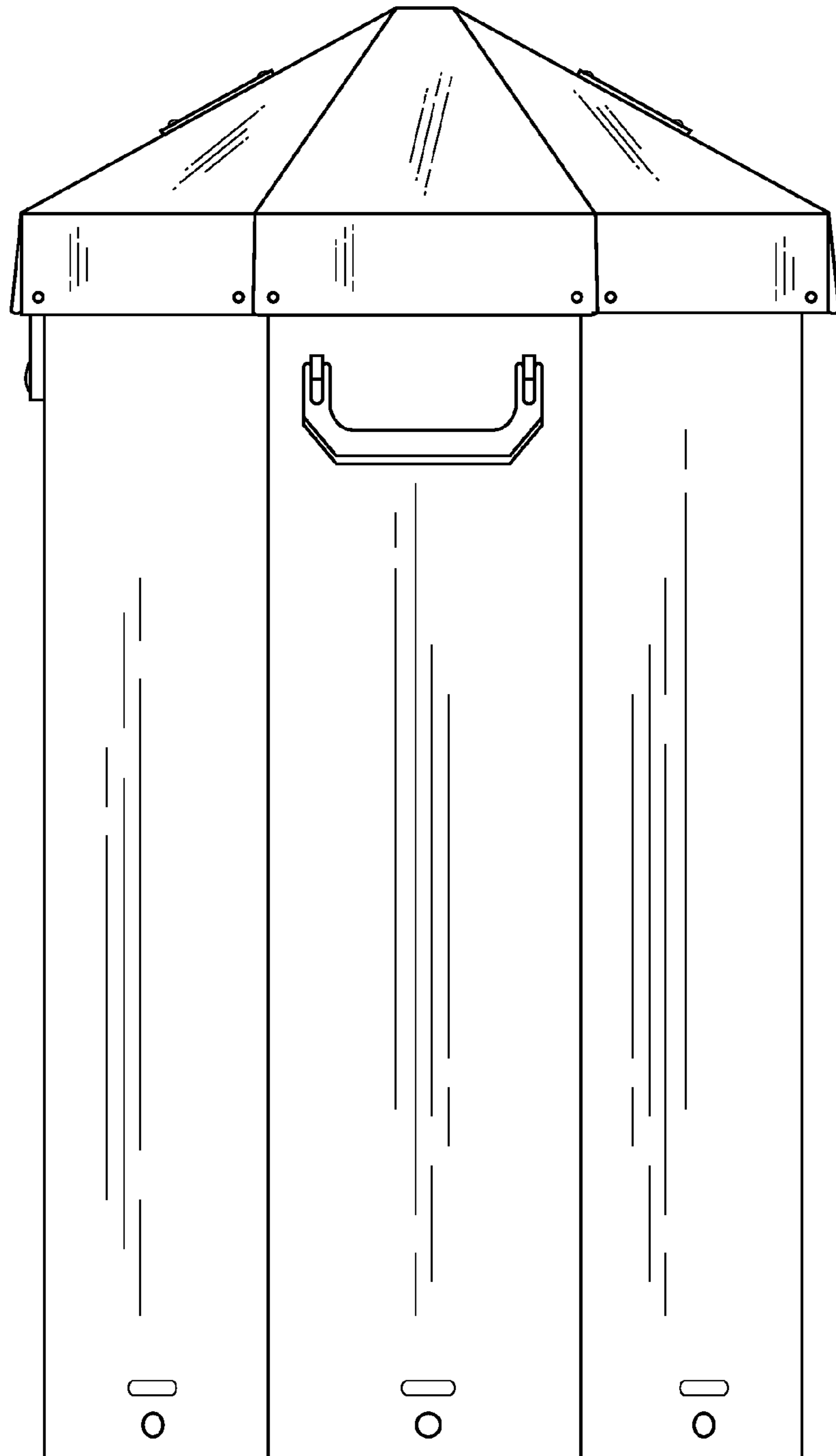

FIG. 5

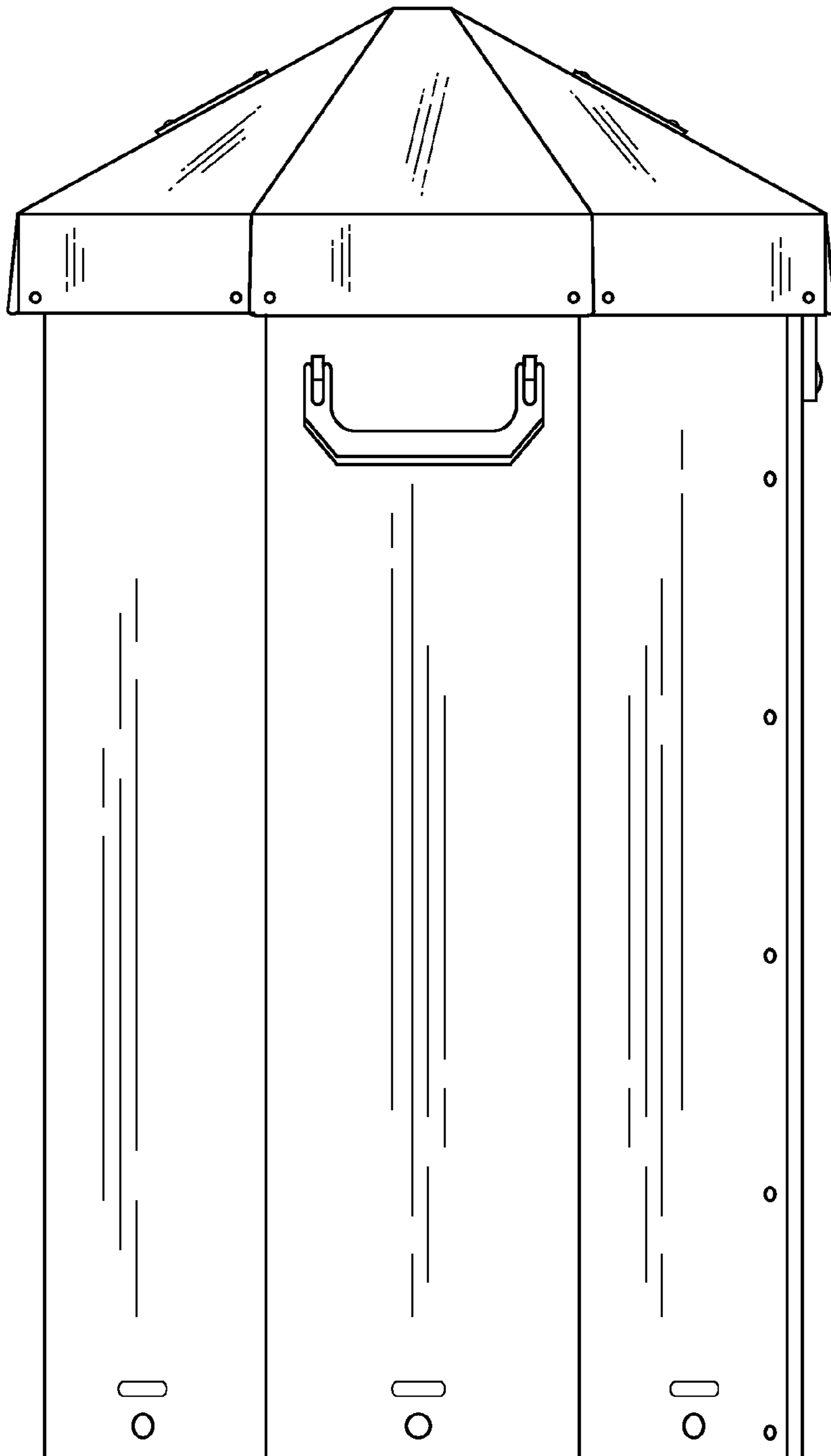

FIG. 6

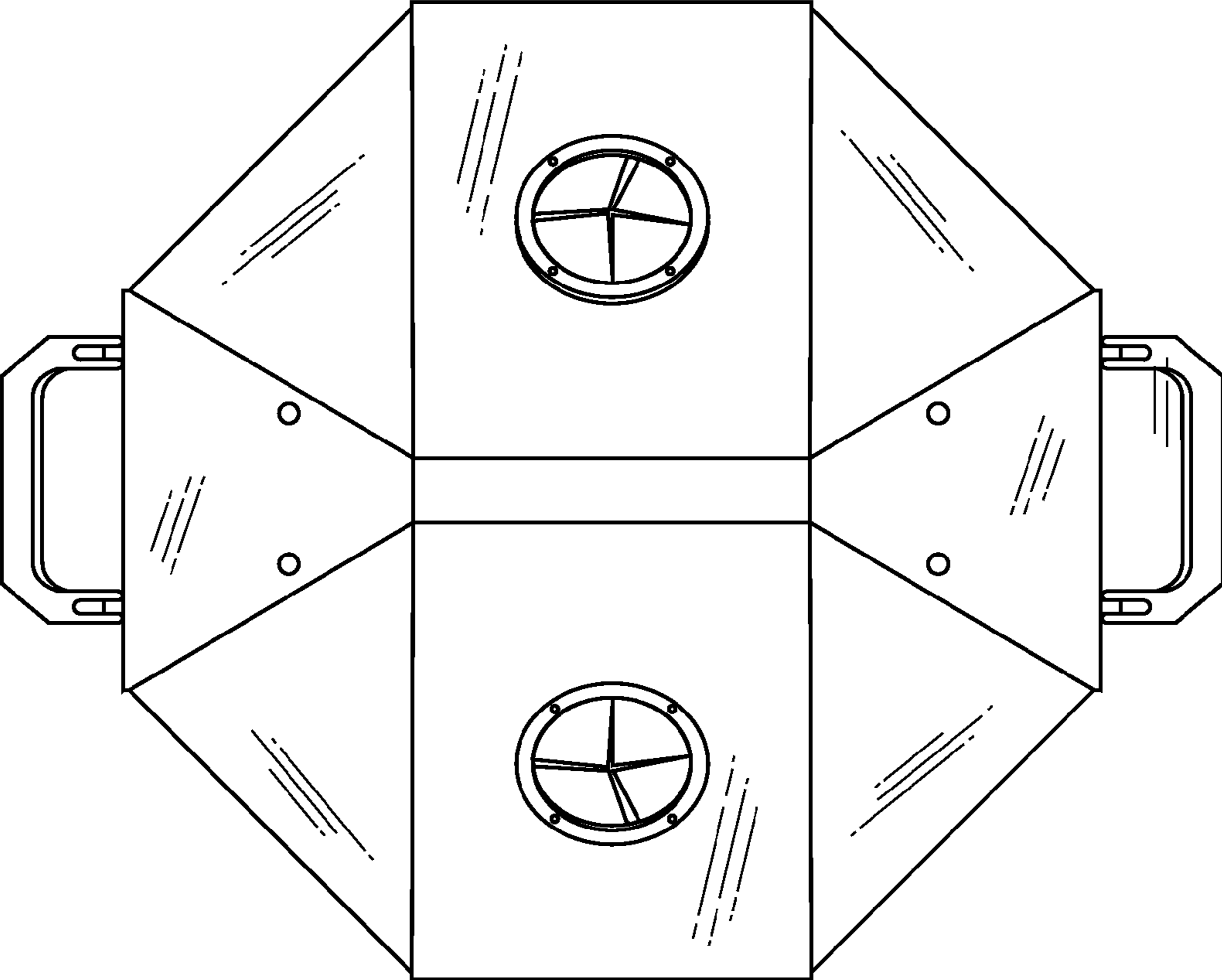

FIG. 7

