



US00D558411S

(12) **United States Design Patent** (10) **Patent No.:** **US D558,411 S**  
**Joo** (45) **Date of Patent:** **\*\* Dec. 25, 2007**

(54) **UPRIGHT VACUUM CLEANER**

(76) **Inventor:** **Young-Jong Joo**, 532-1 Cheon-Ri,  
Idong-Myeon, Yongin Si, Gyeonggi-Do  
(KR) 449-833

(\*\*) **Term:** **14 Years**

(21) **Appl. No.:** **29/267,828**

(22) **Filed:** **Oct. 23, 2006**

(51) **LOC (8) Cl.** ..... **15-05**

(52) **U.S. Cl.** ..... **D32/22**

(58) **Field of Classification Search** ..... D32/21-22,  
D32/31, 34; 15/328-329, 320-321, 323,  
15/257.01, 347, 350-353, 361, 363, 366,  
15/410-412, 414, 415.1, 335, 327.1  
See application file for complete search history.

(56) **References Cited**

**U.S. PATENT DOCUMENTS**

D301,649 S *	6/1989	Yamamoto et al.	.....	D32/22
D303,171 S *	8/1989	Goodrich et al.	.....	D32/22
D307,656 S *	5/1990	Yuen	.....	D32/22
D307,657 S *	5/1990	Li	.....	D32/22
D399,618 S *	10/1998	Jacobs	.....	D32/22

D483,160 S *	12/2003	Houghton	.....	D32/22
D518,928 S *	4/2006	Chiba	.....	D32/22
2004/0006842 A1 *	1/2004	Lee et al.	.....	15/351
2006/0000050 A1 *	1/2006	Cipolla et al.	.....	15/353

\* cited by examiner

*Primary Examiner*—Ruth McInroy  
(74) *Attorney, Agent, or Firm*—GWiPS

(57) **CLAIM**

I claim the ornamental design for an upright vacuum cleaner,  
as shown and described.

**DESCRIPTION**

FIG. 1 is a perspective view showing my new design for an upright vacuum cleaner.

FIG. 2 is a front view thereof.

FIG. 3 is a rear view thereof.

FIG. 4 is a left side view thereof.

FIG. 5 is a right side view thereof.

FIG. 6 is a top plan view thereof; and,

FIG. 7 is a bottom plan view thereof.

**1 Claim, 6 Drawing Sheets**

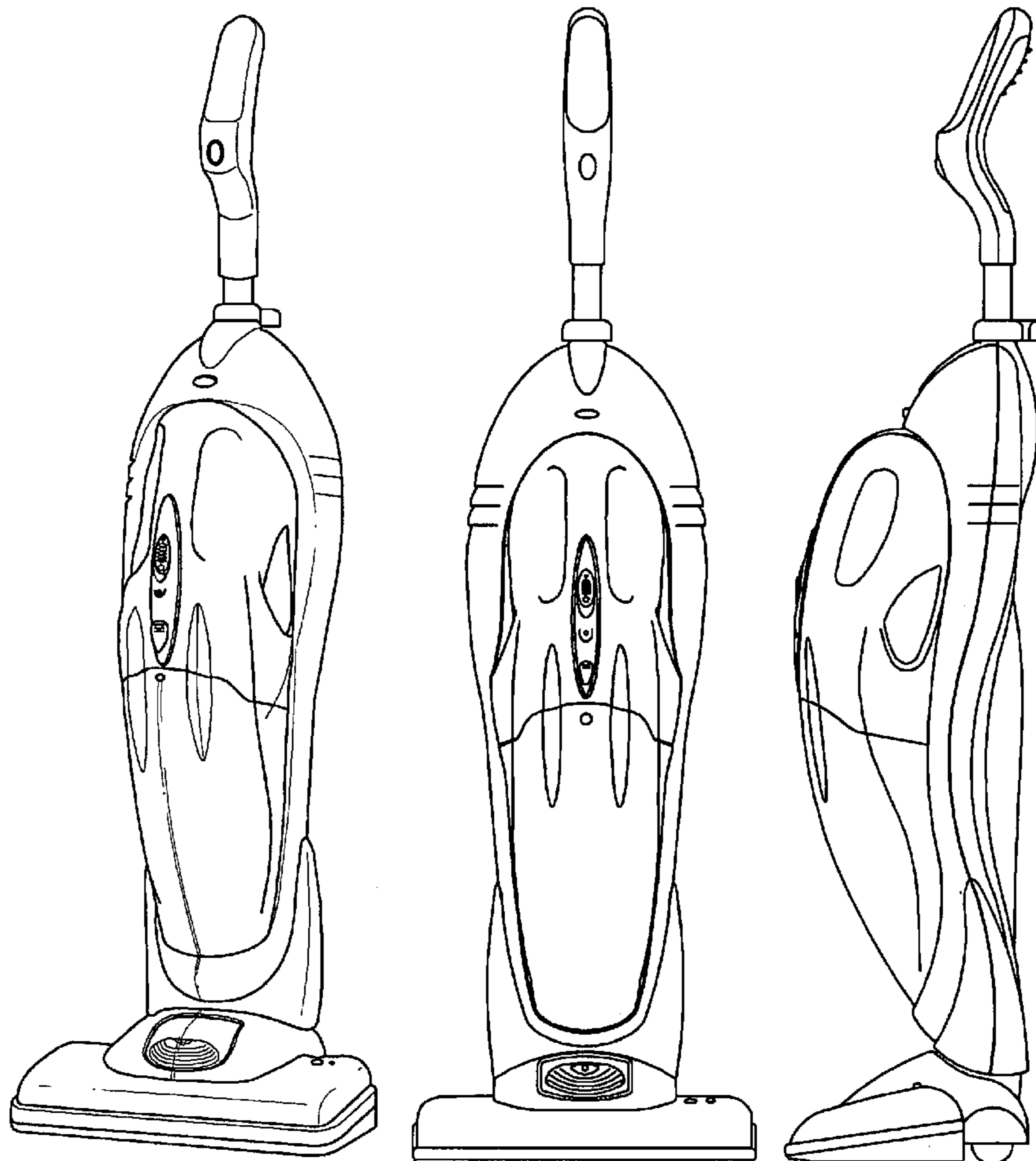

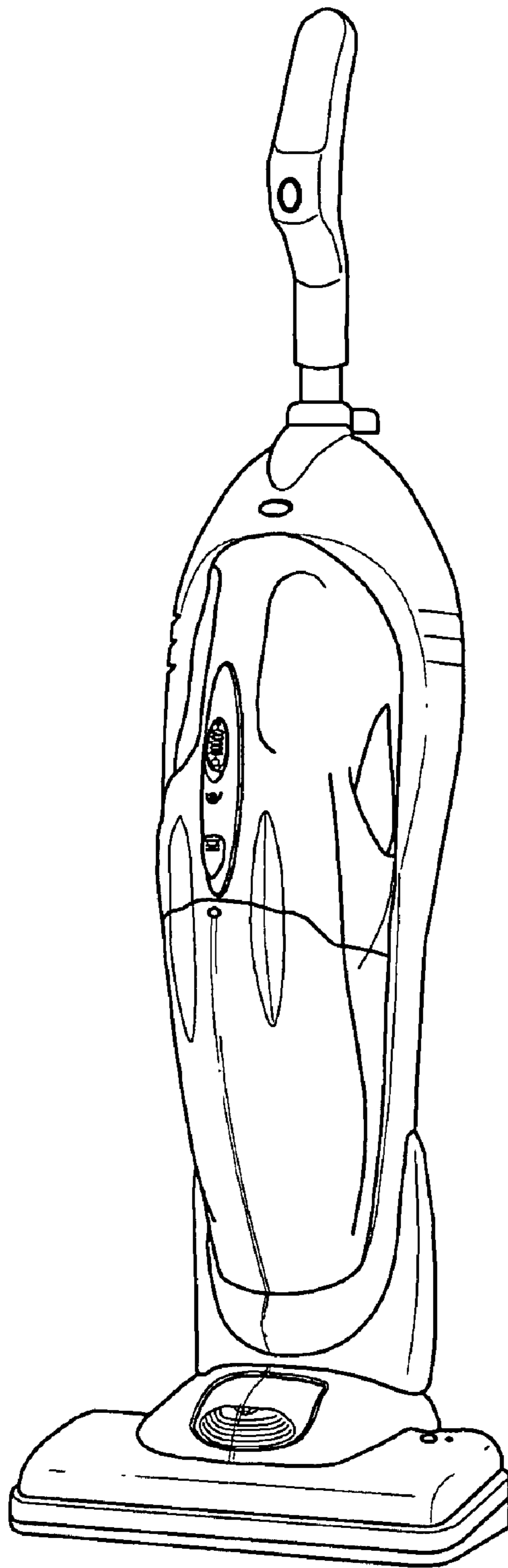

Fig. 1

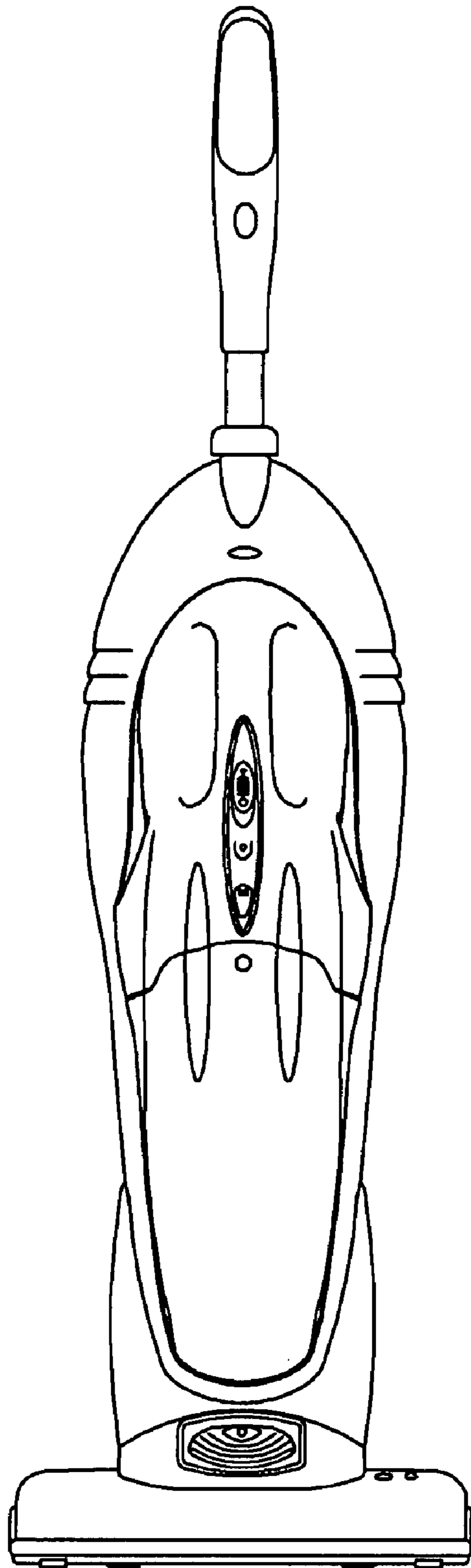

Fig. 2

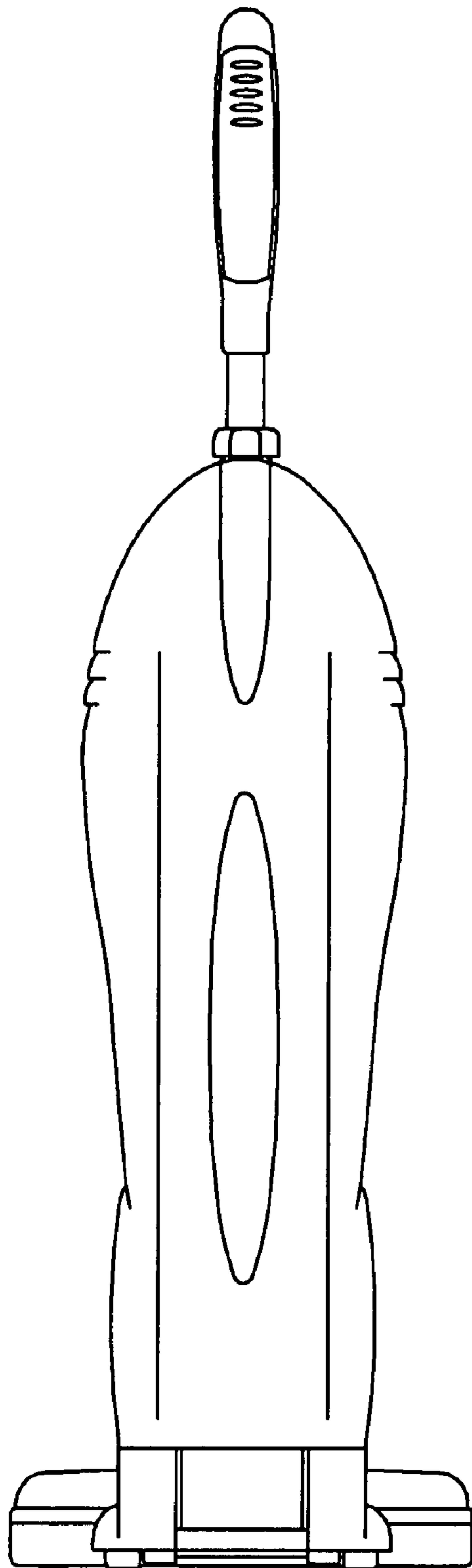

Fig. 3

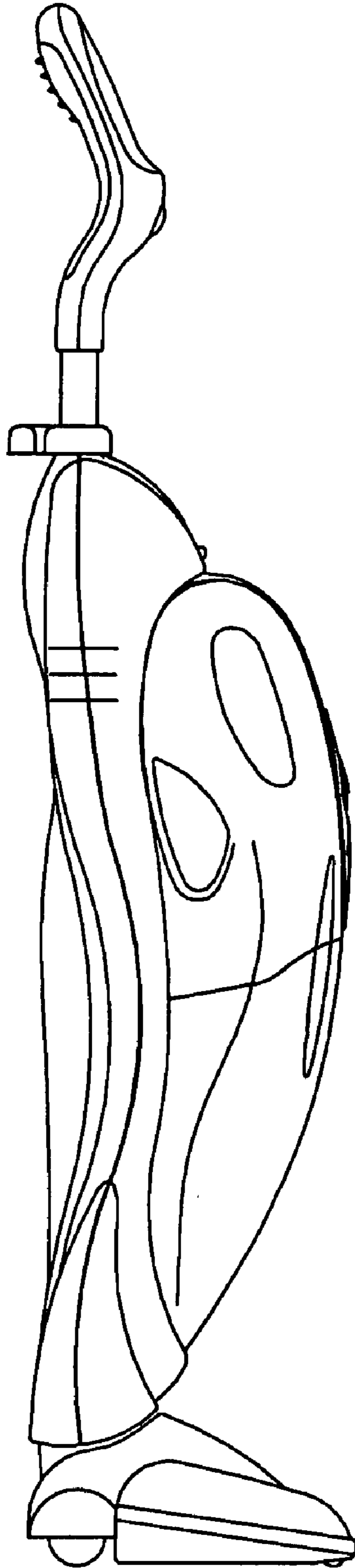

Fig. 4

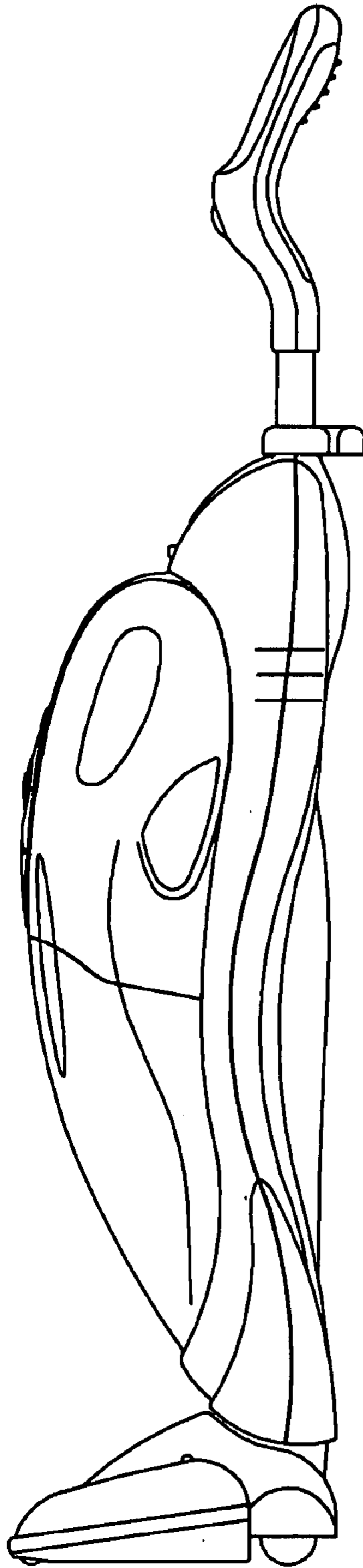
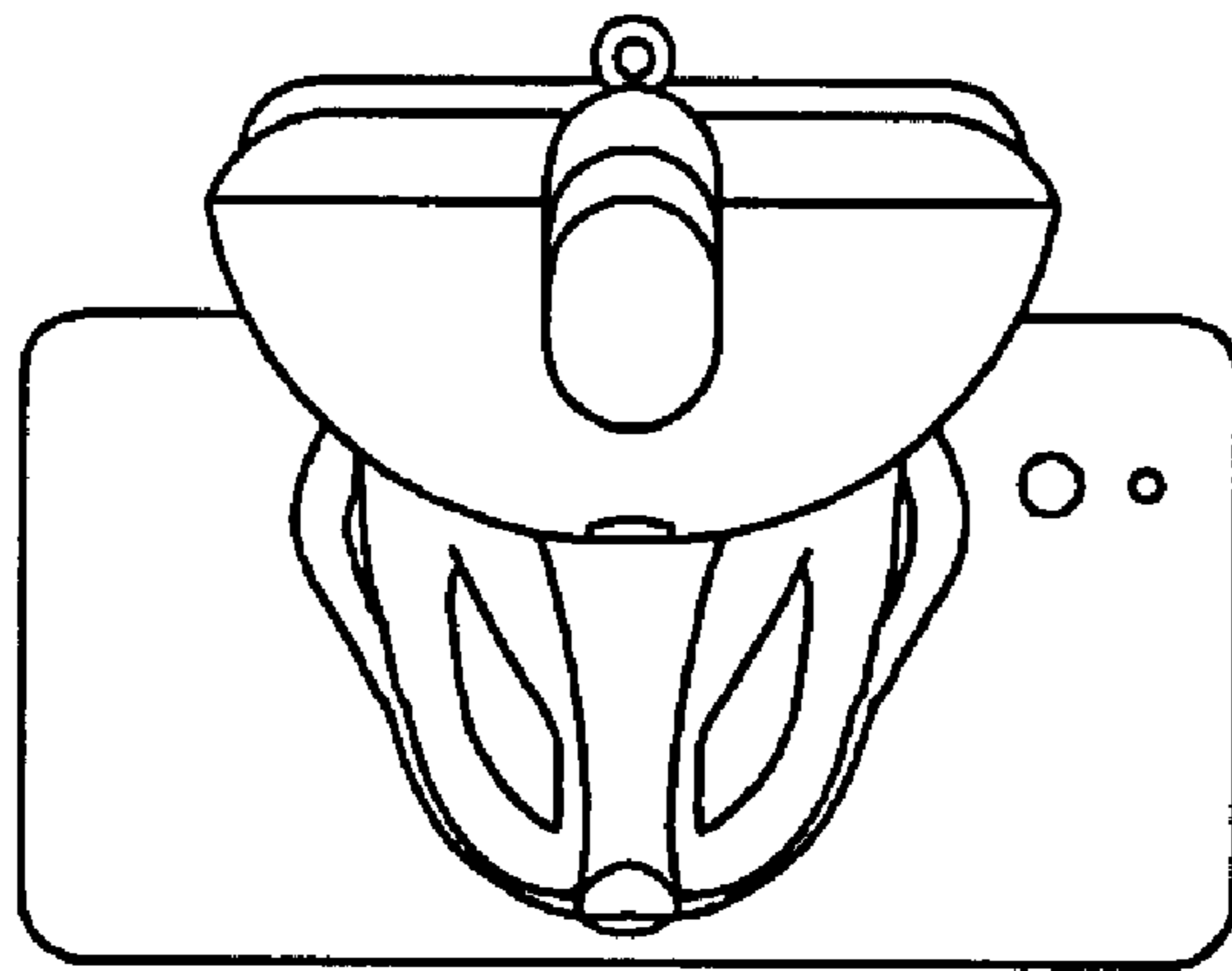
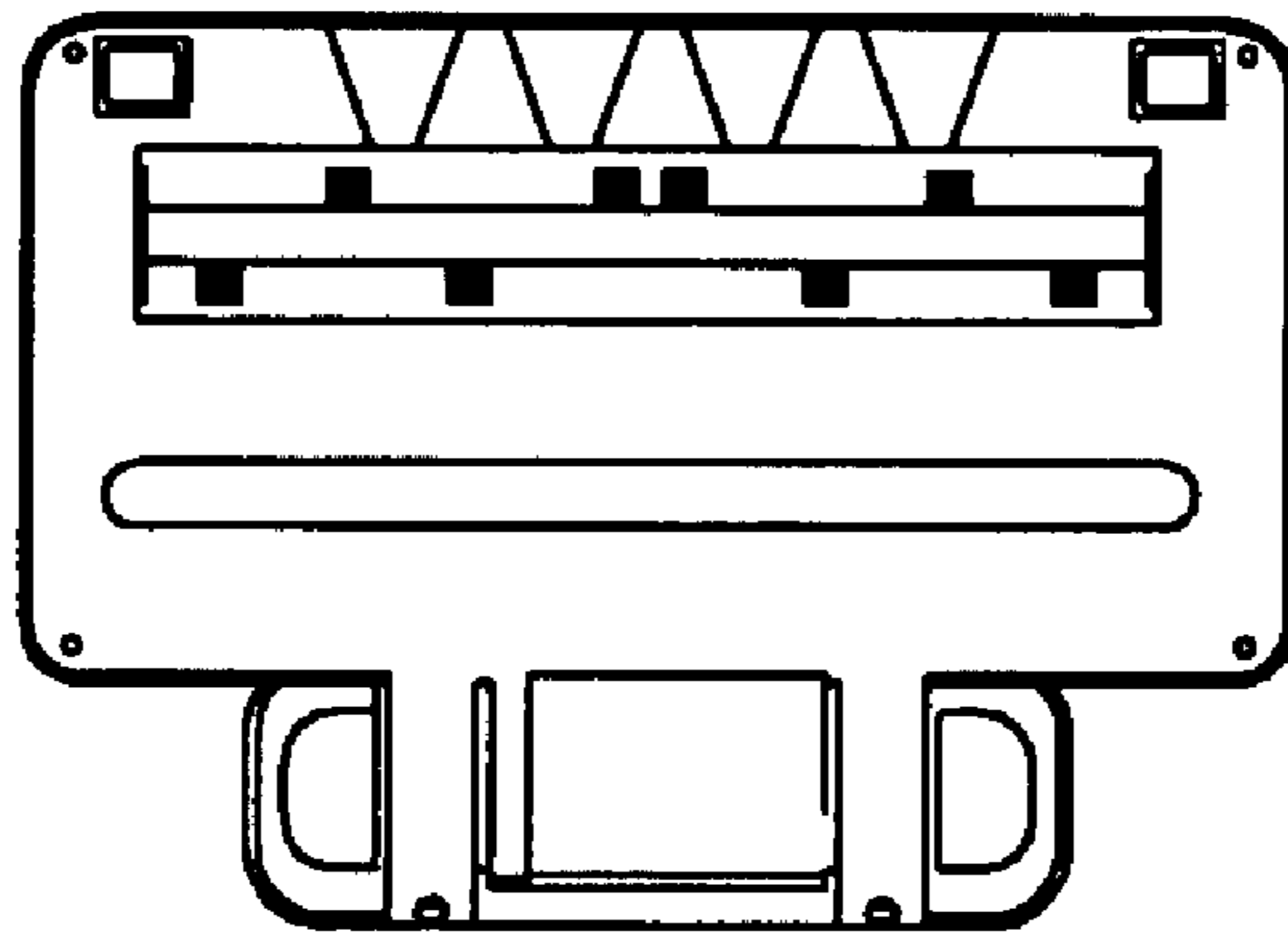

Fig. 5



**Fig. 6**



**Fig. 7**