



US00D558391S

(12) **United States Design Patent**
Lin

(10) **Patent No.:** **US D558,391 S**

(45) **Date of Patent:** **** Dec. 25, 2007**

(54) **BULLET SHELL LIGHTER**

D231,012 S * 3/1974 Paroty D27/157
D459,541 S * 6/2002 Richmond D27/148

(76) Inventor: **Rong Lin**, 2916 Arabian Pl. NE.,
Marietta, GA (US) 30062

* cited by examiner

(**) Term: **14 Years**

Primary Examiner—Jennifer Rivard

(21) Appl. No.: **29/267,223**

(57) **CLAIM**

(22) Filed: **Oct. 10, 2006**

The ornamental design for a bullet shell lighter, as shown.

(51) **LOC (8) Cl.** **27-05**

(52) **U.S. Cl.** **D27/148**

(58) **Field of Classification Search** D27/141,
D27/142, 148-161; D22/112, 116; 431/125,
431/253

See application file for complete search history.

DESCRIPTION

FIG. 1 is a front elevational view thereof;
FIG. 2 is a left side elevational view thereof;
FIG. 3 is a right side elevational view thereof;
FIG. 4 is a top plan view thereof;
FIG. 5 is a bottom plan view thereof.
FIG. 6 is a front elevational view of open position thereof;
and,
FIG. 7 is a top plan view of open position thereof.

(56) **References Cited**

U.S. PATENT DOCUMENTS

D51,974 S * 4/1918 Sherman D22/116
D92,581 S * 6/1934 Chesler D27/152
D205,712 S * 9/1966 Sylvester et al. D22/112
D225,891 S * 1/1973 Strzelczyk D27/157

1 Claim, 7 Drawing Sheets

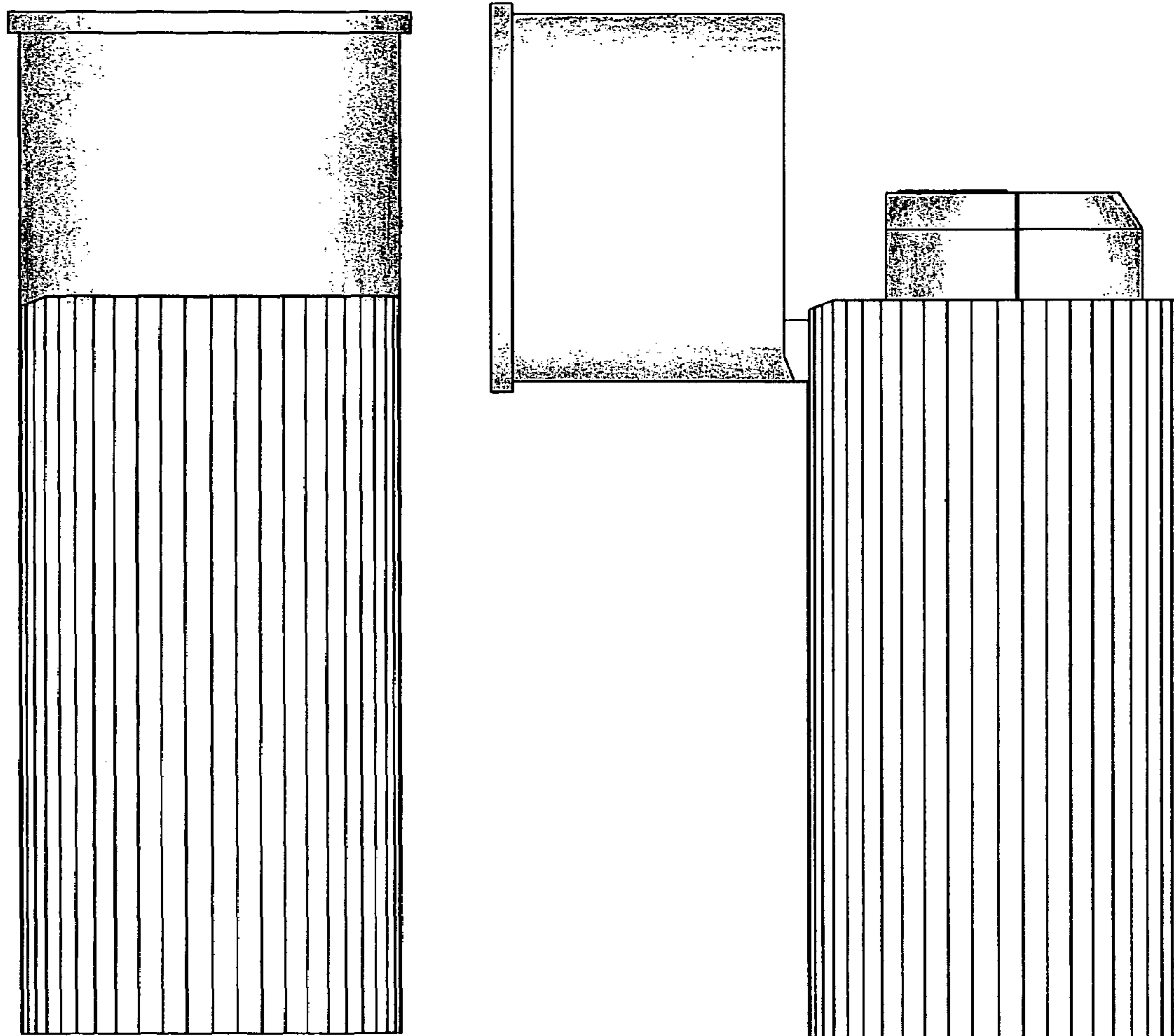

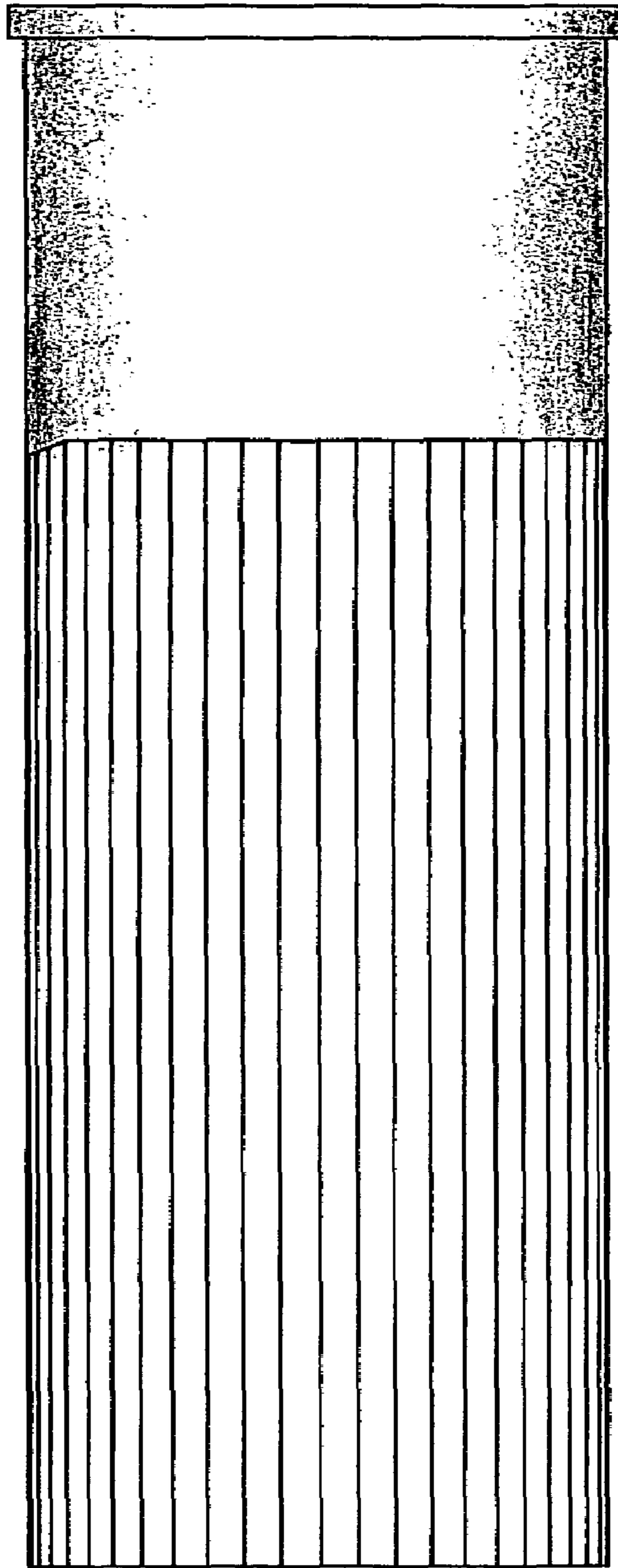

FIG. 1

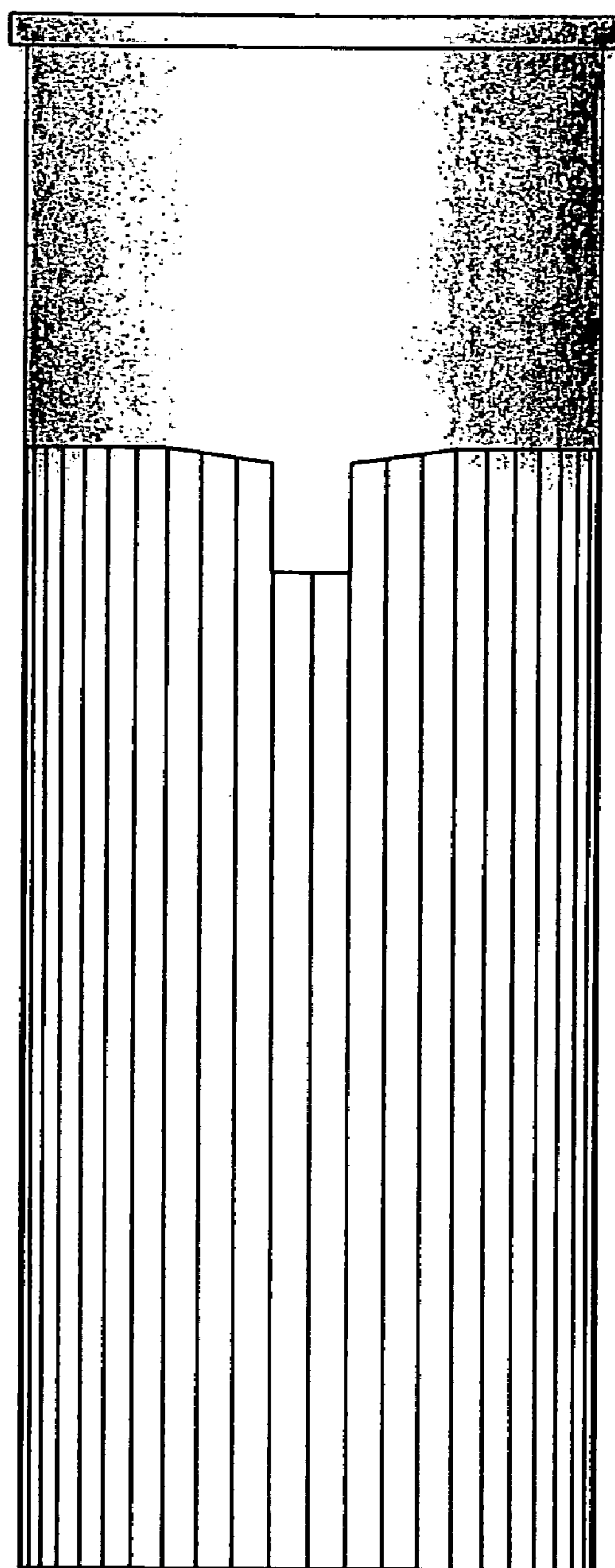

FIG. 2

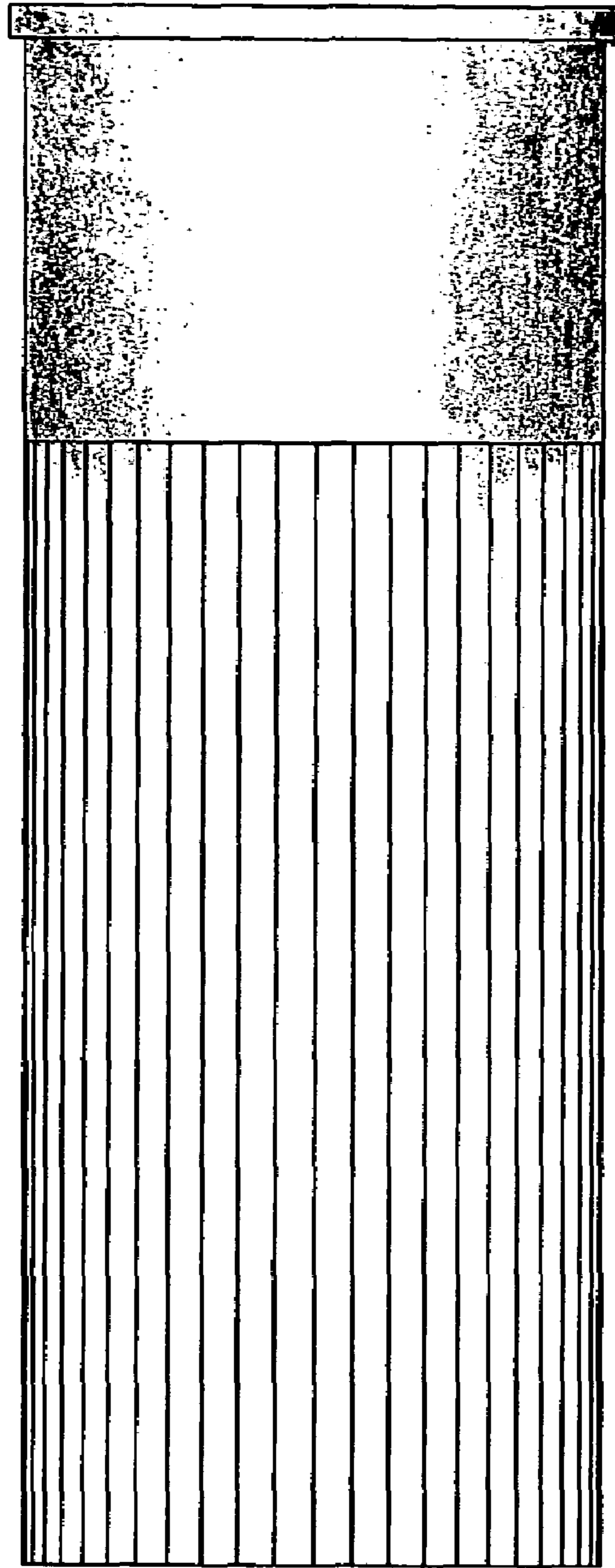

FIG. 3

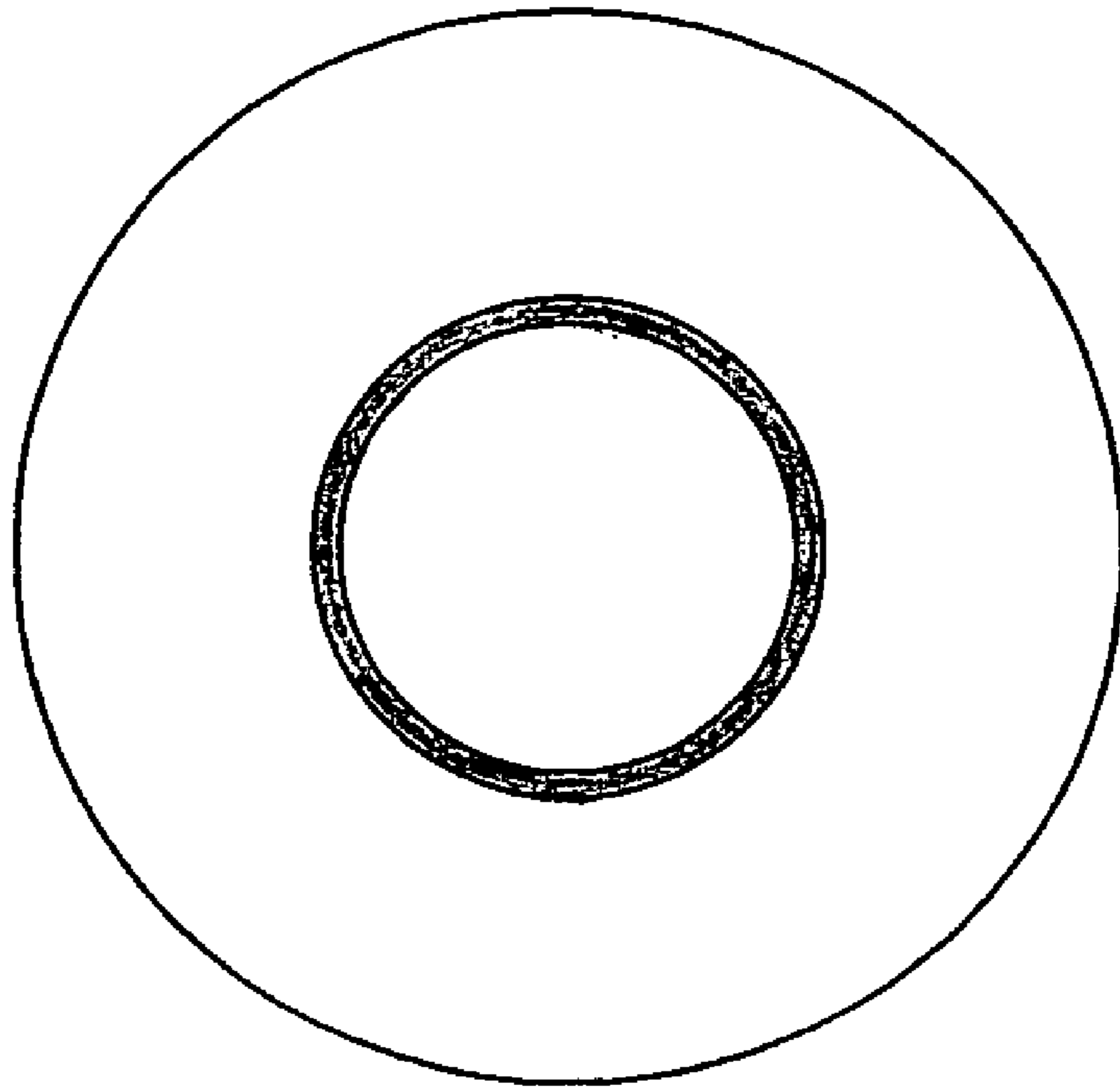

FIG. 4

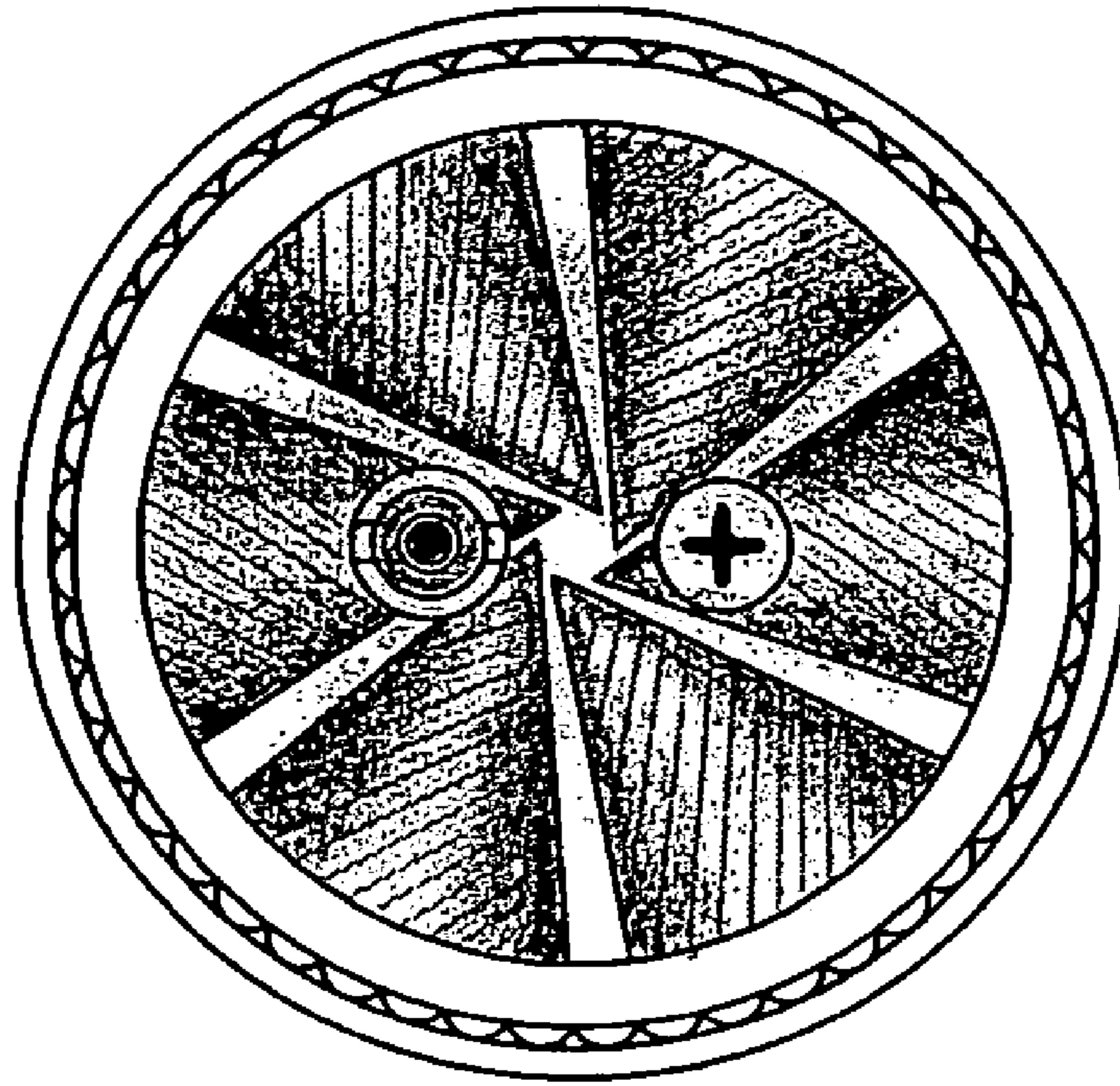

FIG. 5

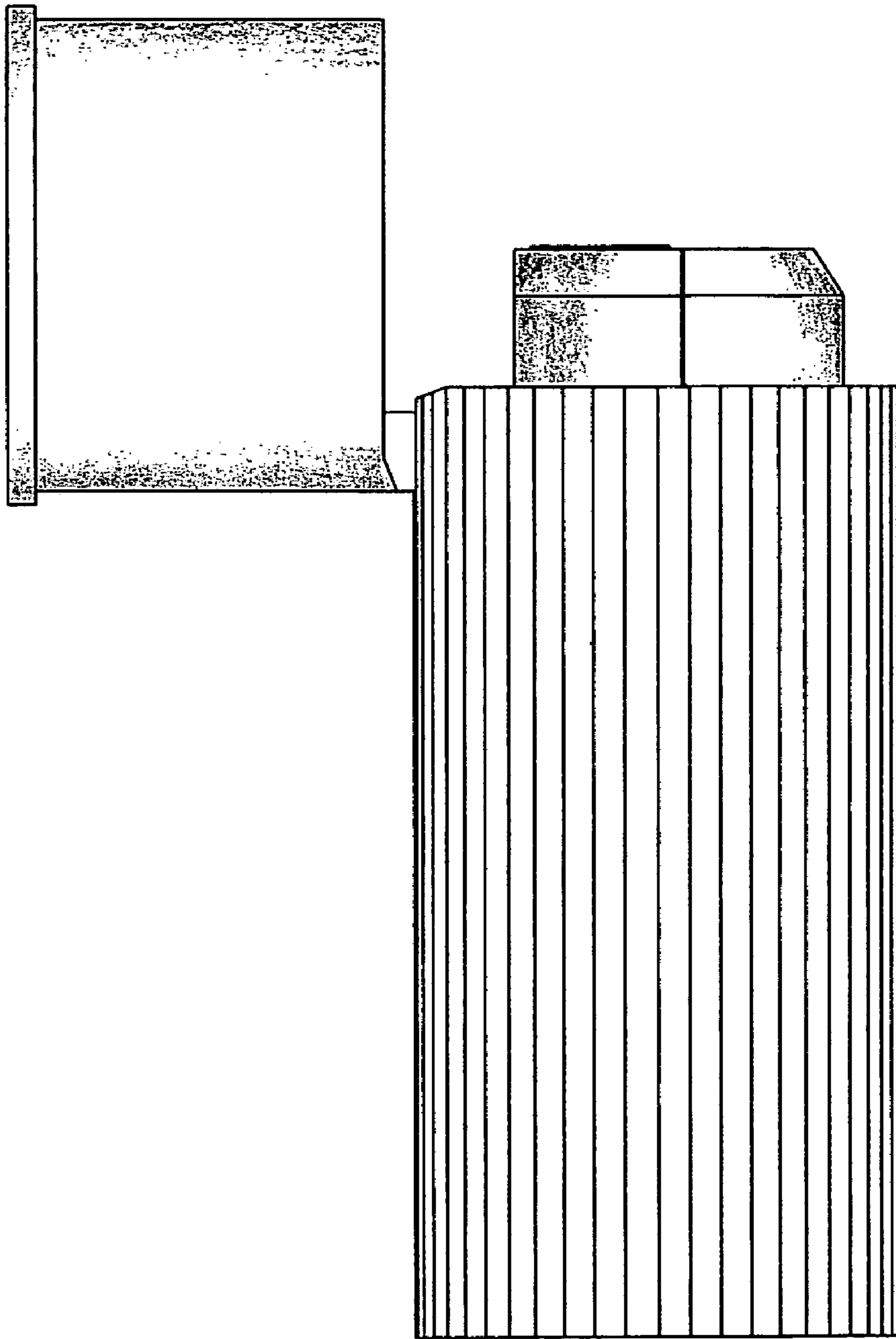

FIG. 6

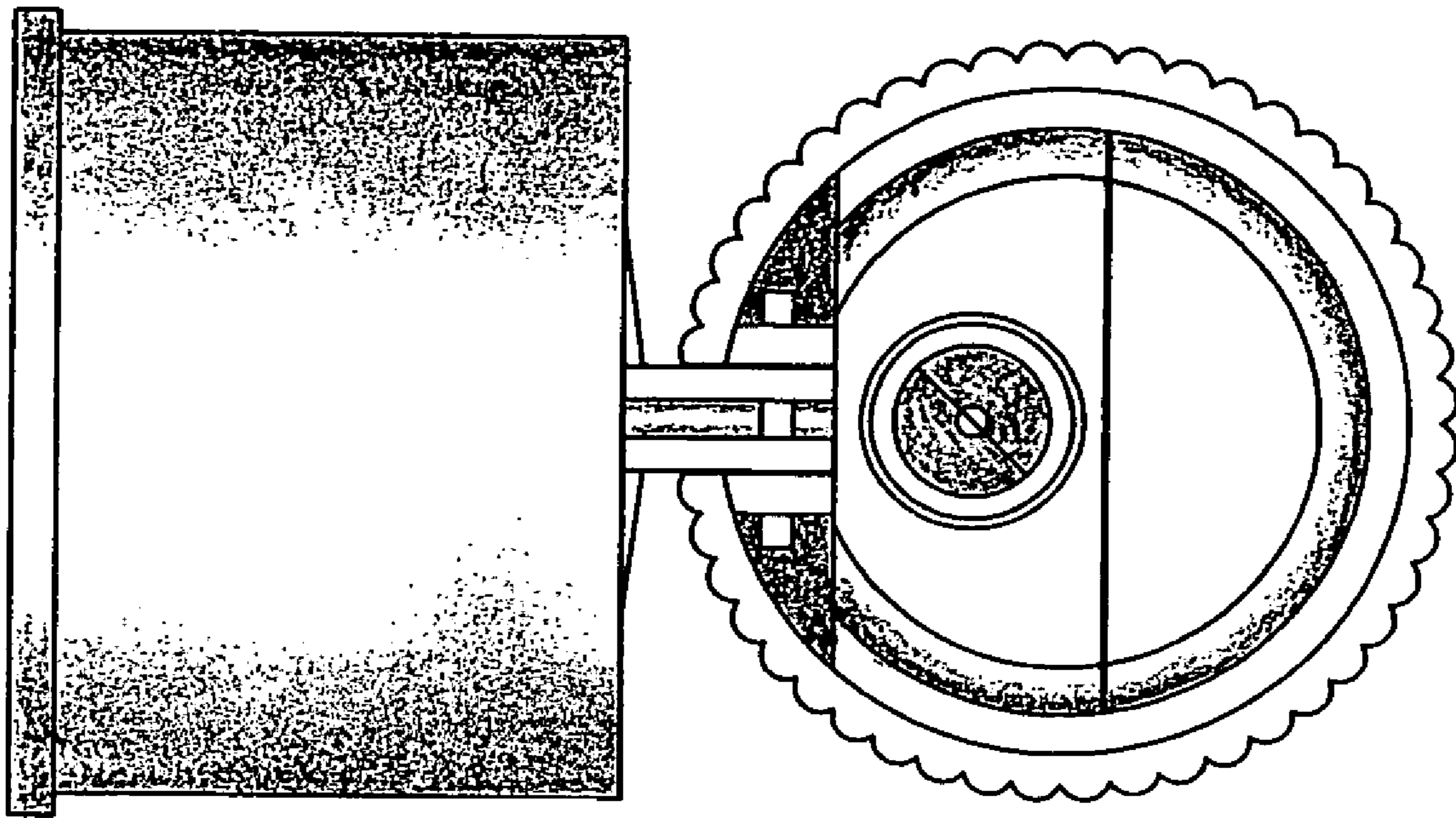

FIG. 7