



US00D558388S

(12) **United States Design Patent**
Ward

(10) **Patent No.:** **US D558,388 S**

(45) **Date of Patent:** **** Dec. 25, 2007**

(54) **CEILING LIGHT FIXTURE**

(76) Inventor: **Patrick H. Ward**, 410 Live Oak St.,
San Antonio, TX (US) 78202

(**) Term: **14 Years**

(21) Appl. No.: **29/226,598**

(22) Filed: **Mar. 30, 2005**

(51) **LOC (8) Cl.** **26-99**

(52) **U.S. Cl.** **D26/138**

(58) **Field of Classification Search** D26/119,
D26/118, 74, 72, 75, 120, 131, 138, 152,
D26/67, 42, 46, 81, 83, 113, 123, 124, 128,
D26/137, 115; 362/147, 362, 404-408, 364,
362/365, 296, 346, 366, 275, 257, 260, 433,
362/434

See application file for complete search history.

(56) **References Cited**

U.S. PATENT DOCUMENTS

1,987,705	A *	1/1935	Pedersen	362/364
2,929,920	A *	3/1960	Feig	362/310
2,997,575	A *	8/1961	Schwartz	362/364
D243,875	S *	3/1977	Schwartz	D26/87
4,985,815	A *	1/1991	Endo	362/294
D316,911	S *	5/1991	Hazerjian et al.	D26/67
D323,037	S *	1/1992	Edwards	D26/118
5,465,199	A *	11/1995	Bray et al.	362/364

D383,564	S *	9/1997	Lecluze	D26/118
D397,472	S *	8/1998	Lecluze	D26/118
D399,590	S *	10/1998	Lecluze	D26/118
D417,306	S *	11/1999	Pahl	D26/118
D417,307	S *	11/1999	Pahl	D26/118
D439,008	S *	3/2001	Kim, II	D26/118
D473,965	S *	4/2003	Lecluze	D26/74
D473,966	S *	4/2003	Lecluze	D26/74
D474,300	S *	5/2003	Lecluze	D26/74

* cited by examiner

Primary Examiner—Freda S. Nunn

Assistant Examiner—Kevin K Rudzinski

(57) **CLAIM**

I claim the ornamental design for the ceiling light fixture, as shown and described.

DESCRIPTION

FIG. 1 is a side elevational view of the visible portion;
FIG. 2 is a bottom plan view looking directly into the fixture;
FIG. 3 is a front bottom perspective view;
FIG. 4 is a rear bottom perspective view; and,
FIG. 5 is a left bottom perspective view.

The broken lines are included for the purpose of illustrating environmental structures and form no part of the claimed design.

1 Claim, 3 Drawing Sheets

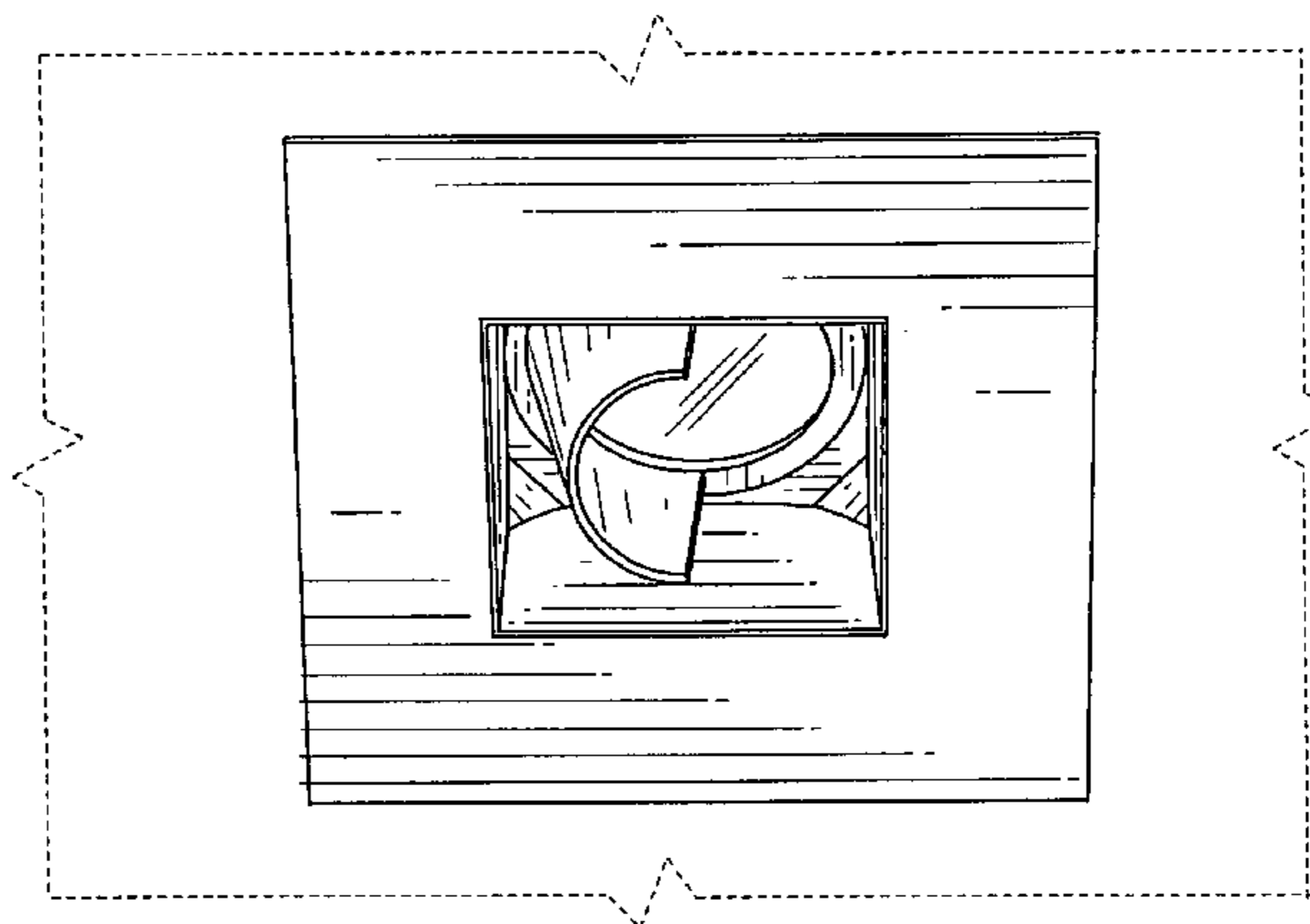
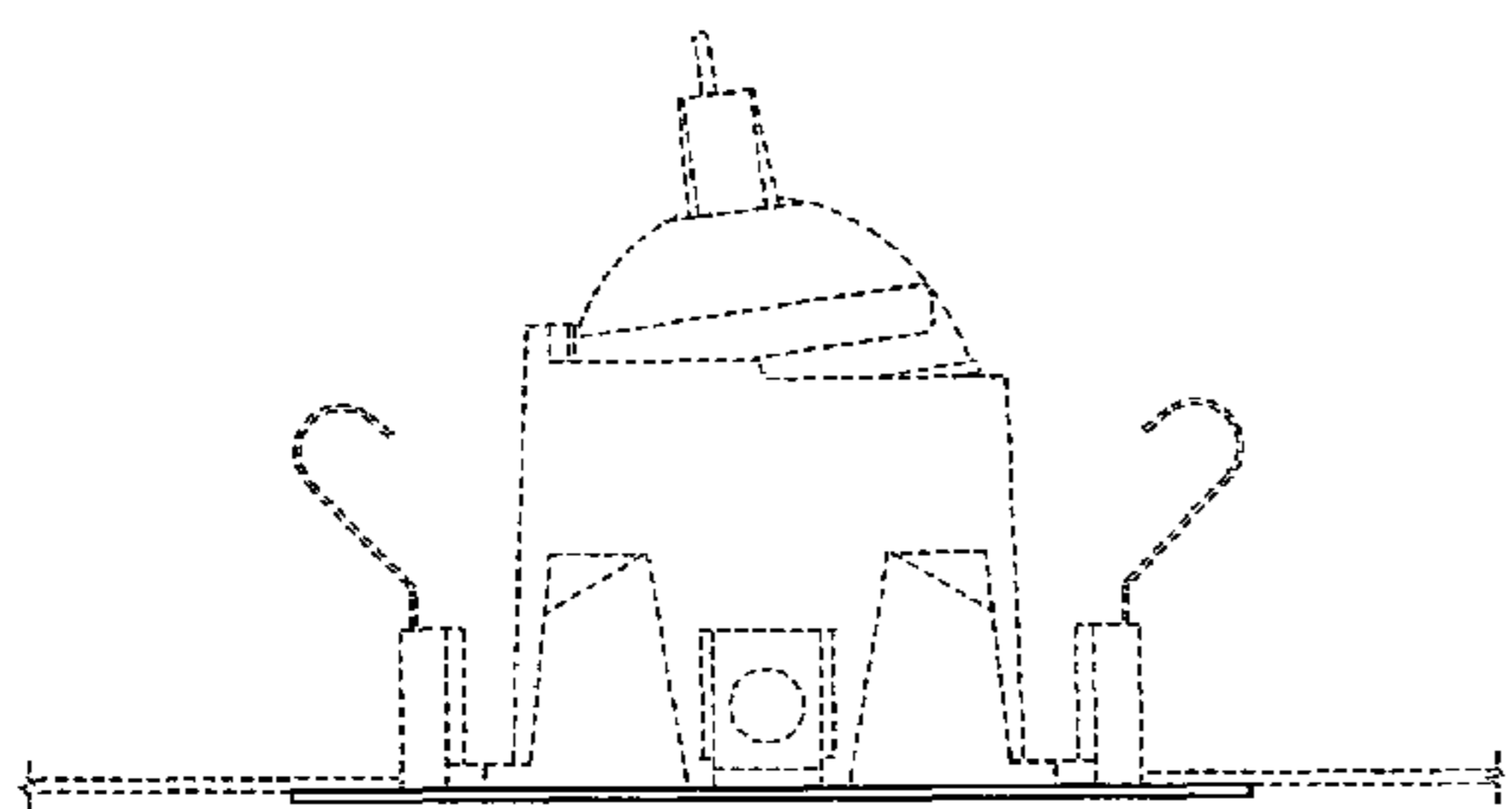

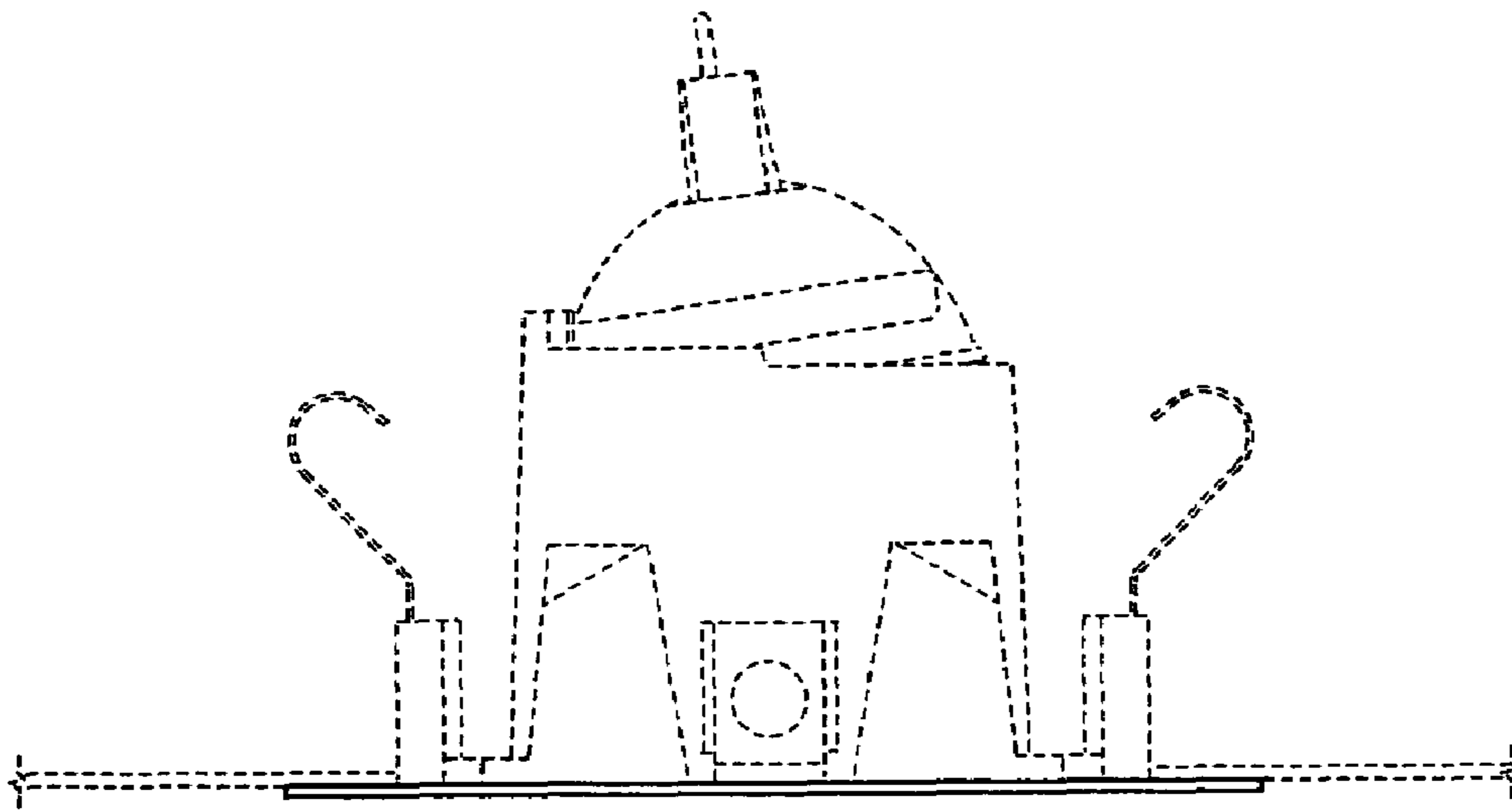

Fig. 1

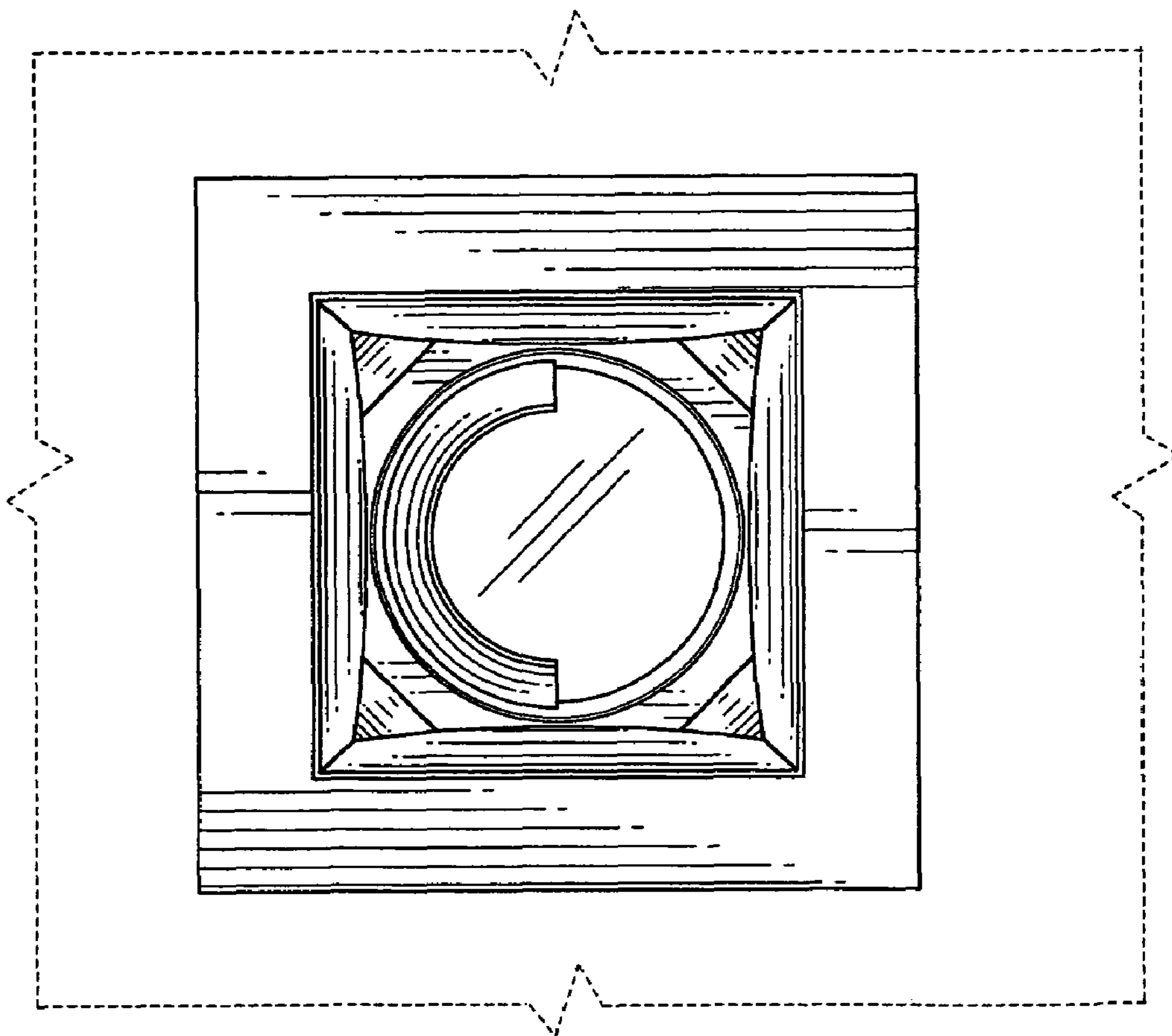

Fig. 2

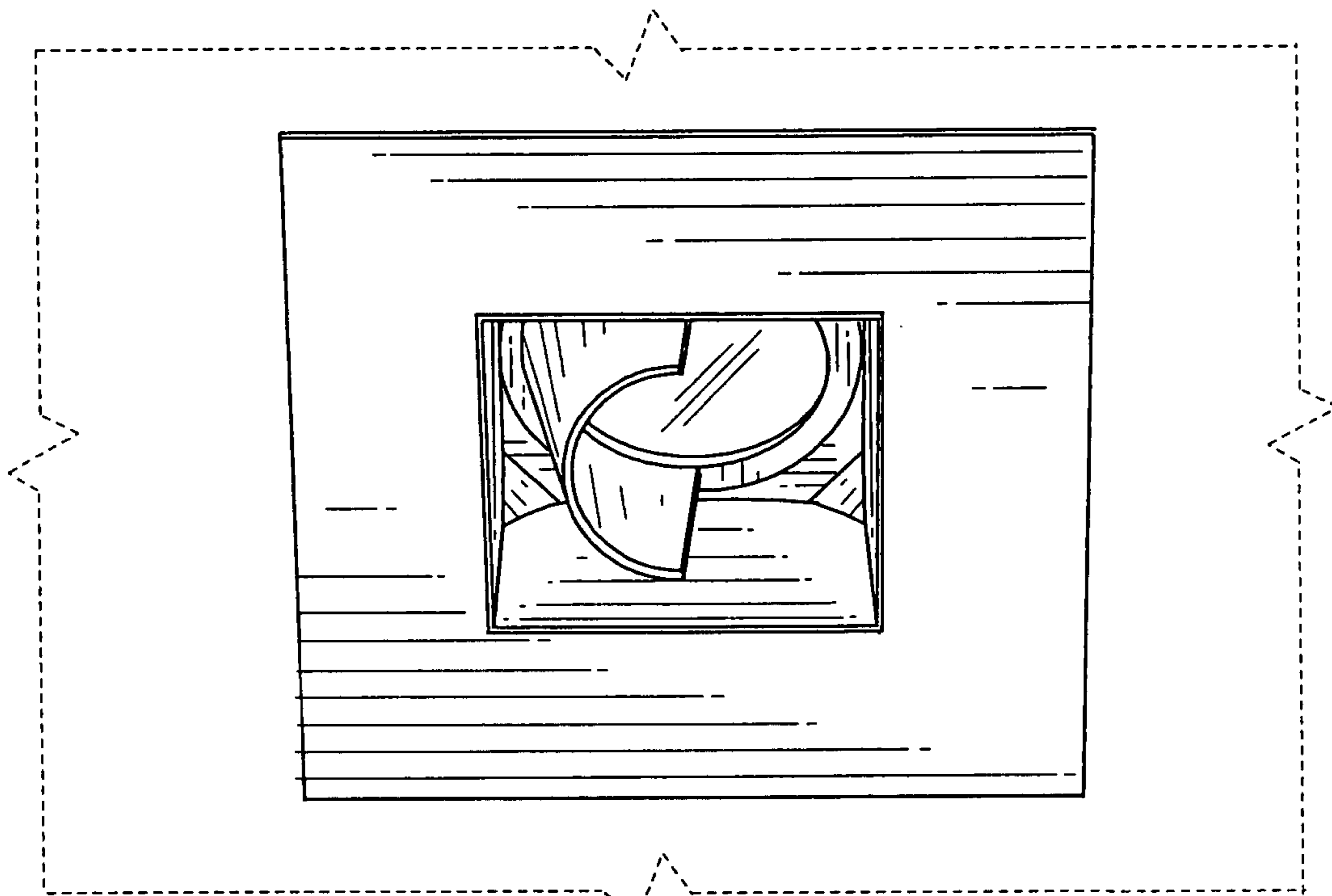

Fig. 3

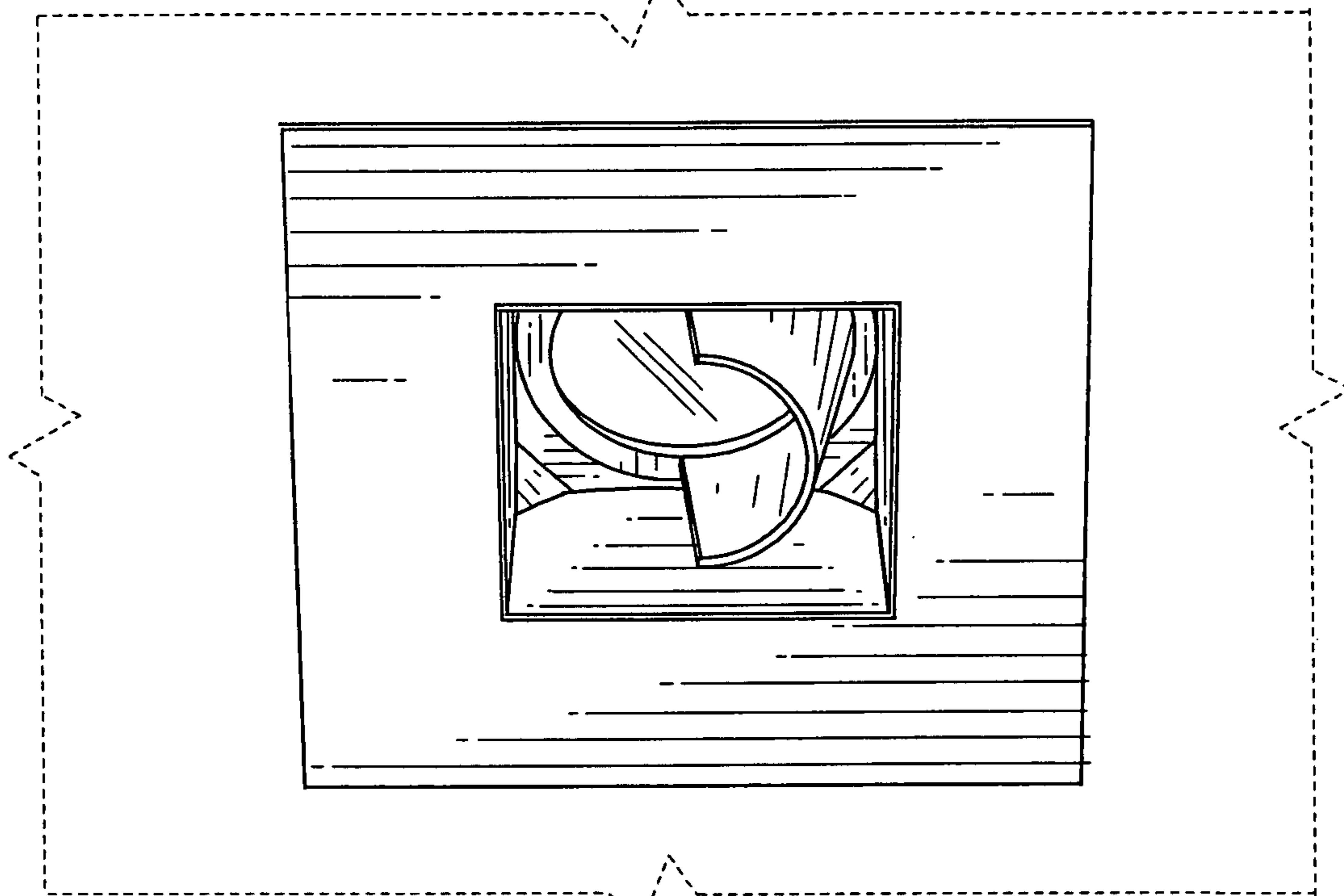

Fig. 4

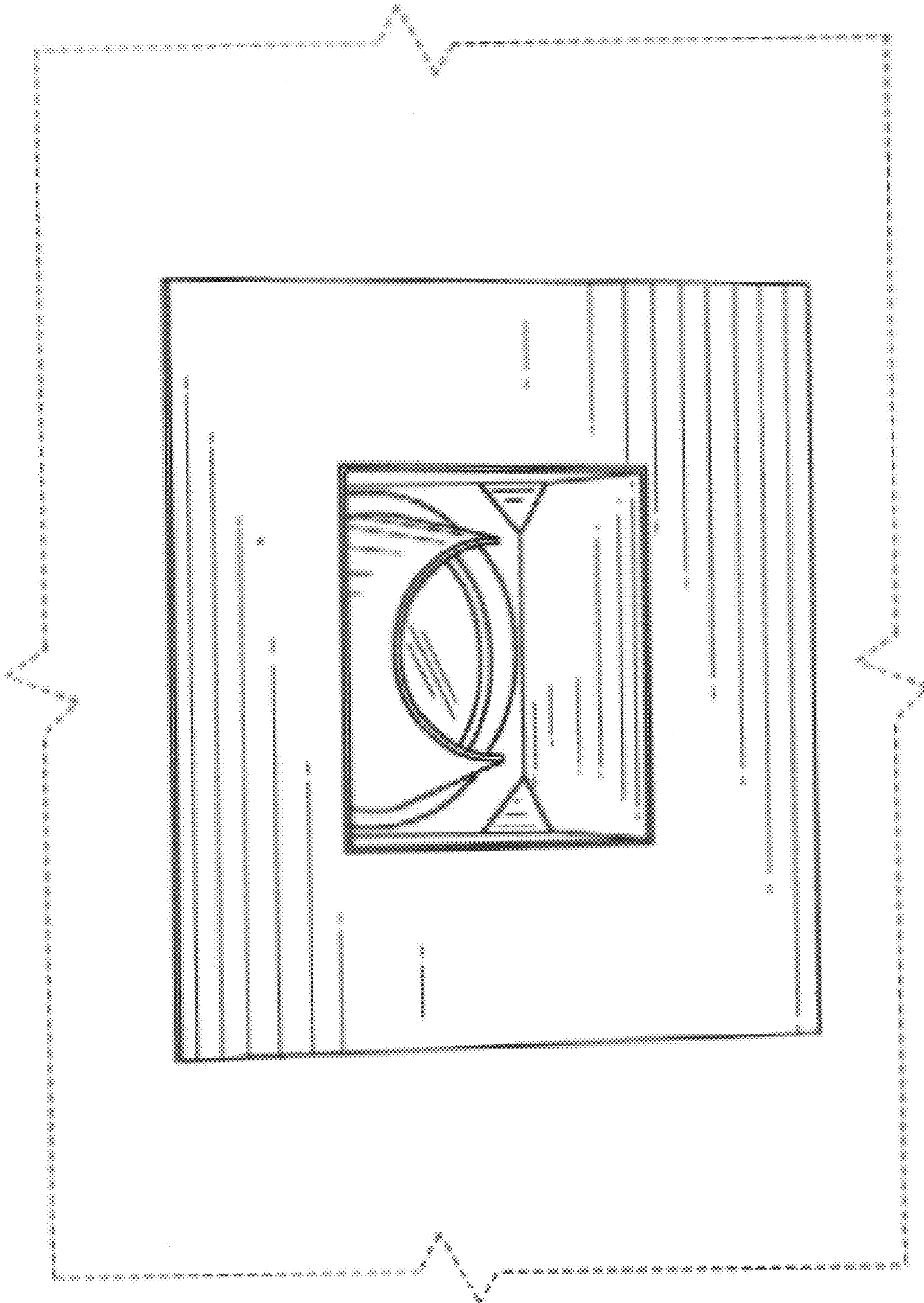

Fig. 5