



US00D558346S

(12) **United States Design Patent**
Darnold et al.

(10) **Patent No.:** **US D558,346 S**

(45) **Date of Patent:** **** Dec. 25, 2007**

(54) **PERIODONTAL SCALING TIP FOR
ULTRASONIC DENTAL HANDPIECE**

(75) Inventors: **Leane Darnold**, Kirkwood, MO (US);
Doxey Phillips, Huntleigh, MO (US)

(73) Assignee: **Young Os, LC**, Fenton, MO (US)

(**) Term: **14 Years**

(21) Appl. No.: **29/250,082**

(22) Filed: **Nov. 1, 2006**

Related U.S. Application Data

(62) Division of application No. 29/199,700, filed on Feb. 18, 2004, now Pat. No. Des. 540,945.

(51) **LOC (8) Cl.** **24-03**

(52) **U.S. Cl.** **D24/152**

(58) **Field of Classification Search** D24/152-154,
D24/176, 146, 144; 81/426, 416; 433/159,
433/160, 80, 141

See application file for complete search history.

(56) **References Cited**

U.S. PATENT DOCUMENTS

D29,560 S *	11/1898	Greene	D24/152
D32,154 S *	1/1900	Harper	D24/152
3,645,255 A	2/1972	Robinson		
D237,187 S *	10/1975	Fattaleh	D24/146
4,283,175 A	8/1981	Nash		
D261,932 S *	11/1981	Bussiere	D24/152
D275,992 S *	10/1984	Detsch	D24/152
D283,045 S *	3/1986	Lynn	D24/146
4,731,019 A	3/1988	Martin		
D297,664 S *	9/1988	Brunner et al.	D24/152
5,094,617 A	3/1992	Carr		
5,098,292 A *	3/1992	Lazarof	433/141
5,197,875 A *	3/1993	Nerli	433/80
5,244,390 A	9/1993	Lazzara et al.		
5,567,153 A	10/1996	Foulkes et al.		
5,704,787 A	1/1998	Hickok et al.		
5,733,119 A	3/1998	Carr		

5,836,765 A	11/1998	Hickok		
D417,913 S *	12/1999	Szarmach	D24/152
D422,707 S *	4/2000	Bock	D24/176
D453,378 S *	2/2002	Mangione	D24/152
D459,476 S *	6/2002	Mangione	D24/152
D459,809 S *	7/2002	Mangione	D24/152

(Continued)

Primary Examiner—Charles A. Rademaker

(74) *Attorney, Agent, or Firm*—Polster, Lieder, Woodruff & Lucchesi, L.C.

(57) **CLAIM**

The ornamental design for a periodontal scaling tip for ultrasonic dental handpiece, as shown and described.

DESCRIPTION

FIG. 1 is a perspective view of a periodontal scaling tip for ultrasonic dental handpiece showing our new design;

FIG. 2 is a top plan view thereof;

FIG. 3 is a bottom plan view thereof;

FIG. 4 is a front elevation thereof;

FIG. 5 is a rear elevation thereof;

FIG. 6 is a right side elevation thereof;

FIG. 7 is a left side elevation thereof;

FIG. 8 is a perspective view of a modified embodiment of the design shown in FIGS. 1 through 7;

FIG. 9 is a top plan view thereof;

FIG. 10 is a bottom plan view thereof;

FIG. 11 is a front elevation thereof;

FIG. 12 is a rear elevation thereof;

FIG. 13 is a right side elevation thereof; and,

FIG. 14 is a left side elevation thereof.

The broken lines shown in the drawings represent environmental structures and are included for the purpose of illustration and form no part of the claimed design.

1 Claim, 3 Drawing Sheets

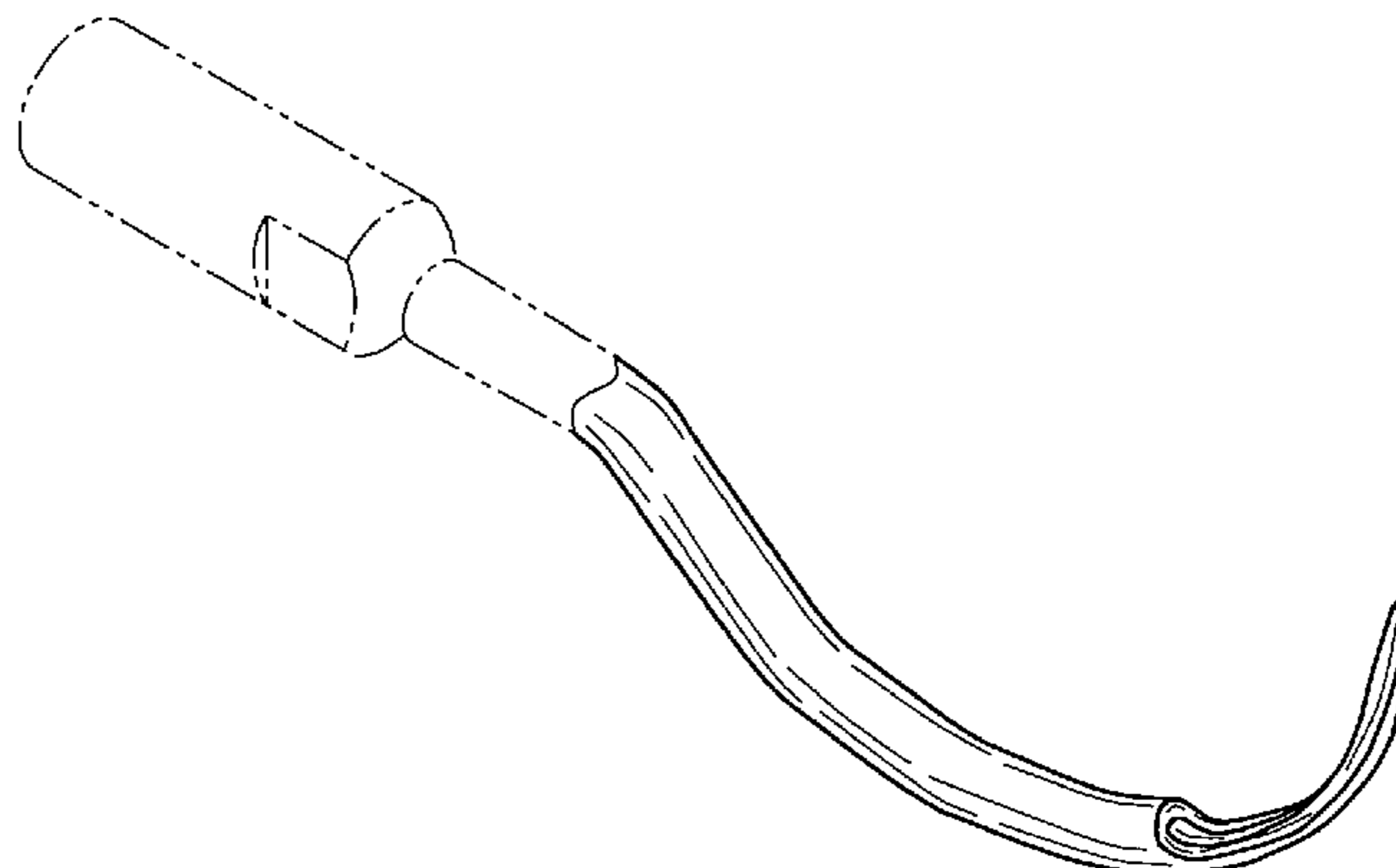
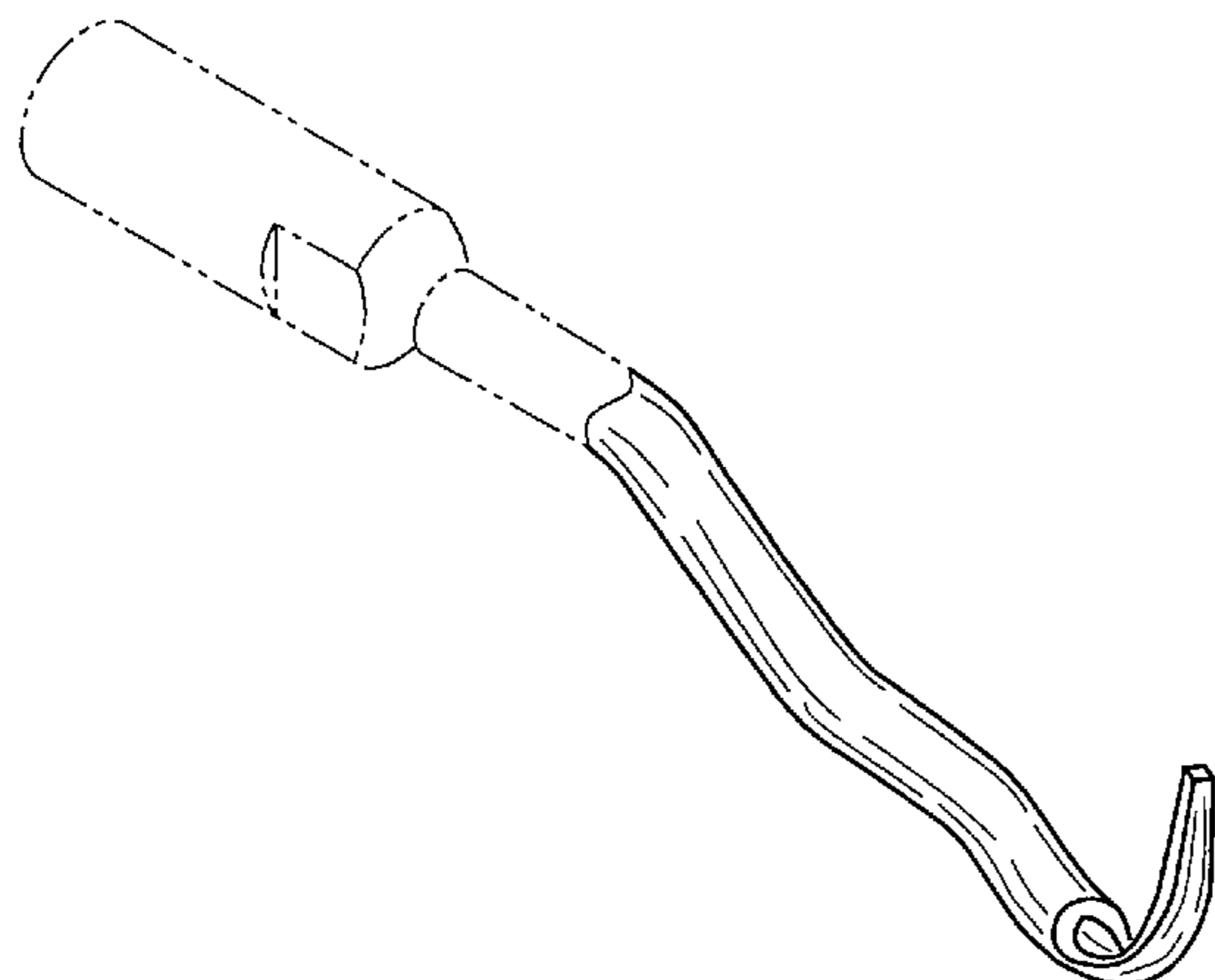

US D558,346 S

Page 2

U.S. PATENT DOCUMENTS

6,722,882 B2	4/2004	Buchanan					
D490,899 S *	6/2004	Gagnon	D24/152	D509,588 S *	9/2005	Vercellotti et al.	D24/144
D492,778 S *	7/2004	Narini	D24/146	2002/0072035 A1	6/2002	Hickok	
D494,678 S *	8/2004	Kemeny et al.	D24/152	2003/0096213 A1	5/2003	Hickok et al.	
D504,948 S *	5/2005	Dragan et al.	D24/152	2003/0157458 A1	8/2003	Buchanan	
				2004/0214138 A1*	10/2004	Senn et al.	433/141

* cited by examiner

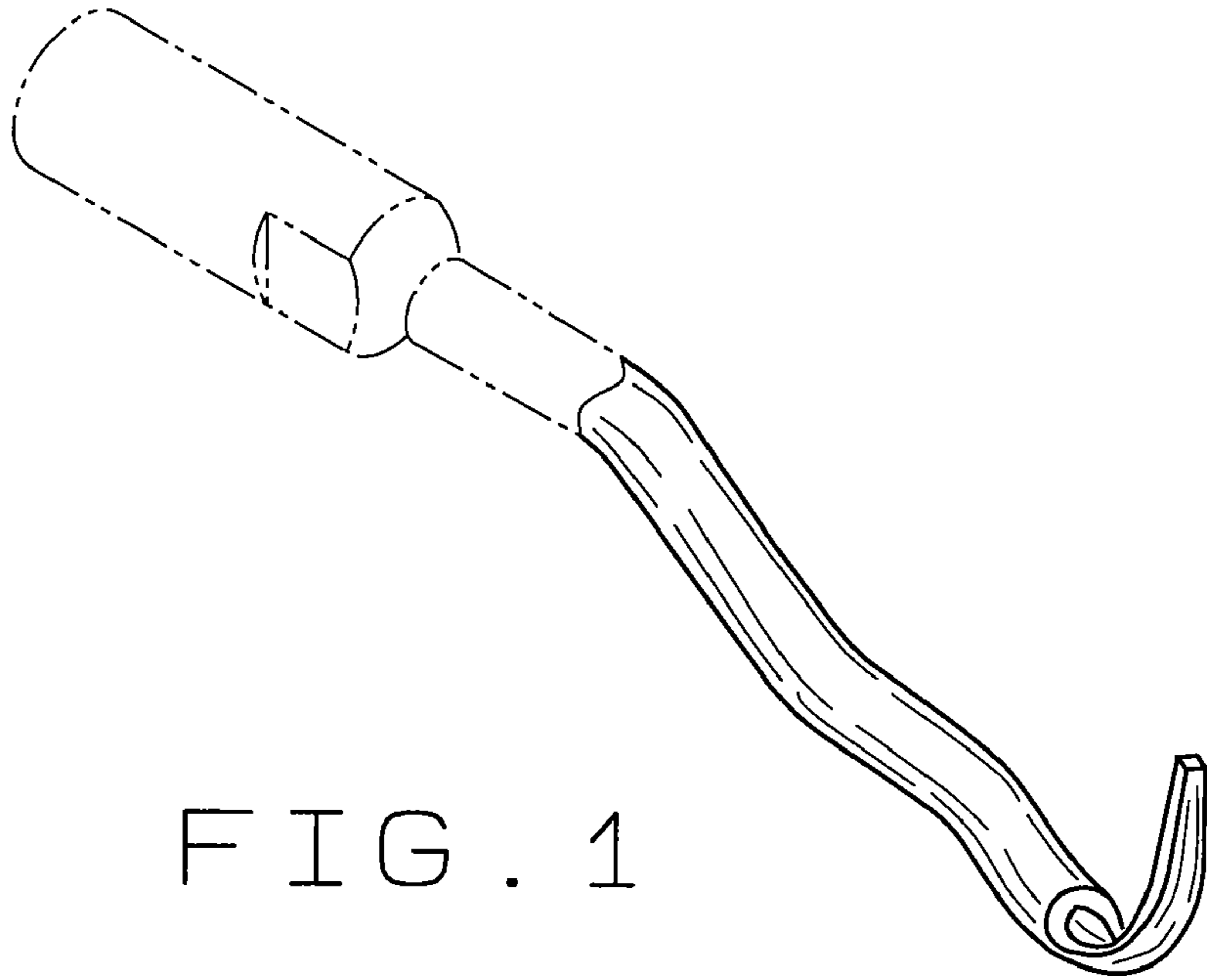

FIG. 1

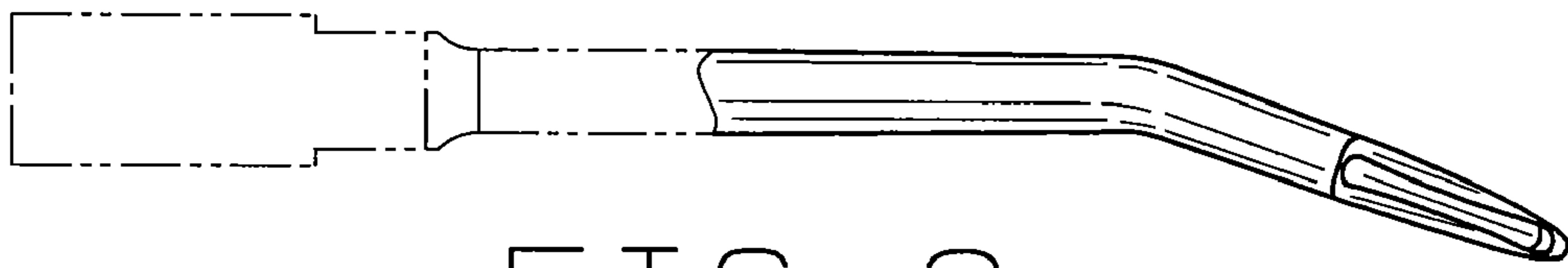

FIG. 2

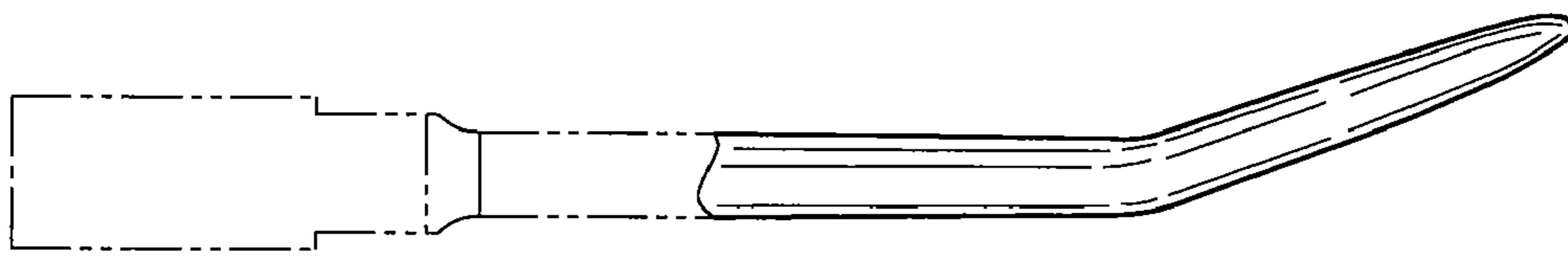

FIG. 3

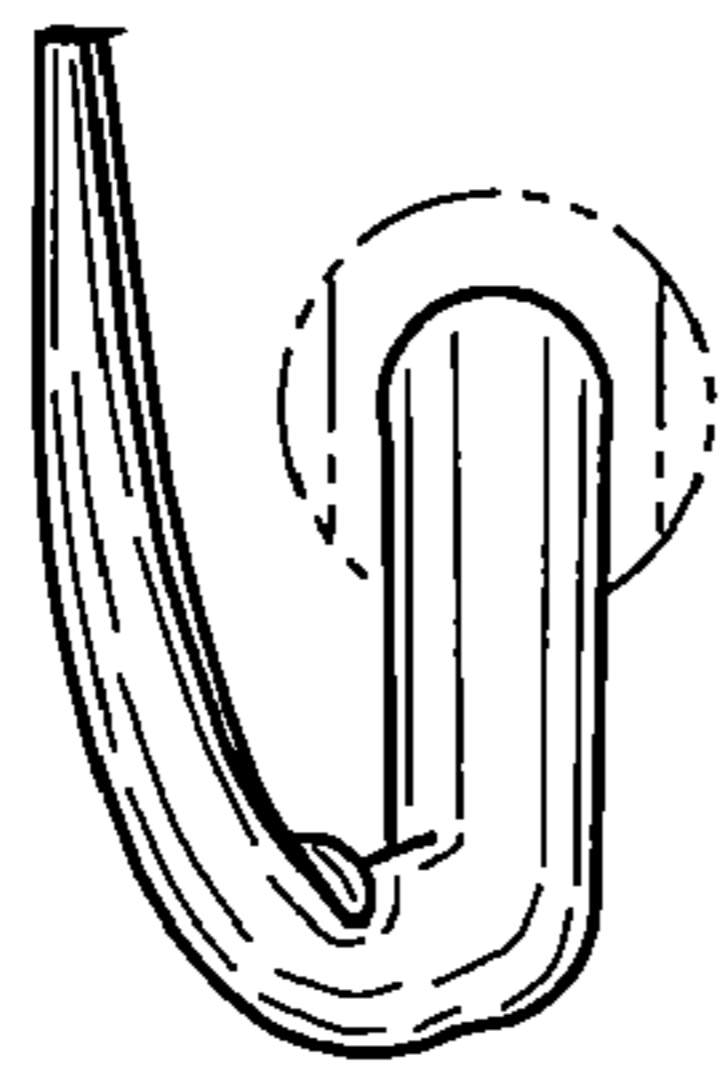

FIG. 4

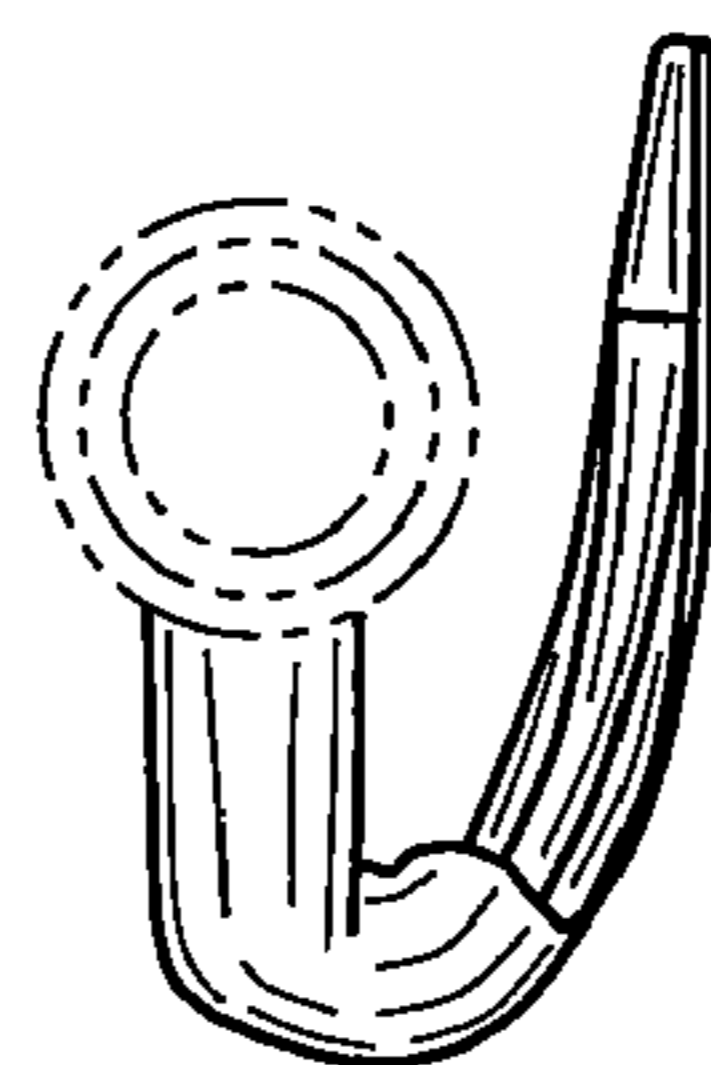

FIG. 5

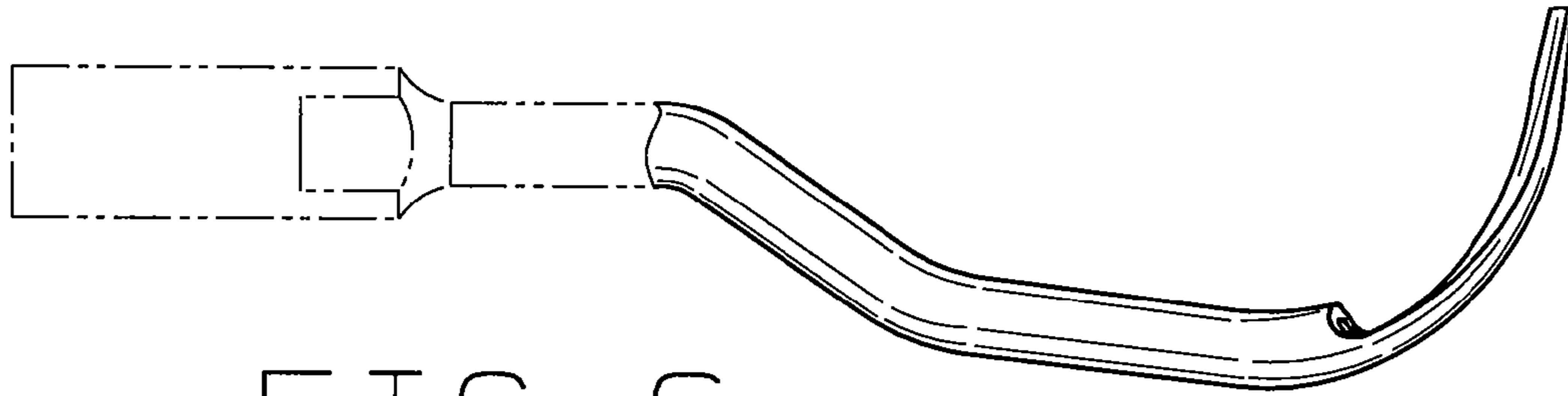

FIG. 6

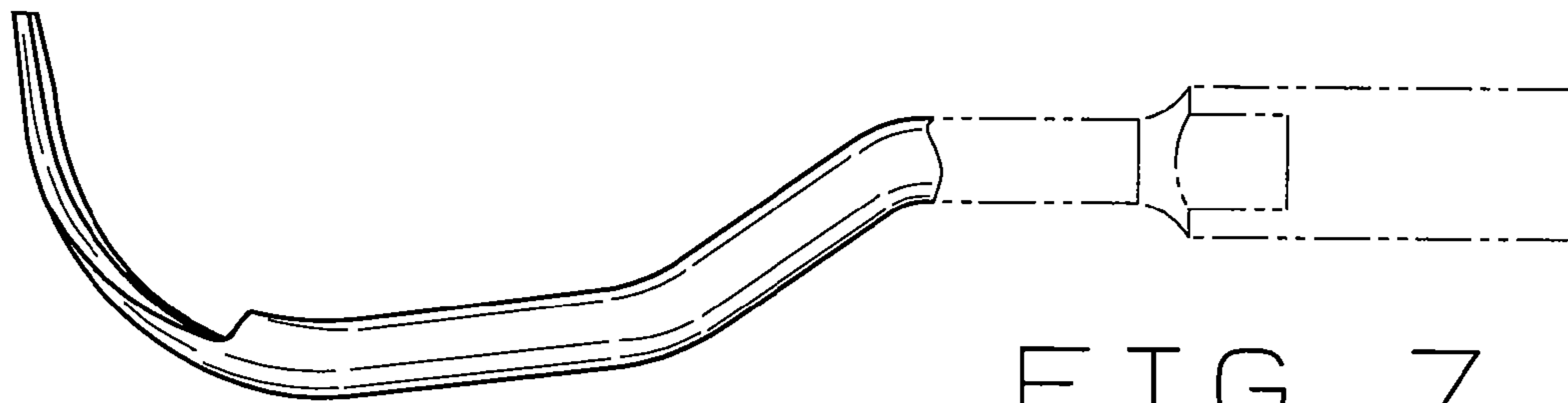

FIG. 7

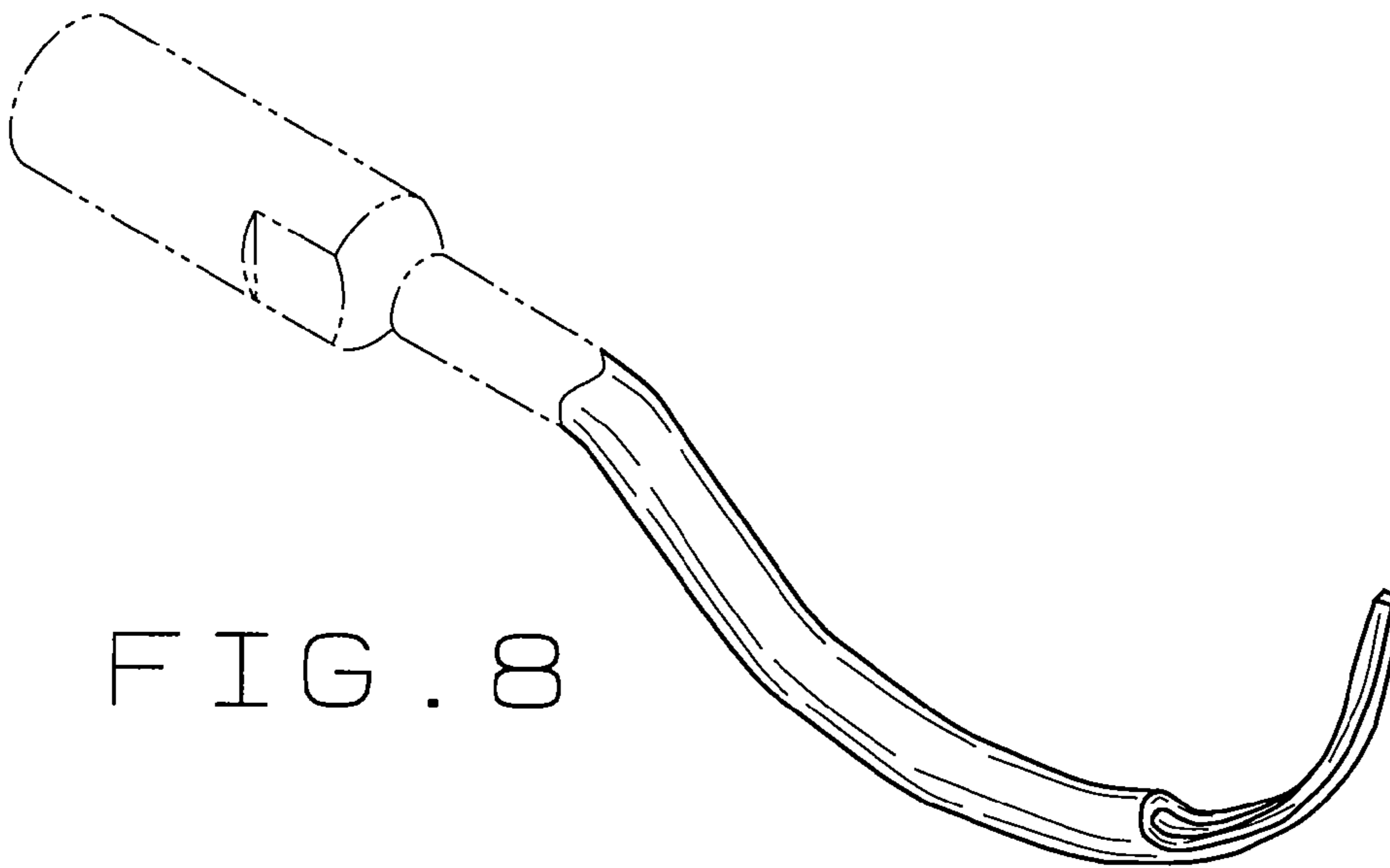

FIG. 8

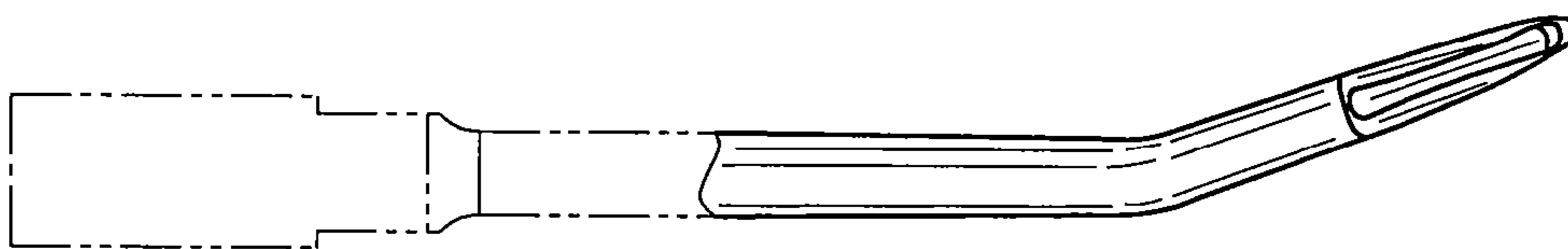

FIG. 9

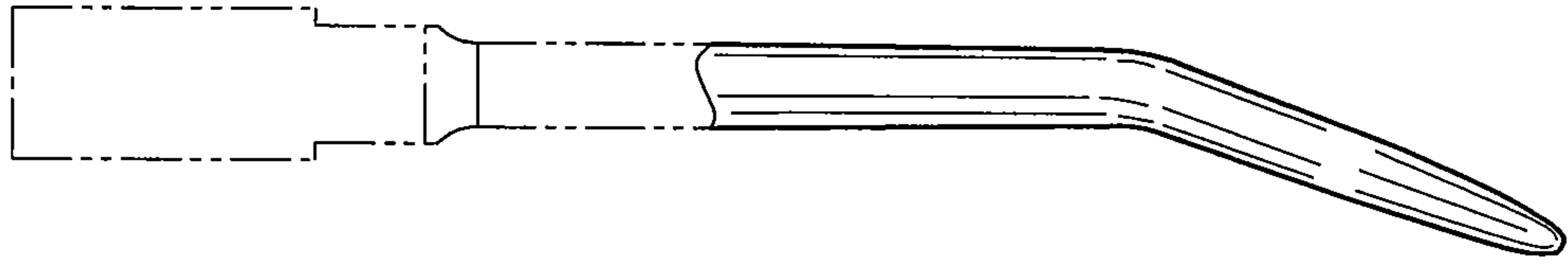

FIG. 10

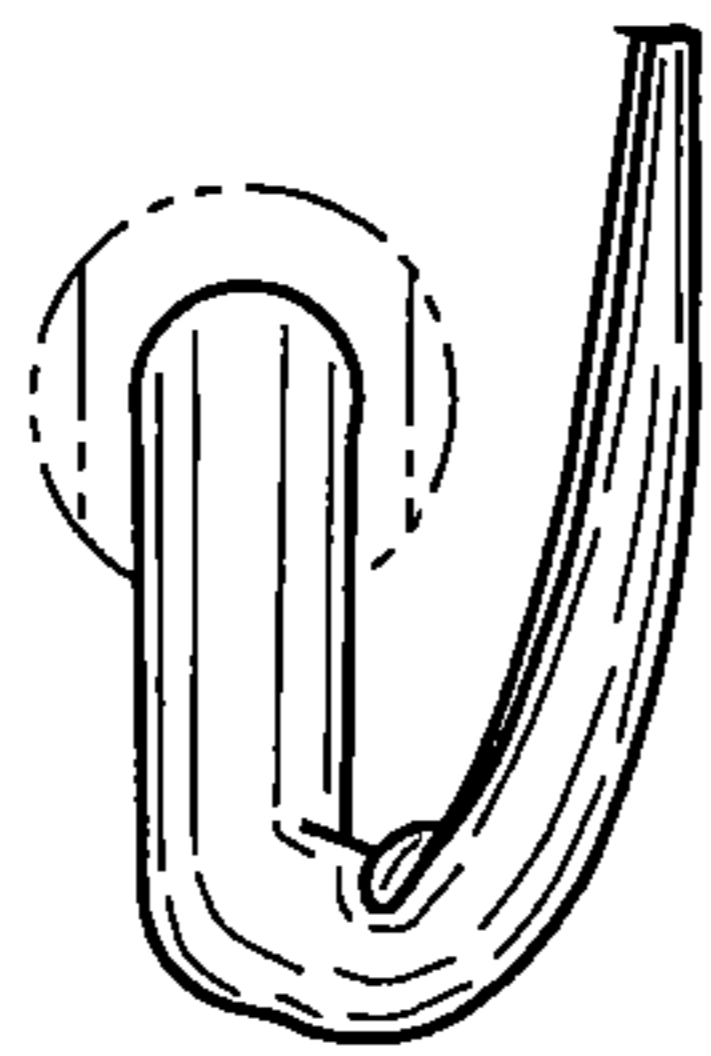

FIG. 11

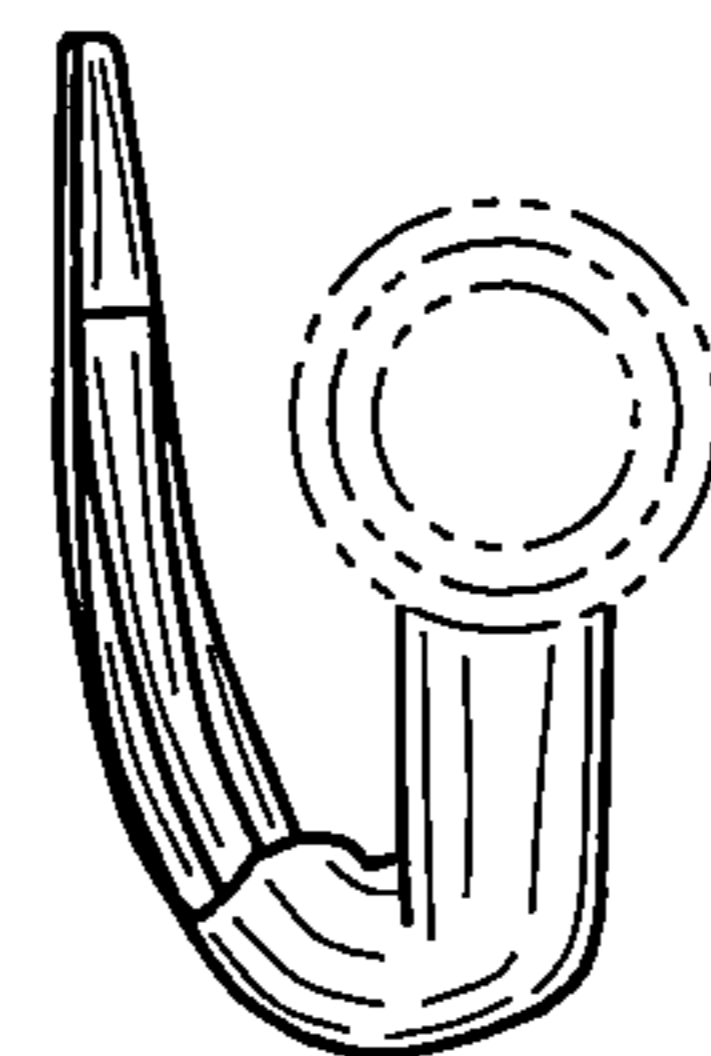

FIG. 12

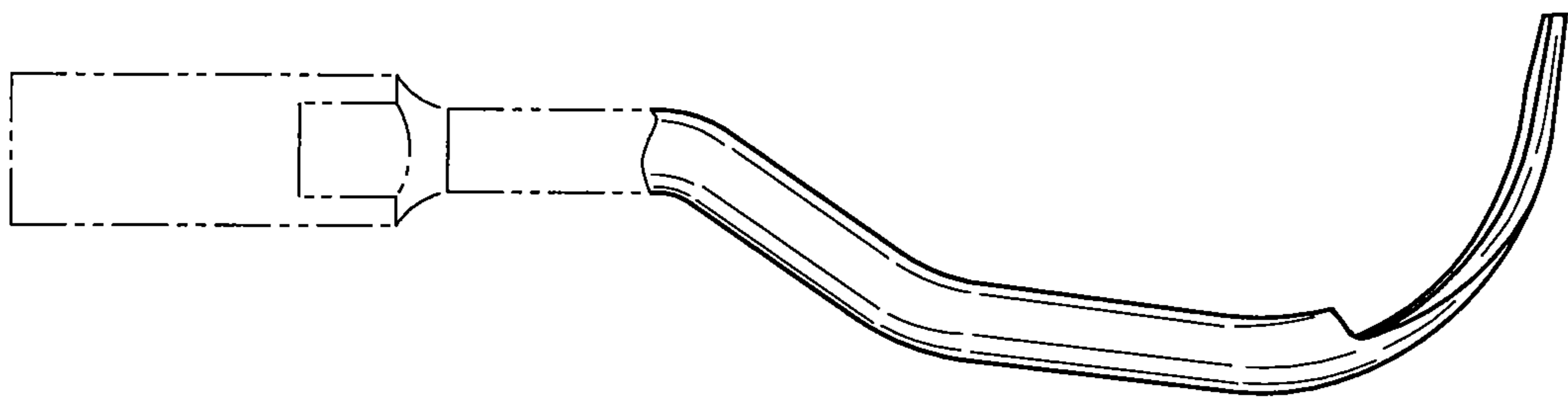

FIG. 13

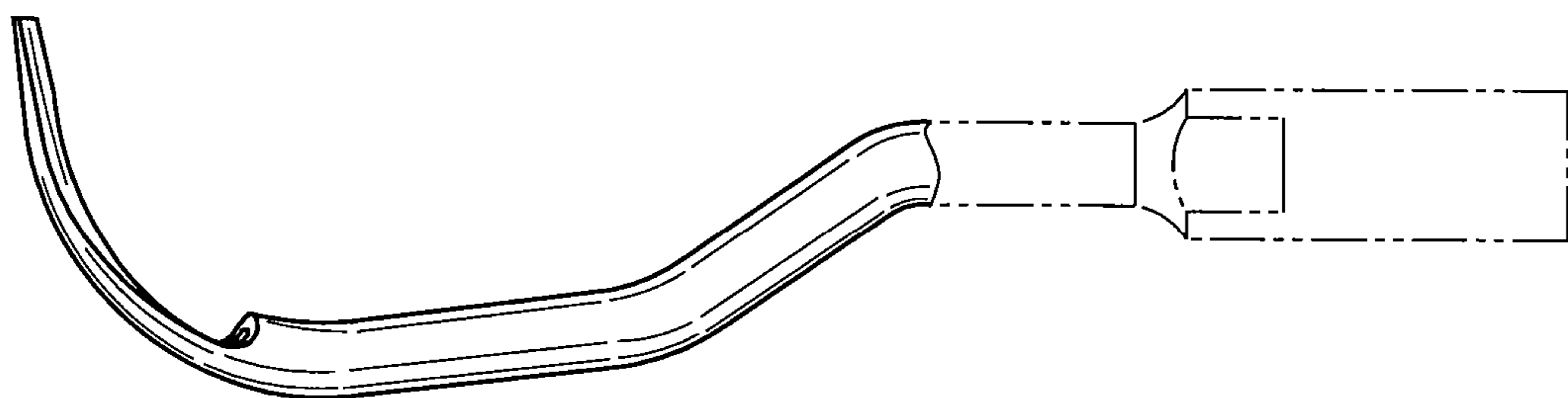

FIG. 14