



US00D558334S

(12) **United States Design Patent** (10) **Patent No.:** **US D558,334 S**  
**Stallard et al.** (45) **Date of Patent:** **\*\* Dec. 25, 2007**

(54) **RESPIRATORY MASK**

(56) **References Cited**

(75) Inventors: **Philip Thomas Stallard**, Denistone East (AU); **Susan Robyn Lynch**, Epping (AU); **Eva Ng**, Double Bay (AU); **Errol Savio Alex D'Souza**, Hornsby (AU); **Robin Garth Hitchcock**, North Parramatta (AU); **Vincent Chu**, Little Bay (AU); **Matthew Eves**, Carlington (AU); **Alison Oldenburg**, Crows Nest (AU); **David John Worboys**, Belrose (AU); **Daniel Robert Judson**, Lapstone (AU); **Lee James Veliss**, West Ryde (AU); **Scott Alexander Howard**, Harbord (AU); **Aaron Samuel Davidson**, Newport (AU); **Steven John Lubke**, Stanmore (AU); **James William Charles Vandyke**, Belrose (AU); **Murray William Lee**, Quakers Hill (AU)

U.S. PATENT DOCUMENTS

D430,663 S 9/2000 Smart  
D464,427 S 10/2002 Smart  
D464,728 S 10/2002 Paul  
D493,885 S 8/2004 Raje  
6,860,269 B2 \* 3/2005 Kwok et al. .... 128/207.11  
D519,207 S \* 4/2006 Raje et al. .... D24/110.1  
2004/0118406 A1 \* 6/2004 Lithgow et al. .... 128/206.24  
2005/0172969 A1 8/2005 Ging

FOREIGN PATENT DOCUMENTS

WO WO 2005/021075 A1 3/2005

\* cited by examiner

*Primary Examiner*—Antoine D. Davis  
*Assistant Examiner*—Christopher Lee  
(74) *Attorney, Agent, or Firm*—Nixon & Vanderhye P.C.

(73) Assignee: **ResMed Limited**, Bella Vista (AU)

(\*\*) Term: **14 Years**

(21) Appl. No.: **29/251,711**

(22) Filed: **Jan. 12, 2006**

(51) **LOC (8) Cl.** ..... **29-02**

(52) **U.S. Cl.** ..... **D24/110.1; D24/110.4; D24/110.5**

(58) **Field of Classification Search** ..... D24/110.1, D24/110.4, 110.5; 128/205.25, 206.21, 206.26, 128/206.27, 207.11, 207.13, 207.17

See application file for complete search history.

(57) **CLAIM**

The ornamental design for a respiratory mask, as shown and described.

**DESCRIPTION**

FIG. 1 is a front perspective view of a respiratory mask according to our design;  
FIG. 2 is a front view thereof;  
FIG. 3 is a rear view thereof;  
FIG. 4 is a left side view thereof;  
FIG. 5 is a right side view thereof;  
FIG. 6 is a top view thereof;  
FIG. 7 is a bottom view thereof; and,  
FIG. 8 is a rear perspective view thereof.

**1 Claim, 8 Drawing Sheets**

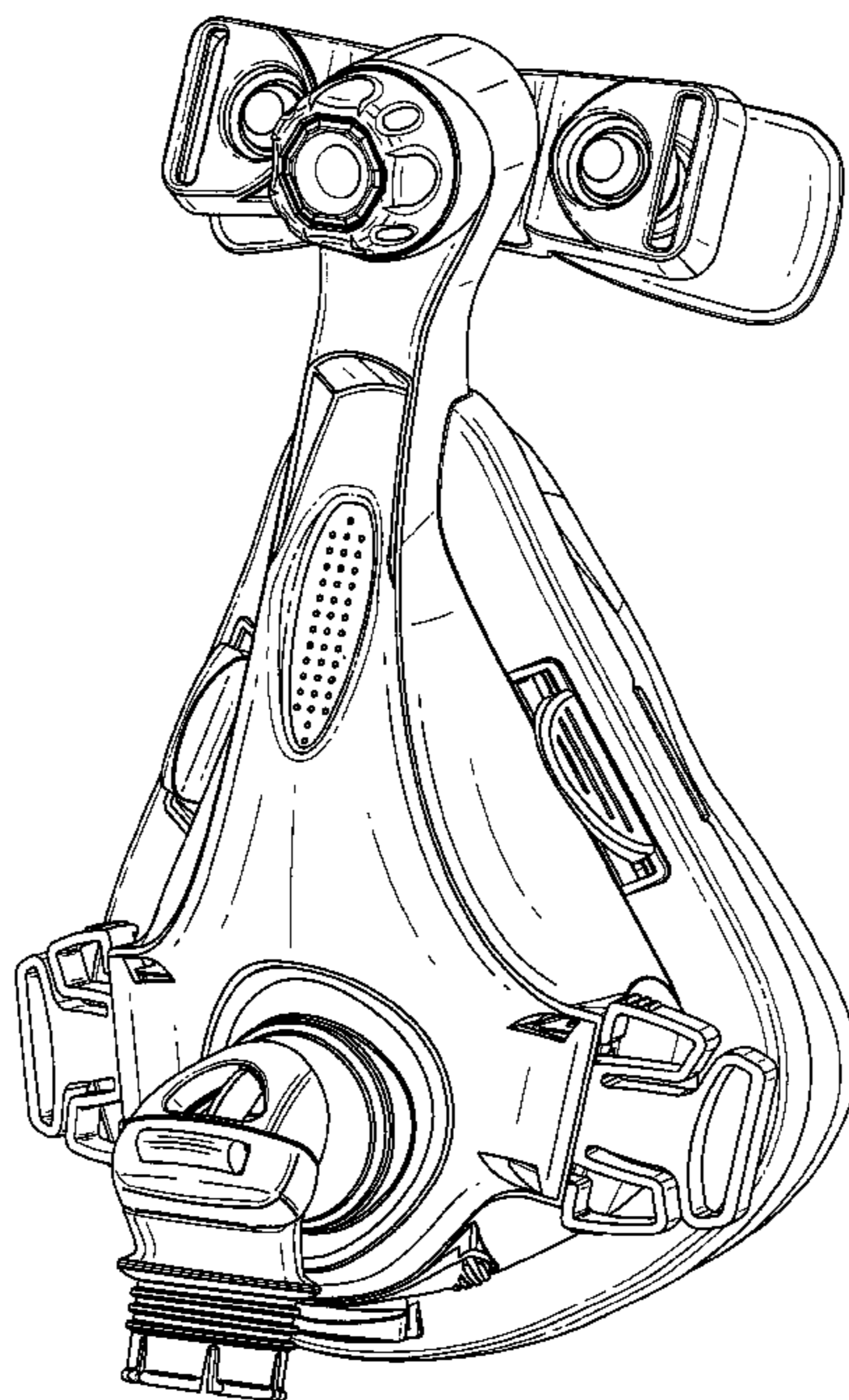

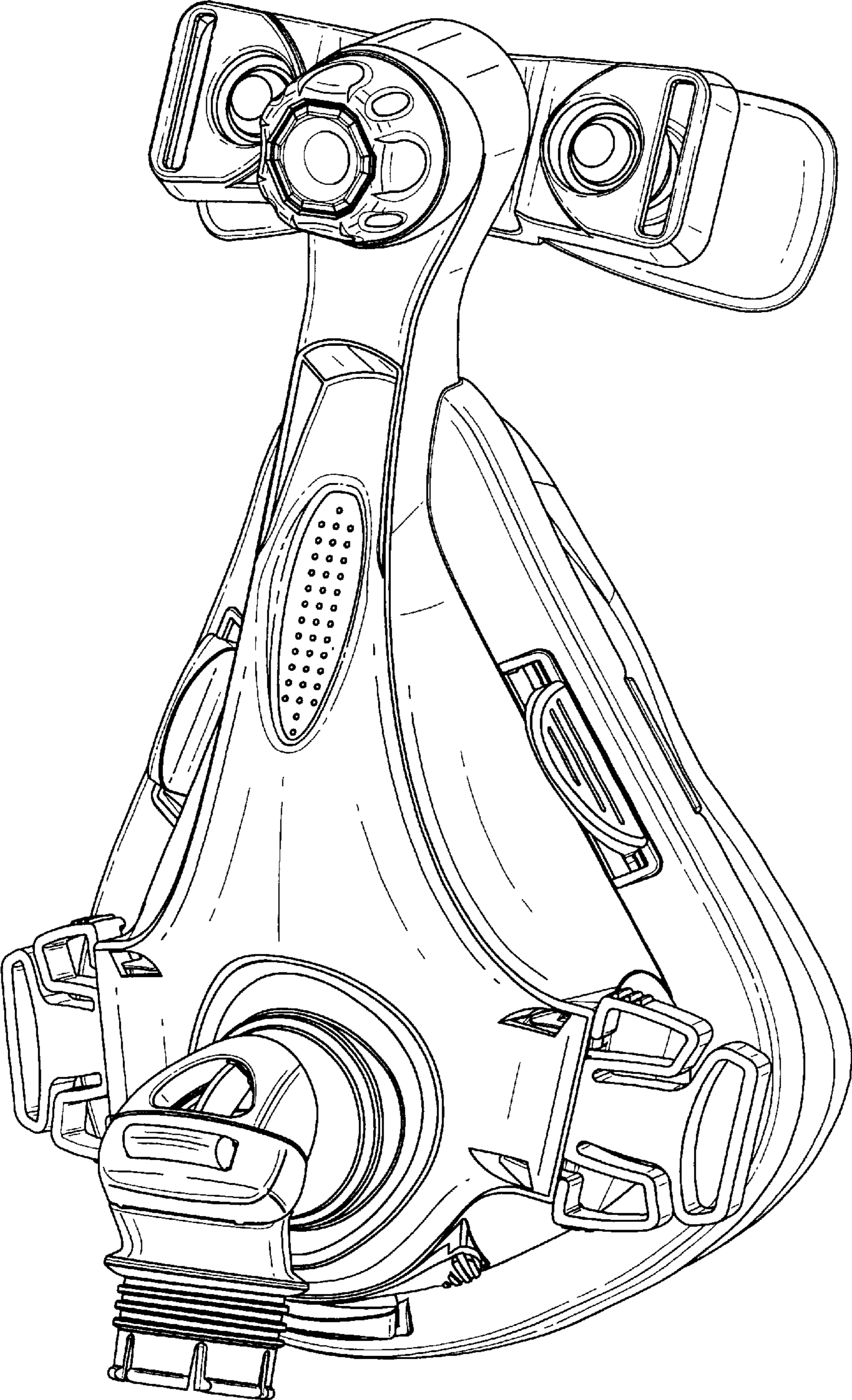

Fig. 1

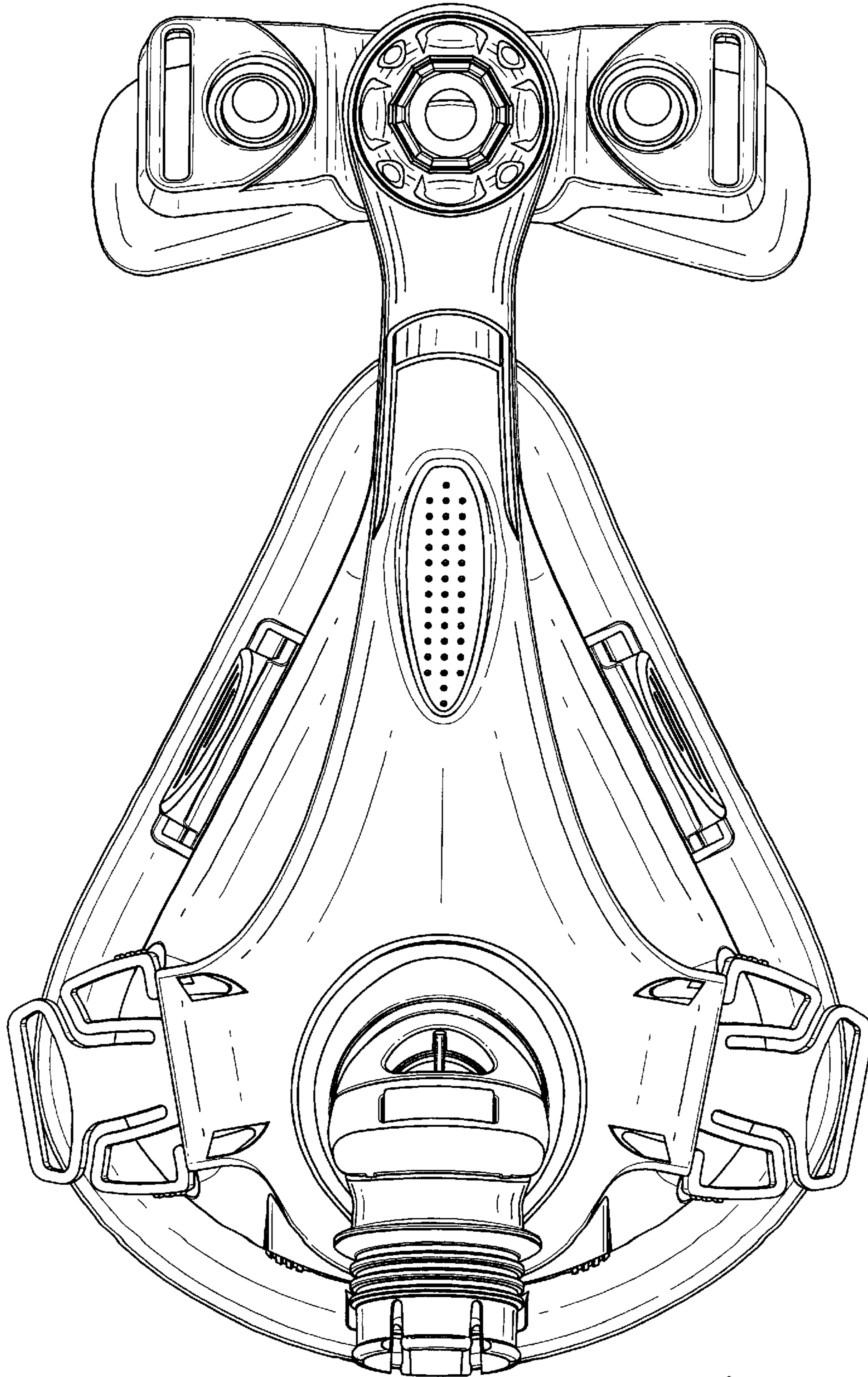

Fig. 2

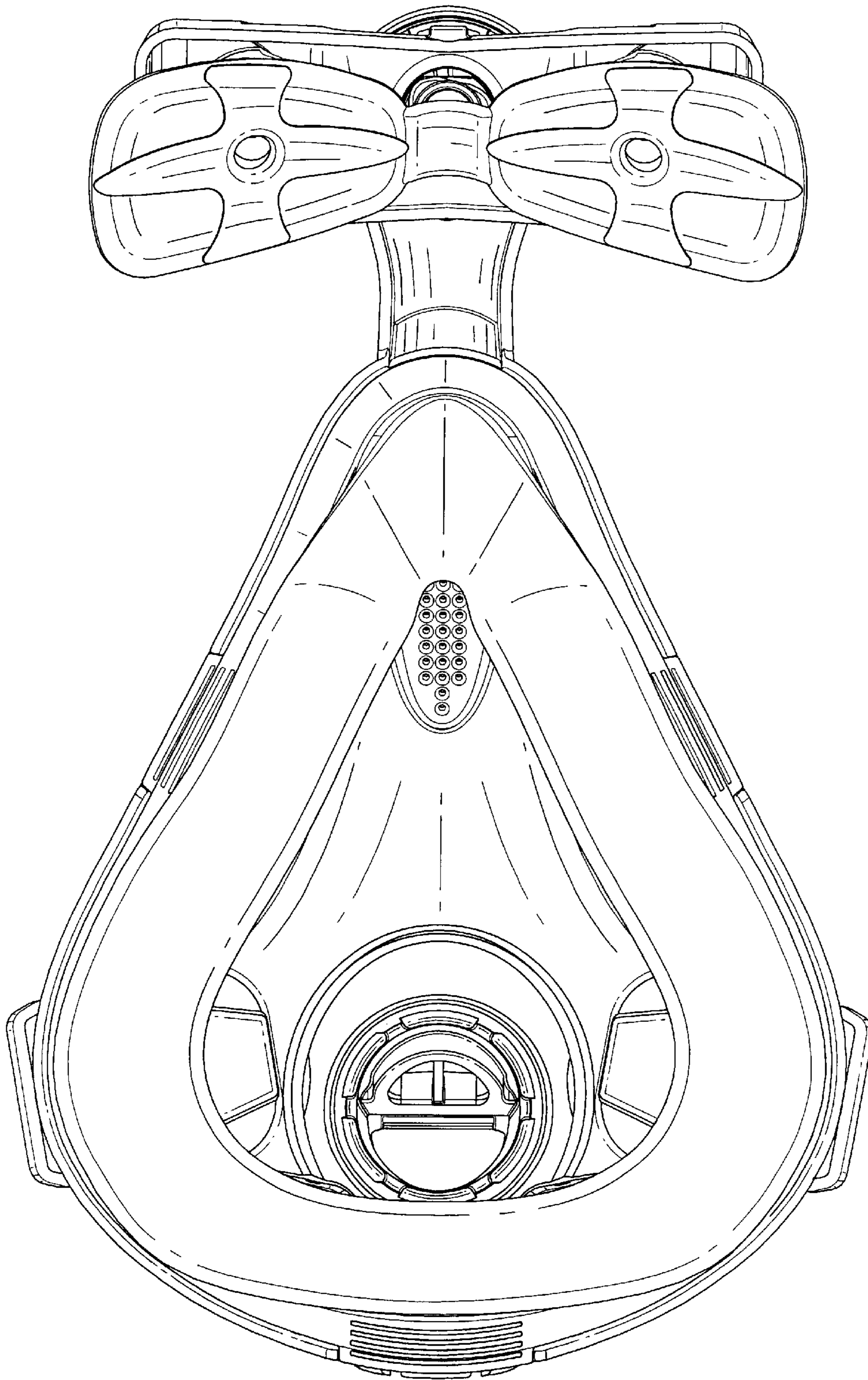

Fig. 3

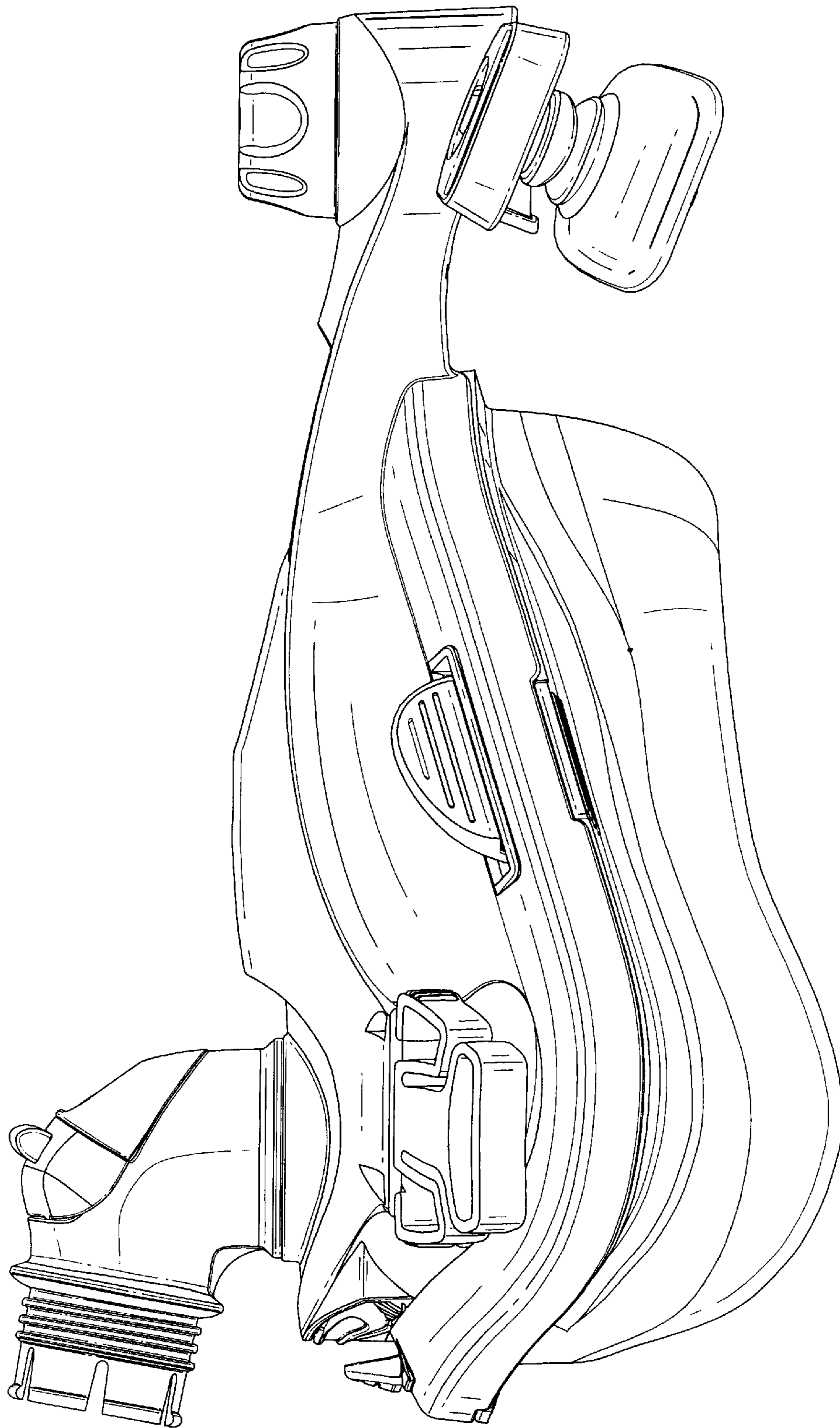

Fig. 4

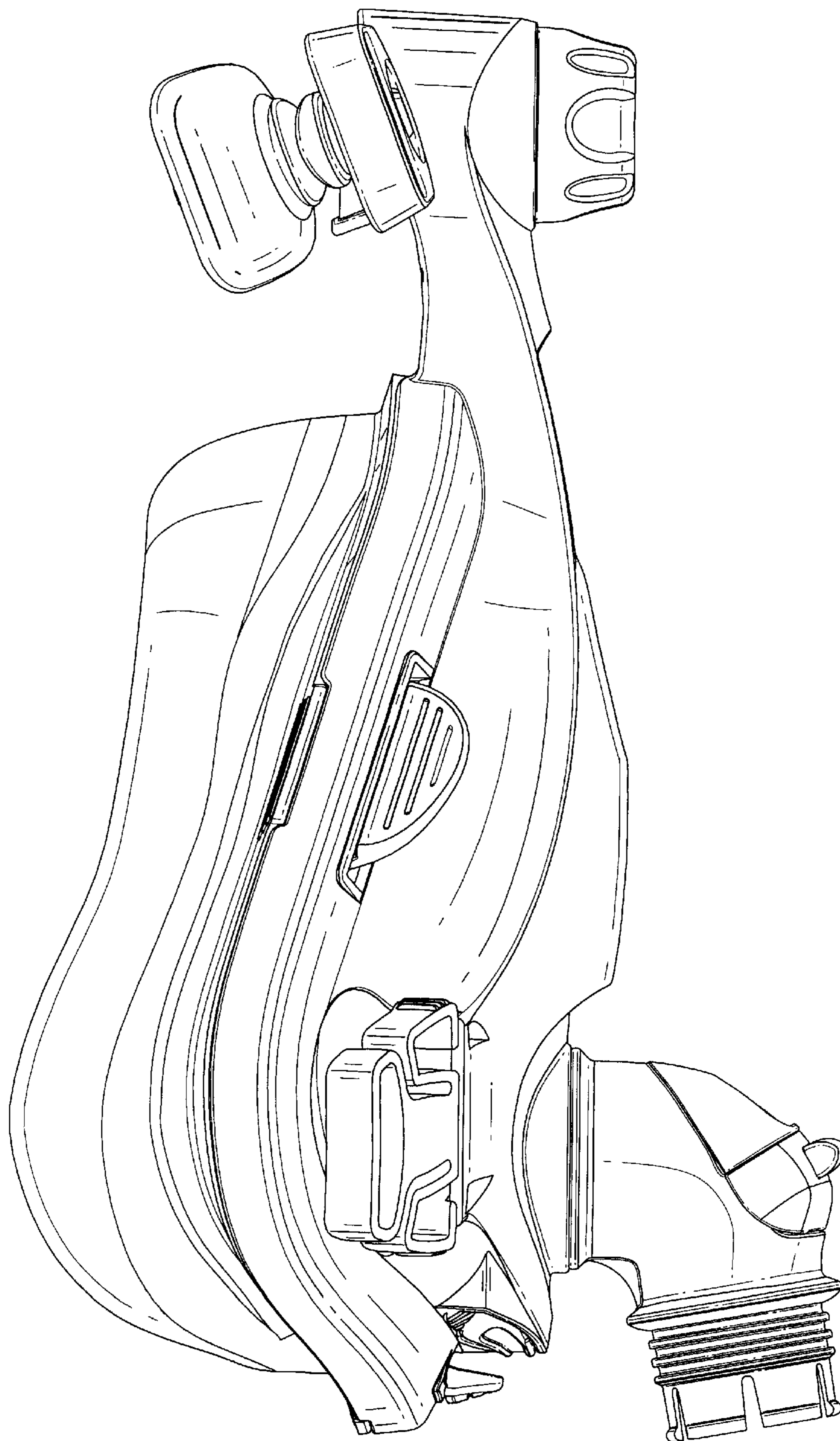

Fig. 5

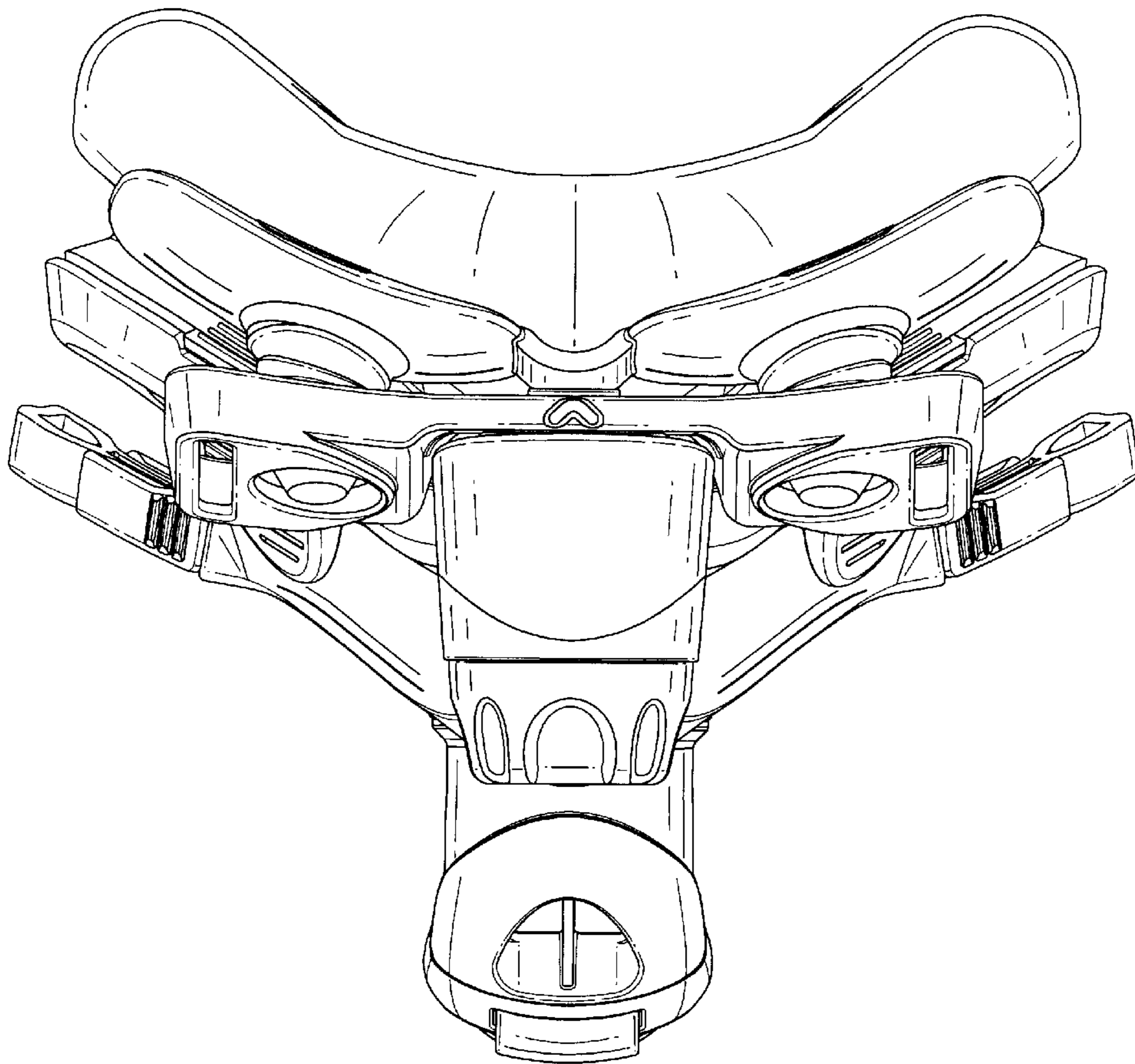

Fig. 6

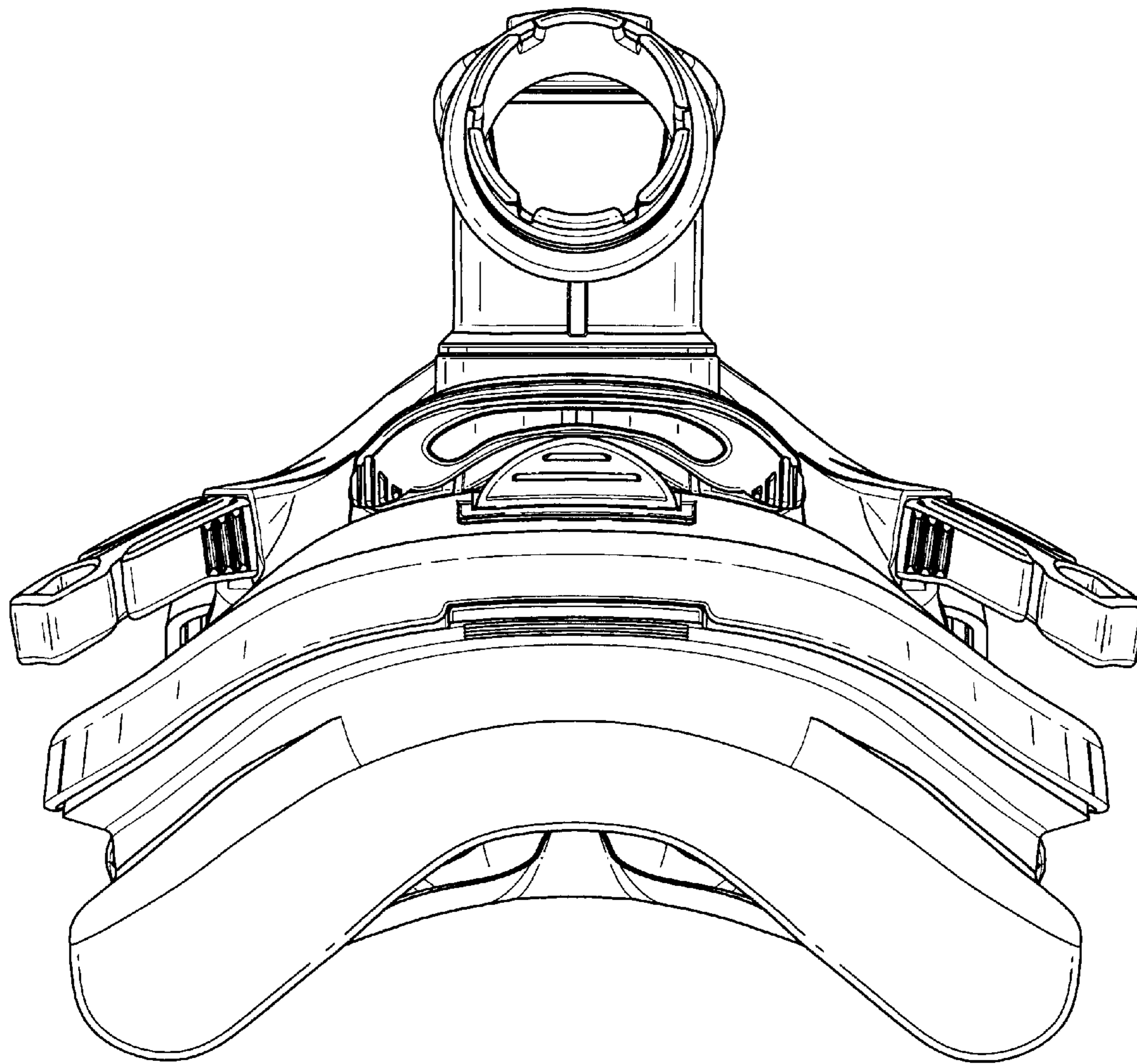

Fig. 7



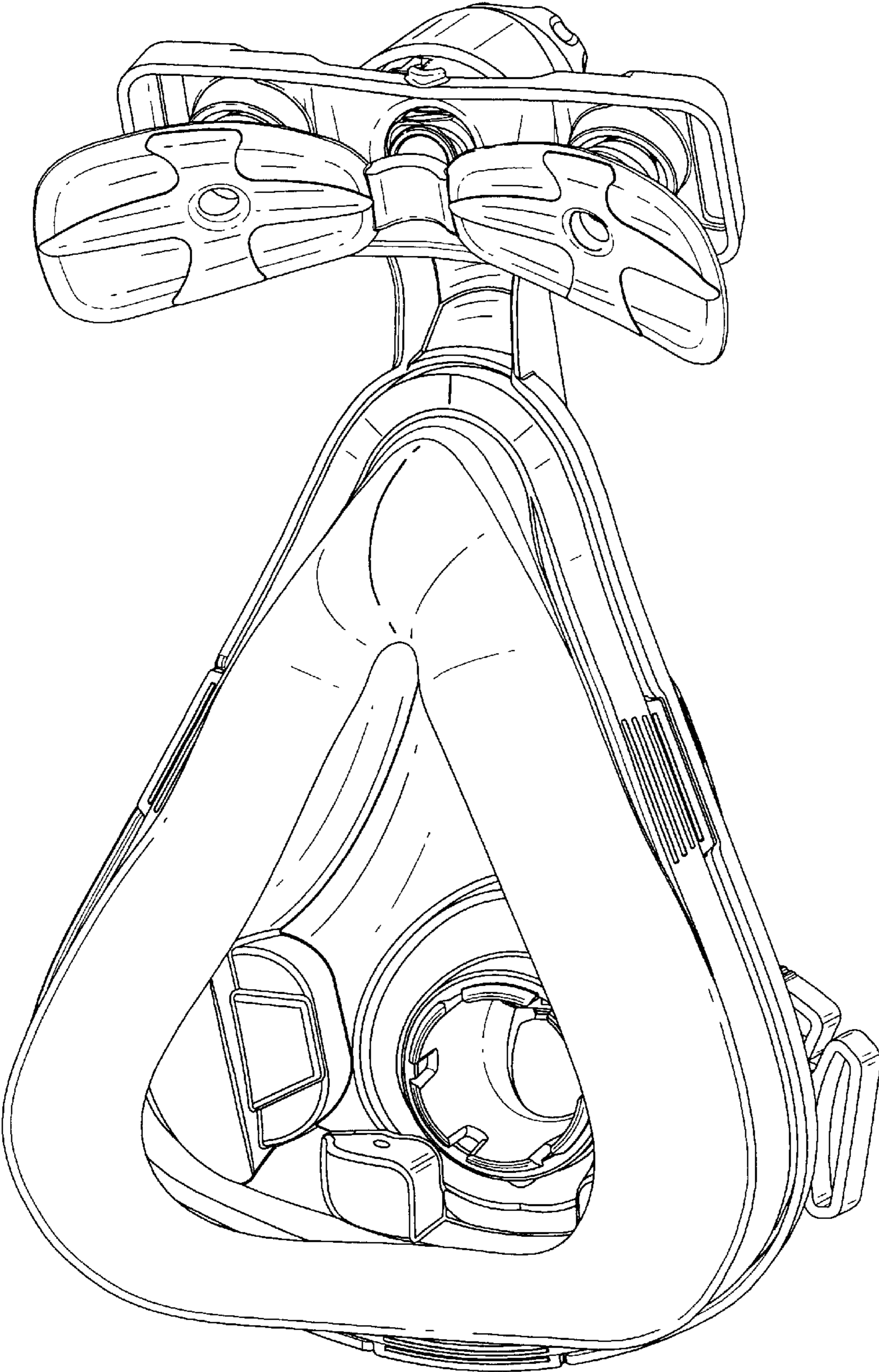

Fig. 8