



US00D558218S

(12) **United States Design Patent** (10) **Patent No.:** **US D558,218 S**
Kwon et al. (45) **Date of Patent:** **** Dec. 25, 2007**

(54) **DISPLAY WITH GRAPHIC USER INTERFACE**
 (75) Inventors: **Giang-Yoon Kwon**, Guri (KR); **Sung-Hee Kim**, Seoul (KR); **Hye-Sang Jun**, Seoul (KR); **Mi-Su Jung**, Suwon (KR); **Jee-Young Her**, Seoul (KR)
 (73) Assignee: **Samsung Electronics Co., Ltd.**, Suwon-Si (KR)

(**) Term: **14 Years**
 (21) Appl. No.: **29/264,283**
 (22) Filed: **Aug. 8, 2006**

(30) **Foreign Application Priority Data**
 Feb. 10, 2006 (KR) 30-2006-0005035

(51) **LOC (8) Cl.** **14-04**
 (52) **U.S. Cl.** **D14/486**
 (58) **Field of Classification Search** D14/485-95;
 345/592, 594, 628, 629; 715/505, 509, 517,
 715/526, 528, 700, 703, 714, 716, 717, 718,
 715/719, 720, 721, 722, 723, 726, 727, 728,
 715/730, 762, 763, 768, 771, 780, 781, 783,
 715/790, 792, 797, 808, 809, 810, 825, 828,
 715/829, 835, 837, 838, 840, 841, 842, 843,
 715/844, 845, 846, 864, 867, 902, 908, 961,
 715/963, 975

See application file for complete search history.

(56) **References Cited**
 U.S. PATENT DOCUMENTS

5,966,114 A * 10/1999 Ito et al. 345/628
 D445,426 S * 7/2001 Wang et al. D14/486

D464,660 S * 10/2002 Weng et al. D14/488
 6,879,350 B2 * 4/2005 Kwon et al. 348/569
 D522,017 S * 5/2006 Fong et al. D14/488
 7,043,691 B1 * 5/2006 Kwon et al. 715/705
 D523,442 S * 6/2006 Hiramatsu D14/488
 2004/0119758 A1 * 6/2004 Grossman et al. 345/839
 2005/0235209 A1 * 10/2005 Morita et al. 715/716
 2006/0031776 A1 * 2/2006 Glein et al. 715/779
 2006/0224962 A1 * 10/2006 Ostojic et al. 715/716
 2007/0143711 A1 * 6/2007 van Wyk et al. 715/838

* cited by examiner

Primary Examiner—Cathron C. Brooks
Assistant Examiner—Angela Lee
 (74) *Attorney, Agent, or Firm*—Staas & Halsey LLP

(57) **CLAIM**

The ornamental design for a display with graphic user interface, as shown and described.

DESCRIPTION

FIG. 1 is a perspective view of the display with graphic user interface showing our design;
 FIG. 2 is a front view thereof;
 FIG. 3 is a rear view thereof;
 FIG. 4 is a left side view thereof;
 FIG. 5 is a right side view thereof;
 FIG. 6 is a top plan view thereof;
 FIG. 7 is a bottom plan view thereof; and,
 FIG. 8 is an enlarged view of FIG. 2.

The broken line showing of the display is included for the purpose of illustrating a portion of the article and forms no part of the claimed design.

1 Claim, 6 Drawing Sheets

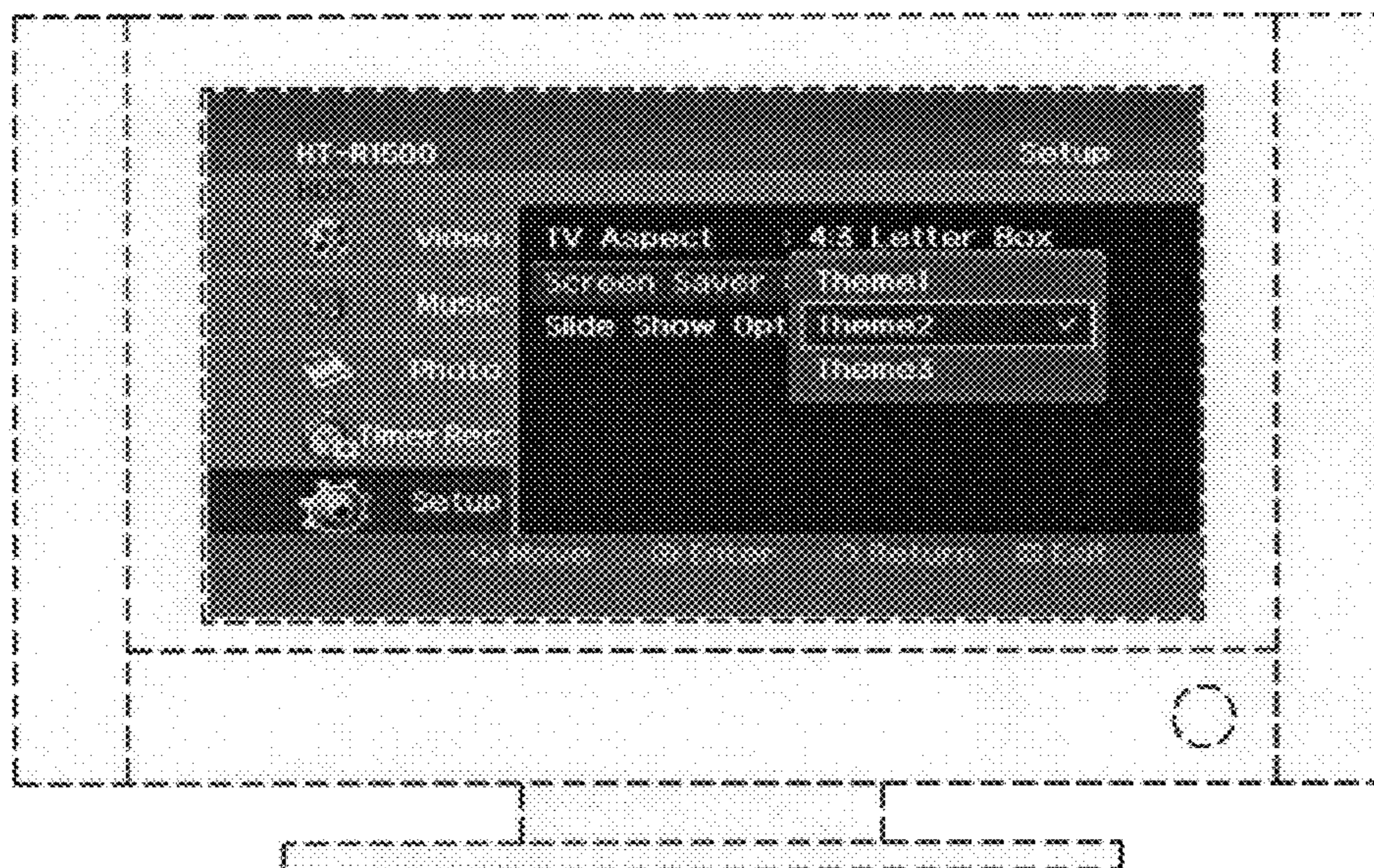

FIG. 1

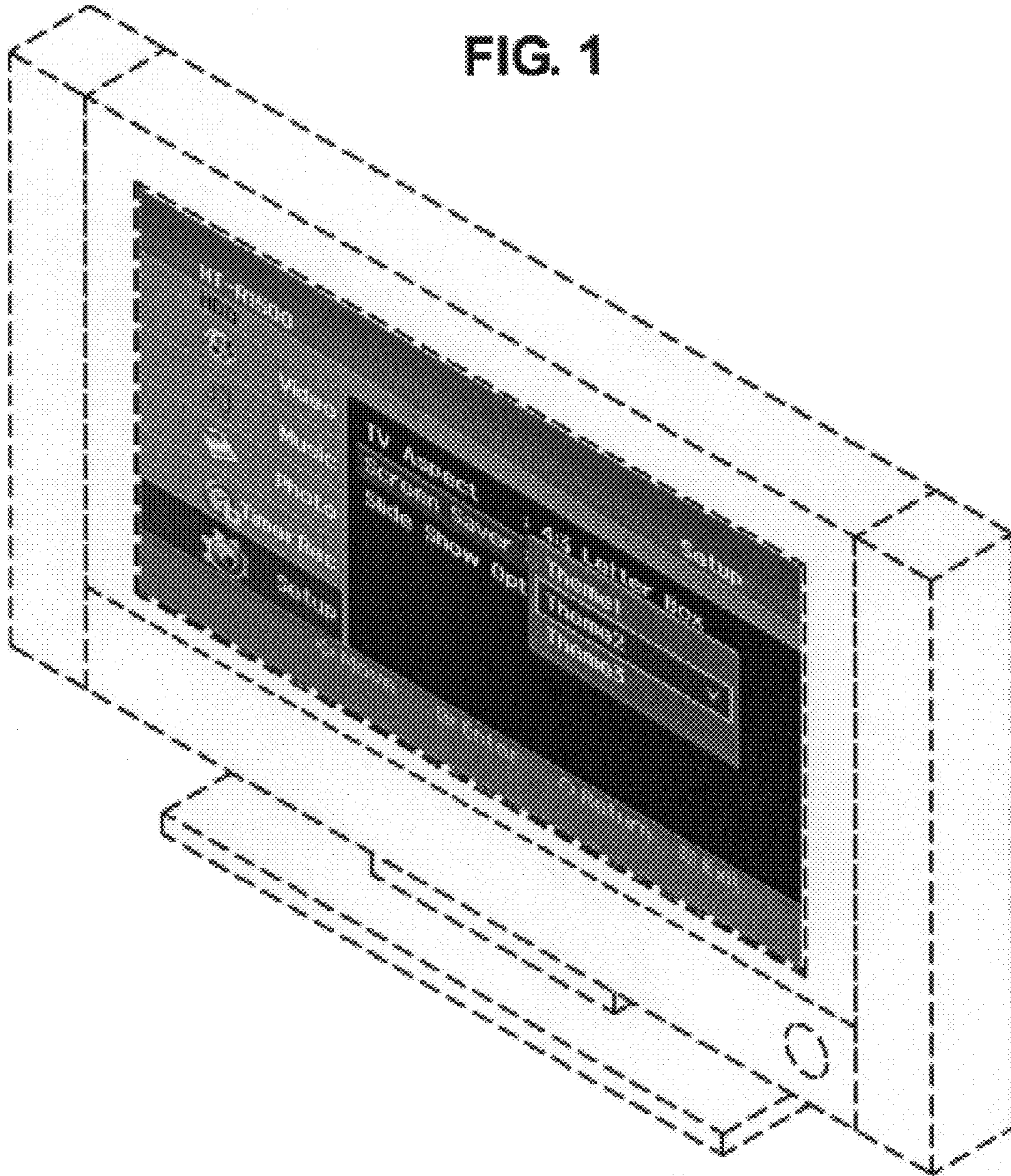

FIG. 2

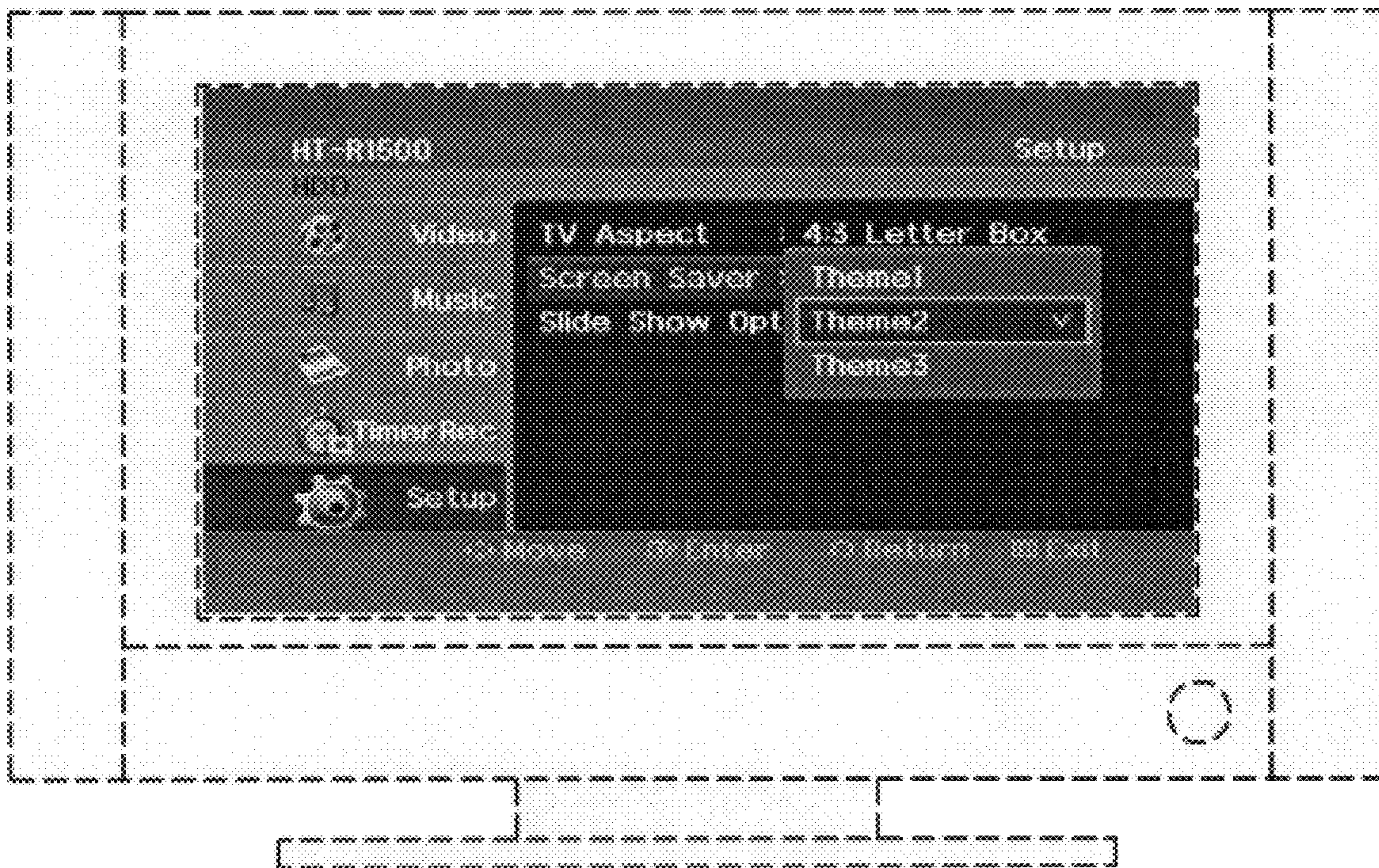

FIG. 3

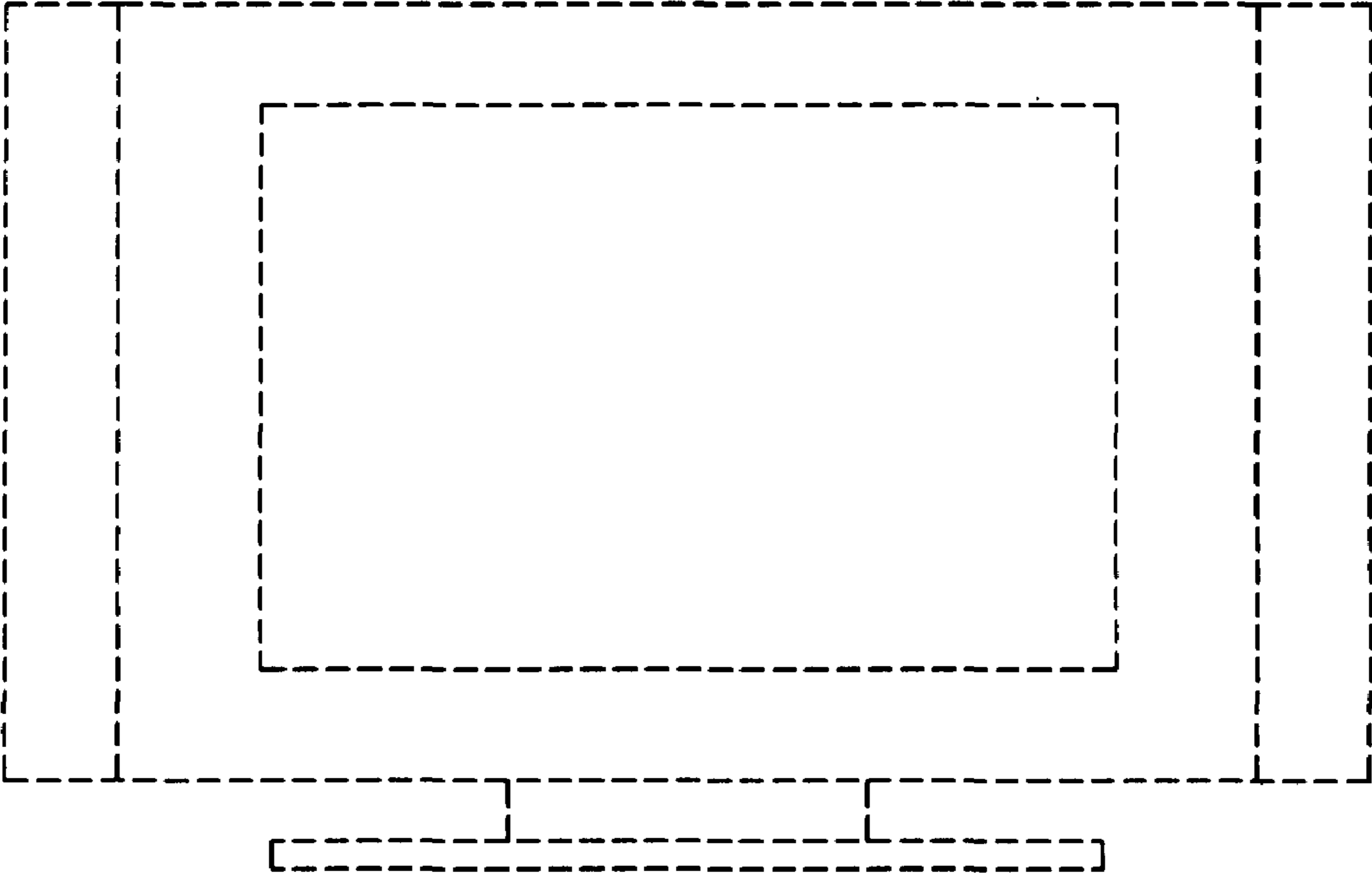

FIG. 4

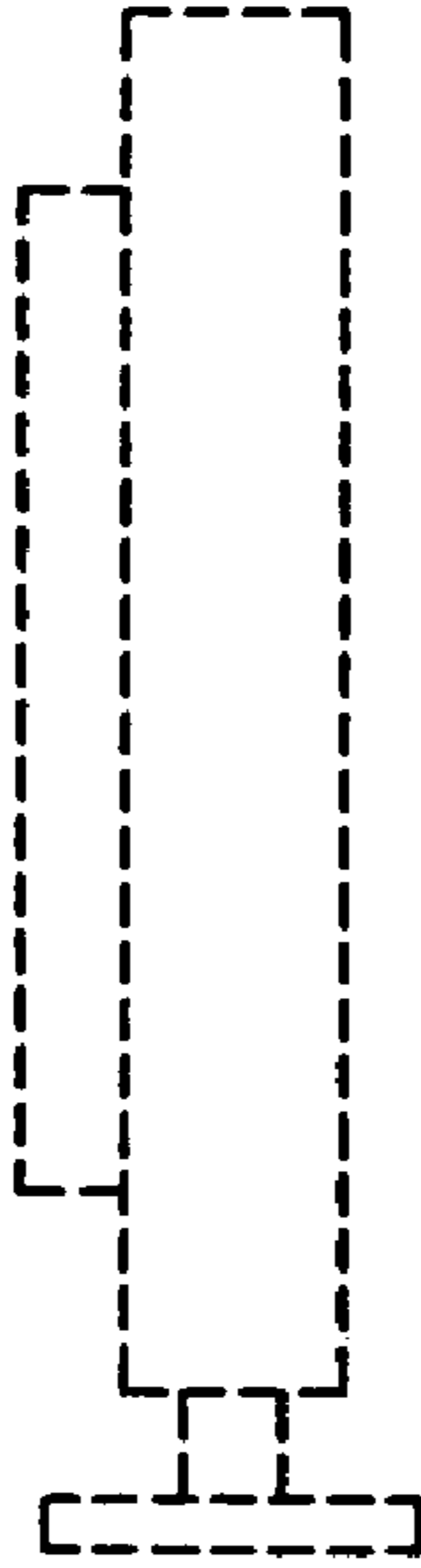

FIG. 5

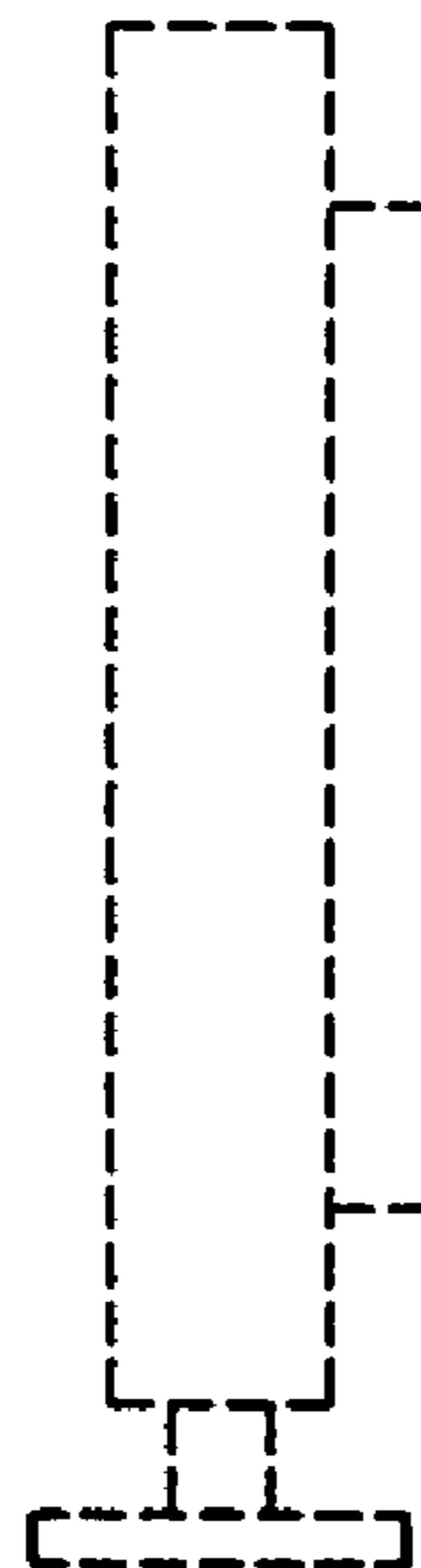

FIG. 6

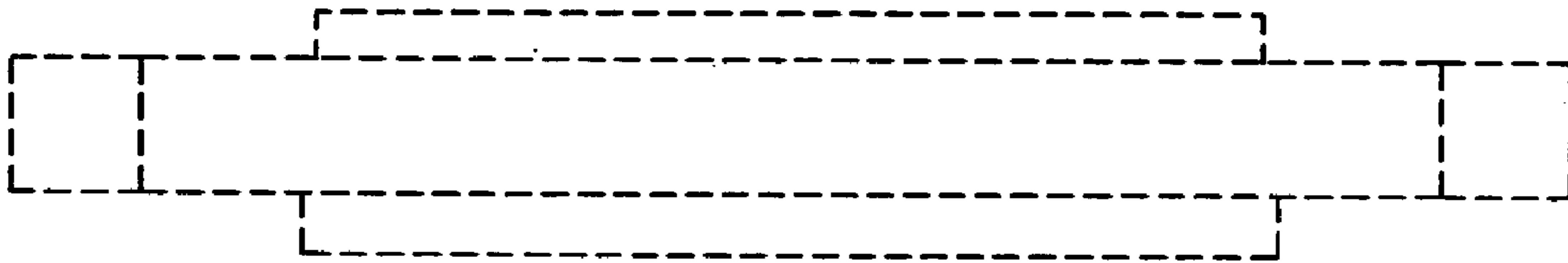

FIG. 7

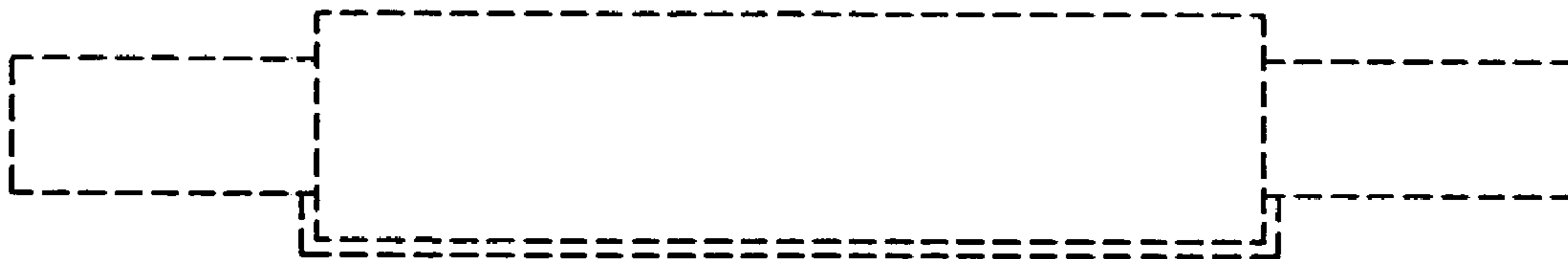

FIG. 8

