



US00D558179S

(12) **United States Design Patent**  
**Hansen**

(10) **Patent No.:** **US D558,179 S**

(45) **Date of Patent:** **\*\* Dec. 25, 2007**

(54) **MOBILE PHONE**

(75) Inventor: **Anders Hansen**, Lund (SE)

(73) Assignee: **Sony Ericsson Mobile Communications AB**, Lund (SE)

(\*\*) Term: **14 Years**

(21) Appl. No.: **29/277,421**

(22) Filed: **Feb. 26, 2007**

(30) **Foreign Application Priority Data**

Sep. 15, 2006 (EM) ..... 000588918

(51) **LOC (8) Cl.** ..... **14-03**

(52) **U.S. Cl.** ..... **D14/138**

(58) **Field of Classification Search** ..... D14/137-138,  
D14/147-148, 156, 218, 247-248, 341-347,  
D14/496; D16/208; D21/329, 331, 333,  
D21/517; 348/14.01-14.02; 361/814; 379/  
433.01-433.13; 455/90.3, 556.1-556.2,  
455/566, 575.1, 575.3, 575.4  
See application file for complete search history.

(56) **References Cited**

**U.S. PATENT DOCUMENTS**

D339,338 S *	9/1993	Tattari et al. ....	D14/138
D492,657 S *	7/2004	Jensfelt .....	D14/138
D496,642 S *	9/2004	Harries et al. ....	D14/138
D511,334 S *	11/2005	Winebrenner et al. ....	D14/138
D515,528 S *	2/2006	Miyazawa et al. ....	D14/138
D515,532 S *	2/2006	Shintani .....	D14/138
D515,533 S *	2/2006	Yano .....	D14/138
D515,543 S *	2/2006	Shintani .....	D14/138
D524,274 S *	7/2006	Choi et al. ....	D14/138
D538,252 S *	3/2007	Joung .....	D14/138
D539,778 S *	4/2007	Yeh et al. ....	D14/138

D540,773 S *	4/2007	Meng et al. ....	D14/138
D545,800 S *	7/2007	Ou et al. ....	D14/138
D546,314 S *	7/2007	Im .....	D14/138
D546,801 S *	7/2007	Jung .....	D14/138
2004/0185912 A1 *	9/2004	Mason et al. ....	455/566

**OTHER PUBLICATIONS**

Philips 768, announced 4Q 2005, <URL:http://www.gsmarena.com/philips\_768-1386.php>, retrieved from internet on Aug. 31, 2007.\*  
Sony Ericsson F500i, announced 2Q 2004, <URL:http://www.gsmarena.com/sony\_ericsson\_f500i-828.php>, retrieved from internet on Aug. 31, 2007.\*

Nokia 6030, announced 1Q 2005, <URL:http://www.gsmarena.com/nokia\_6030-1086.php>, retrieved from internet on Aug. 31, 2007.\*

\* cited by examiner

*Primary Examiner*—Ian Simmons

*Assistant Examiner*—Carla Jobe Wright

(74) *Attorney, Agent, or Firm*—Renner, Otto, Boisselle & Sklar, LLP

(57) **CLAIM**

The ornamental design for a mobile phone, as shown and described.

**DESCRIPTION**

FIG. 1 is a perspective view of a mobile phone showing my design;

FIG. 2 is a front view thereof;

FIG. 3 is a rear view thereof;

FIG. 4 is a left side view thereof;

FIG. 5 is a right side view thereof;

FIG. 6 is a top view thereof; and,

FIG. 7 is a bottom view thereof.

**1 Claim, 5 Drawing Sheets**

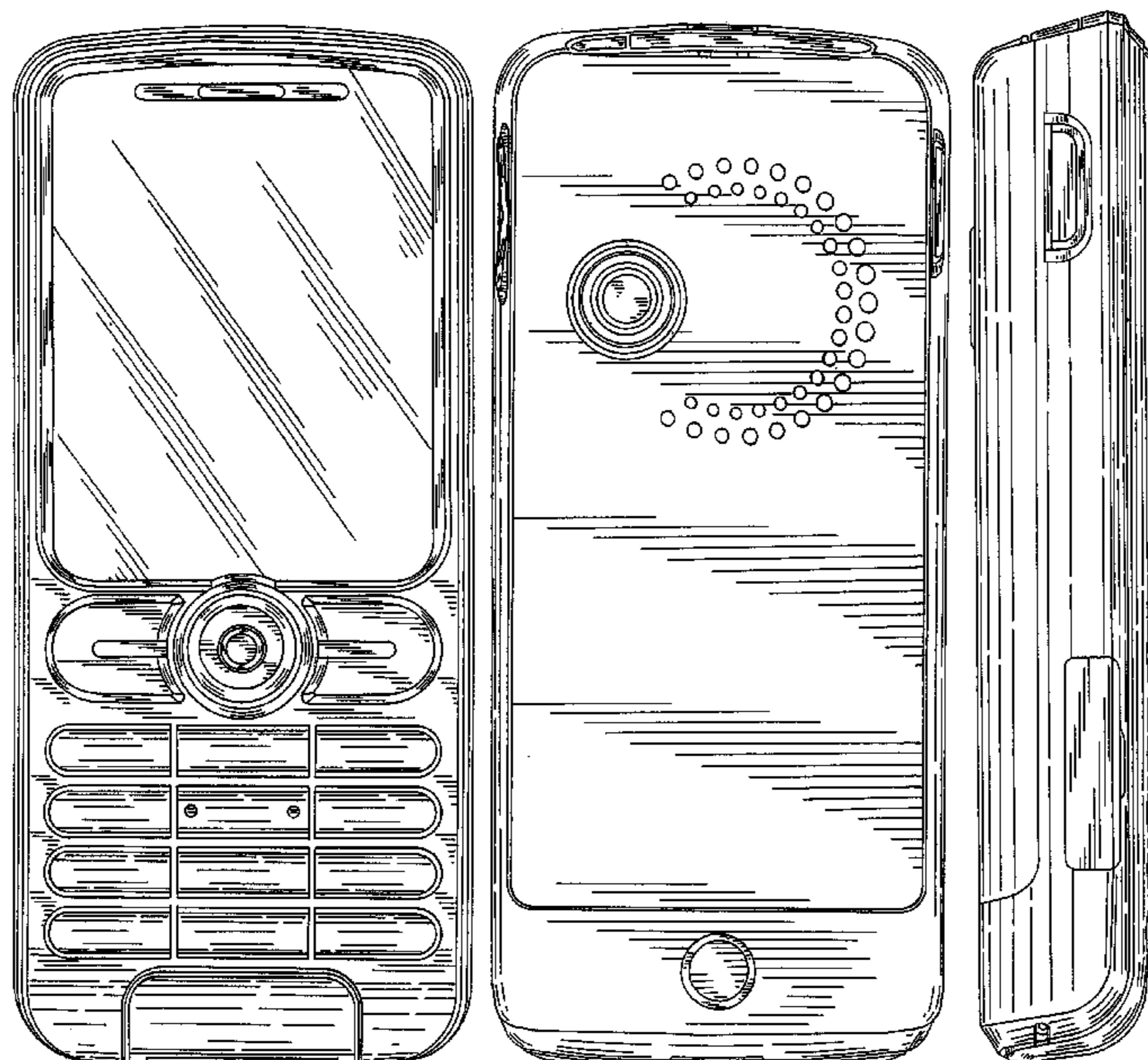

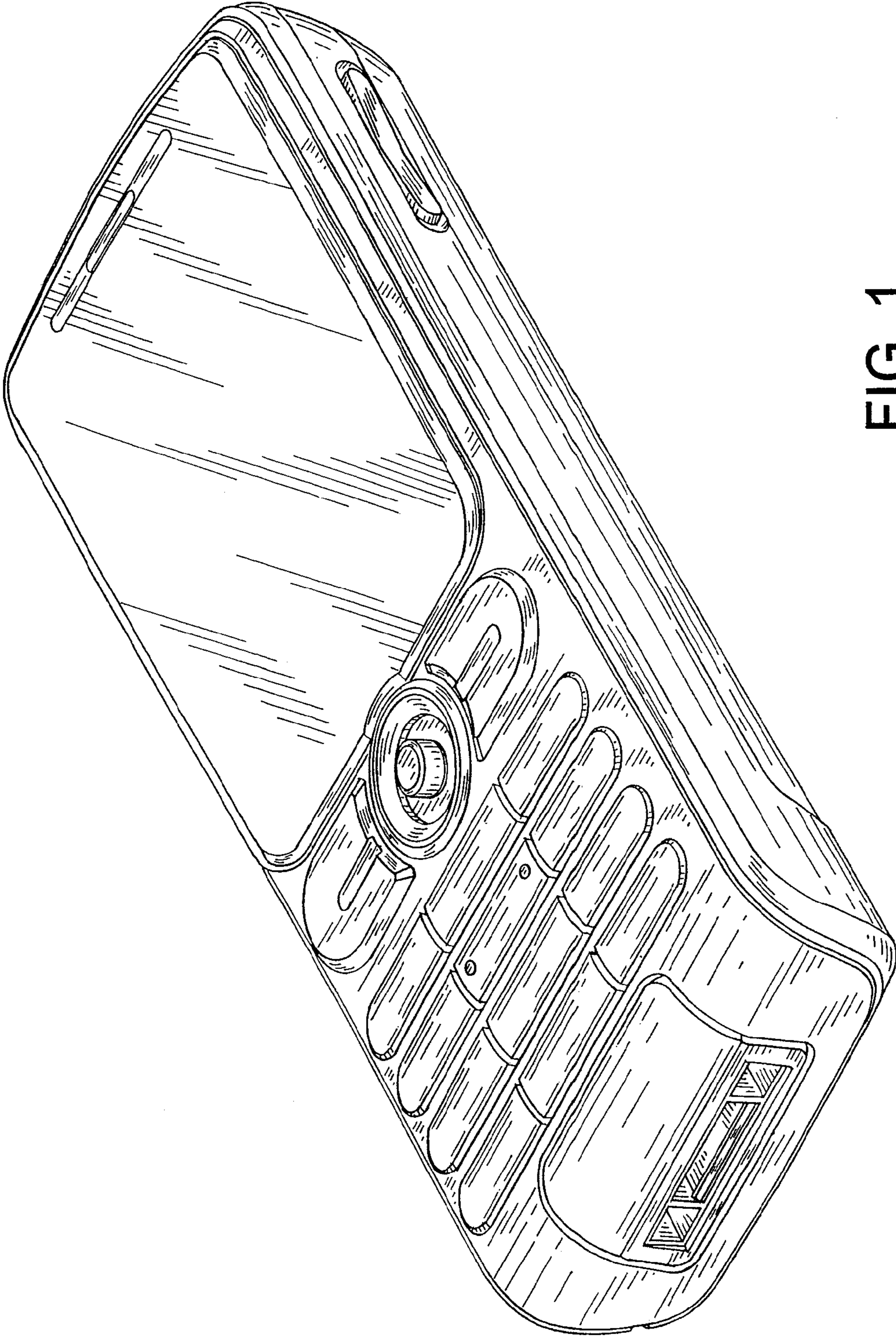

FIG. 1



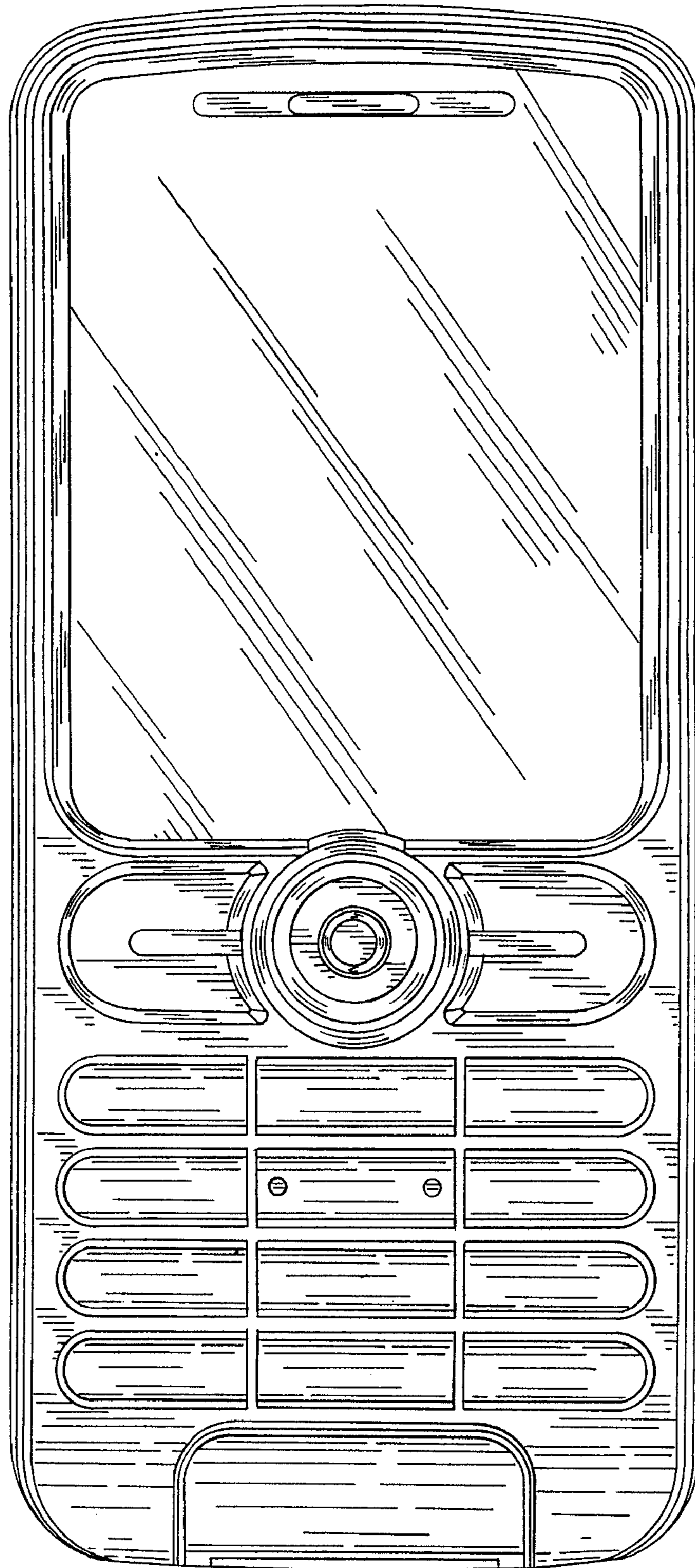

FIG. 2

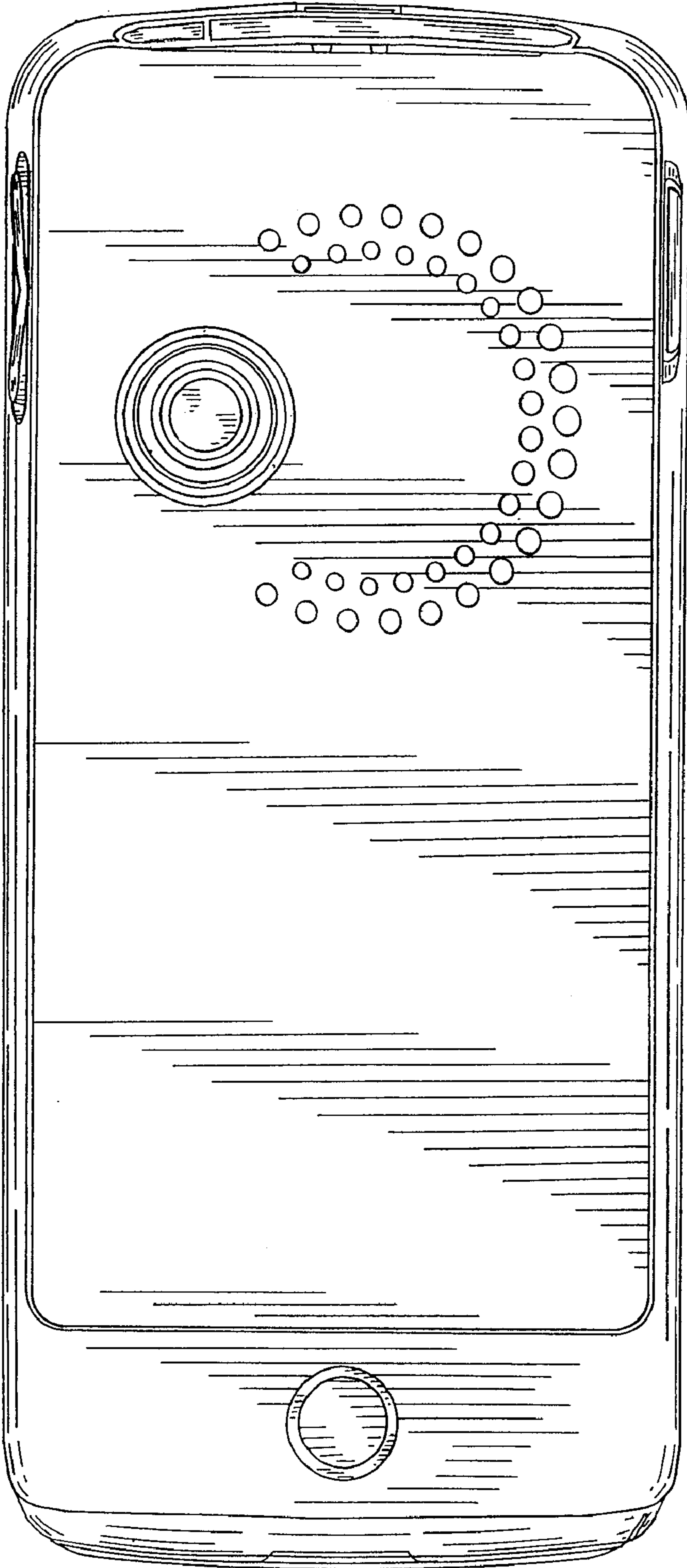

FIG. 3

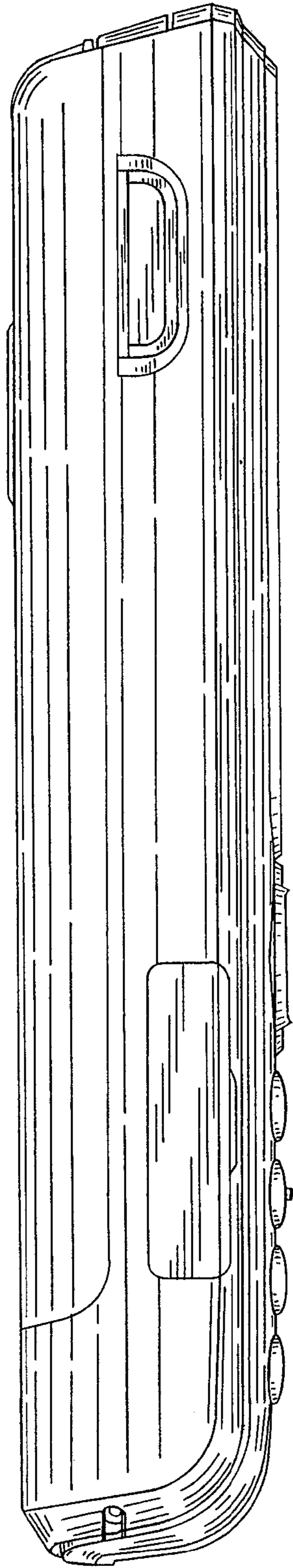

FIG. 4

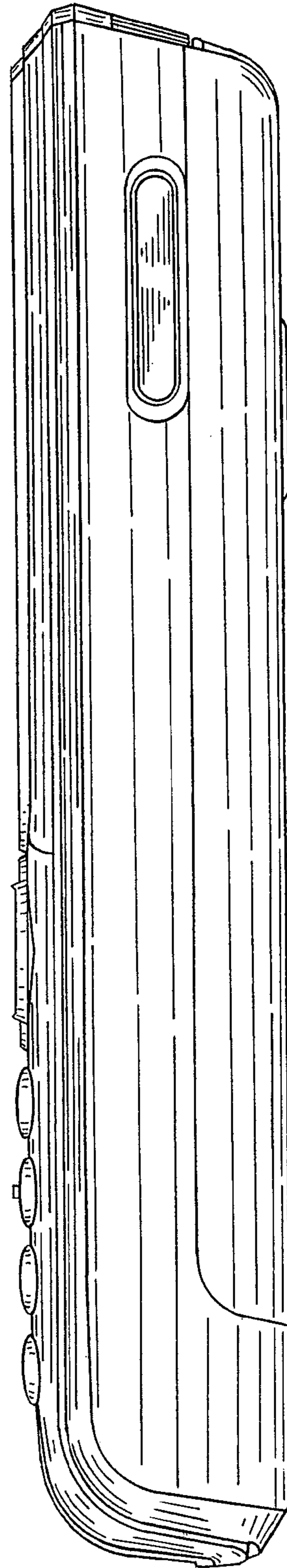

FIG. 5

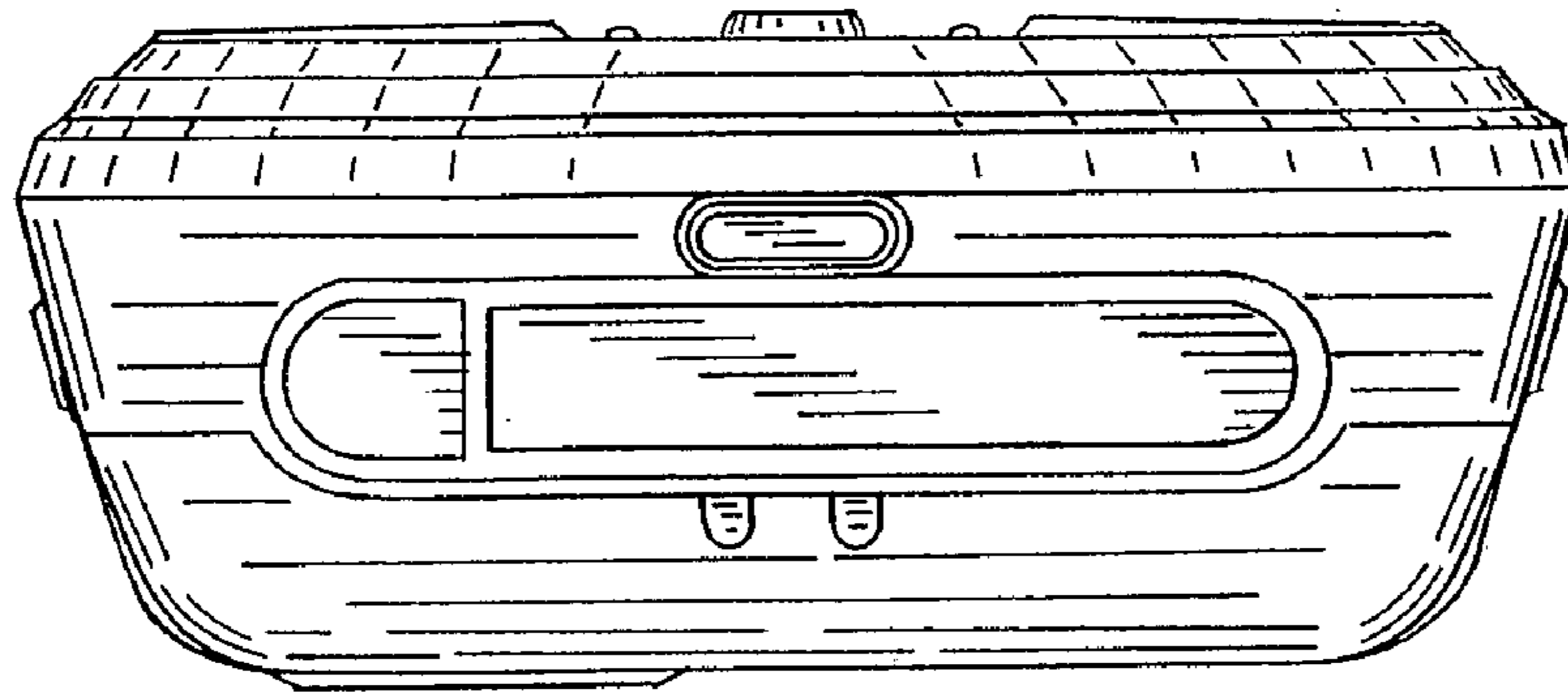

FIG. 6

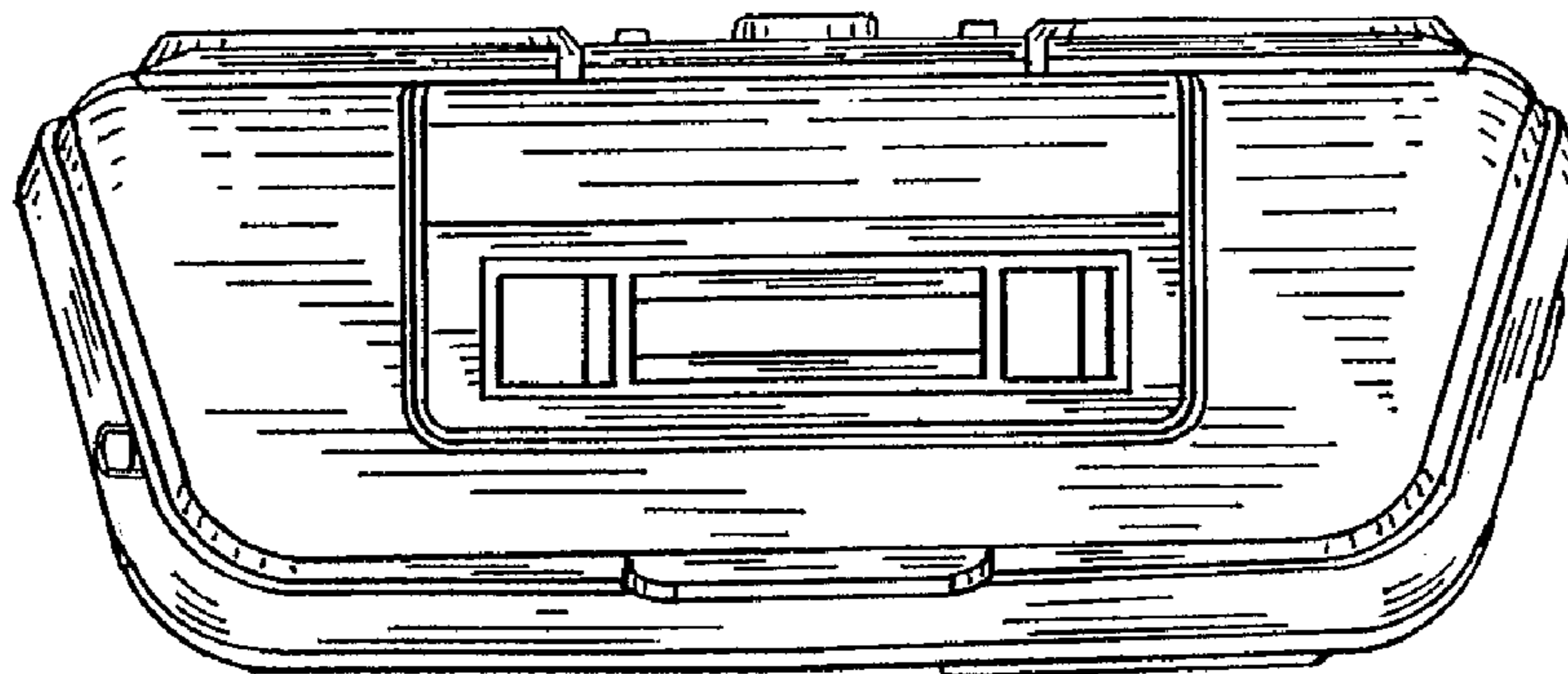

FIG. 7