



US00D558098S

(12) **United States Design Patent**
Giner

(10) **Patent No.:** **US D558,098 S**

(45) **Date of Patent:** **** Dec. 25, 2007**

(54) **TRAILER UNIT**

(75) Inventor: **Rafael Ibanez Giner**, Barcelona (ES)

(73) Assignee: **Thermo King Corporation**,
Minneapolis, MN (US)

(**) Term: **14 Years**

(21) Appl. No.: **29/247,826**

(22) Filed: **Jul. 14, 2006**

(51) **LOC (8) Cl.** **12-10**

(52) **U.S. Cl.** **D12/106**

(58) **Field of Classification Search** D12/102-103,
D12/101, 106, 90, 114, 93, 196, 95-100,
D12/82, 86; 280/656; D34/12; 180/89.1;
296/156, 168, 181.1, 182.1; D25/138
See application file for complete search history.

(56) **References Cited**

U.S. PATENT DOCUMENTS

D176,285 S *	12/1955	Raker	D12/106
D179,559 S *	1/1957	Chisholm	D12/97
D182,288 S *	3/1958	Peter	D12/103
D182,505 S *	4/1958	Deckrow	D12/106
D235,534 S *	6/1975	May	D12/103
D320,051 S *	9/1991	Phillips	D21/506
D328,728 S *	8/1992	Shea, Sr.	D12/103
D355,398 S *	2/1995	Shea, Sr.	D12/106
D408,333 S *	4/1999	Prusmack	D12/101
D469,388 S *	1/2003	Mighell	D12/101

D510,299 S *	10/2005	Gunby	D12/82
D515,466 S *	2/2006	Gunby	D12/103
D543,902 S *	6/2007	Kelly	D12/103

* cited by examiner

Primary Examiner—Lucy Lieberman

Assistant Examiner—Abraham Bahta

(74) *Attorney, Agent, or Firm*—Michael Best & Friedrich LLP

(57) **CLAIM**

The ornamental design for a trailer unit, as shown and described.

DESCRIPTION

FIG. 1 is a front perspective view of a trailer unit showing my new invention;

FIG. 2 is a front view of the trailer unit of FIG. 1.

FIG. 3 is a rear view of the trailer unit of FIG. 1.

FIG. 4 is a left side view of the trailer unit of FIG. 1.

FIG. 5 is a right side view of the trailer unit of FIG. 1.

FIG. 6 is a top view of the trailer unit of FIG. 1; and,

FIG. 7 is a bottom view of the trailer unit of FIG. 1.

The broken line showing of the environment is for illustrative purposes only and forms no part of the claimed design. The broken lines which define the boundaries of the claimed design form no part thereof.

1 Claim, 5 Drawing Sheets

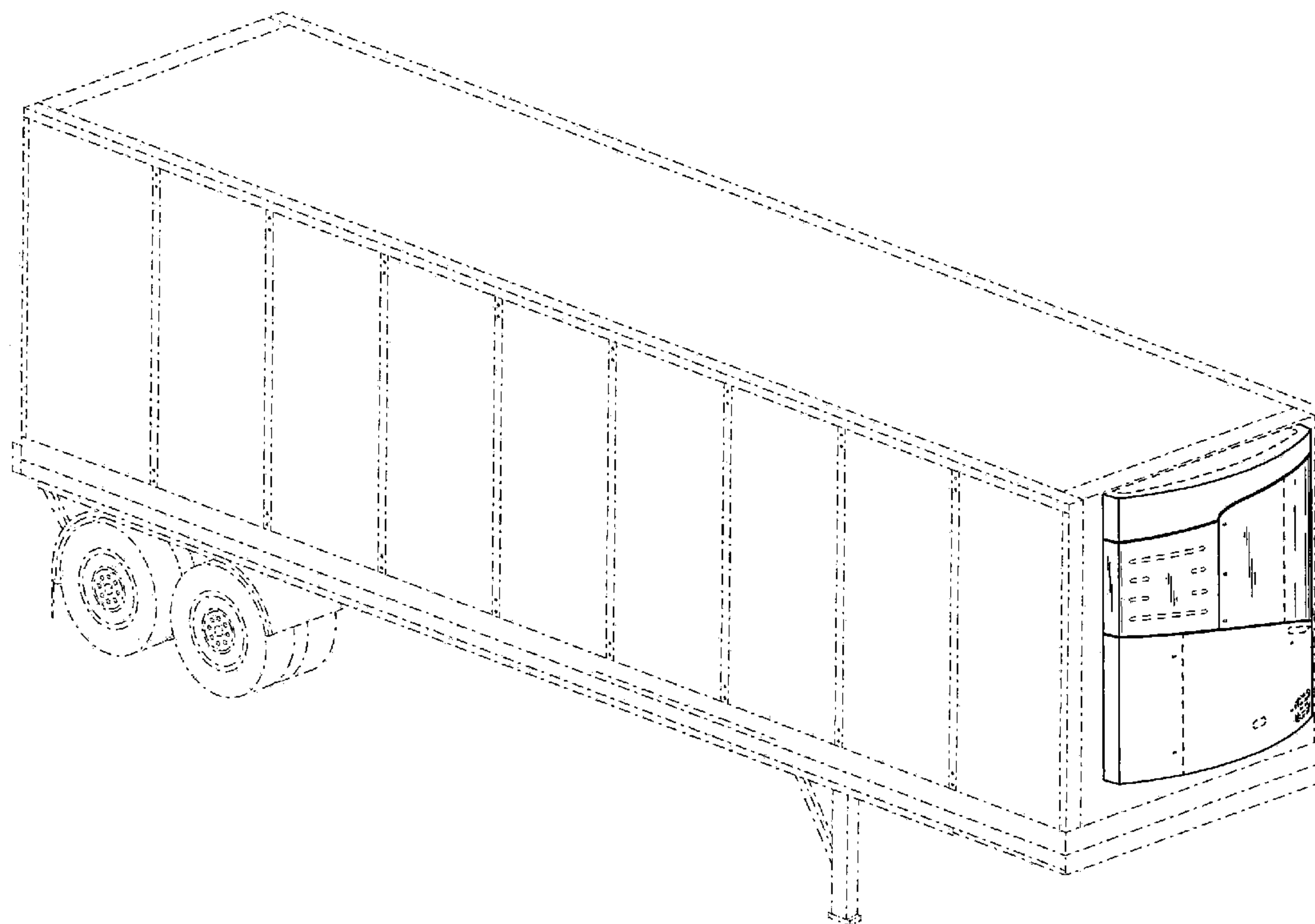

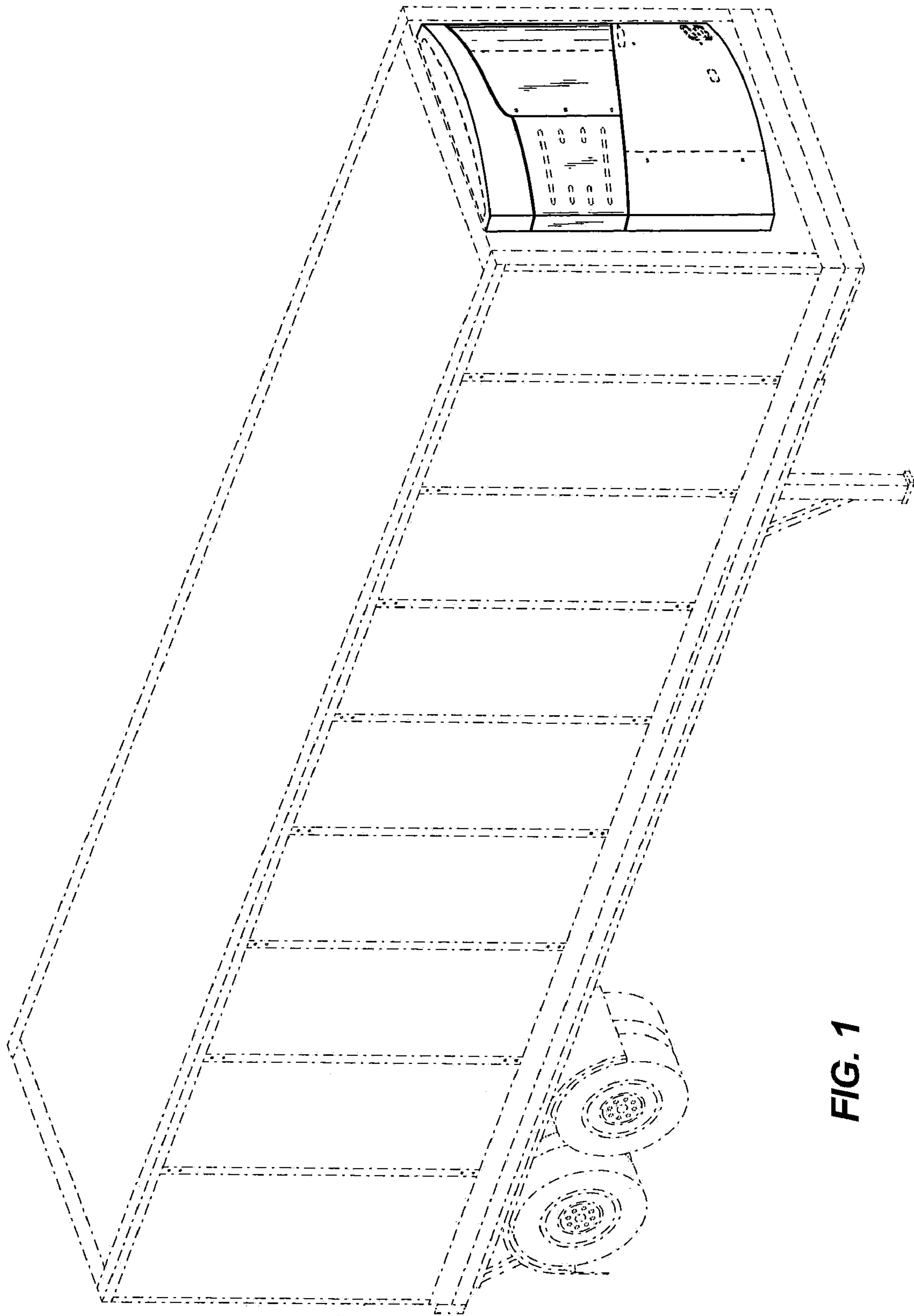

FIG. 1

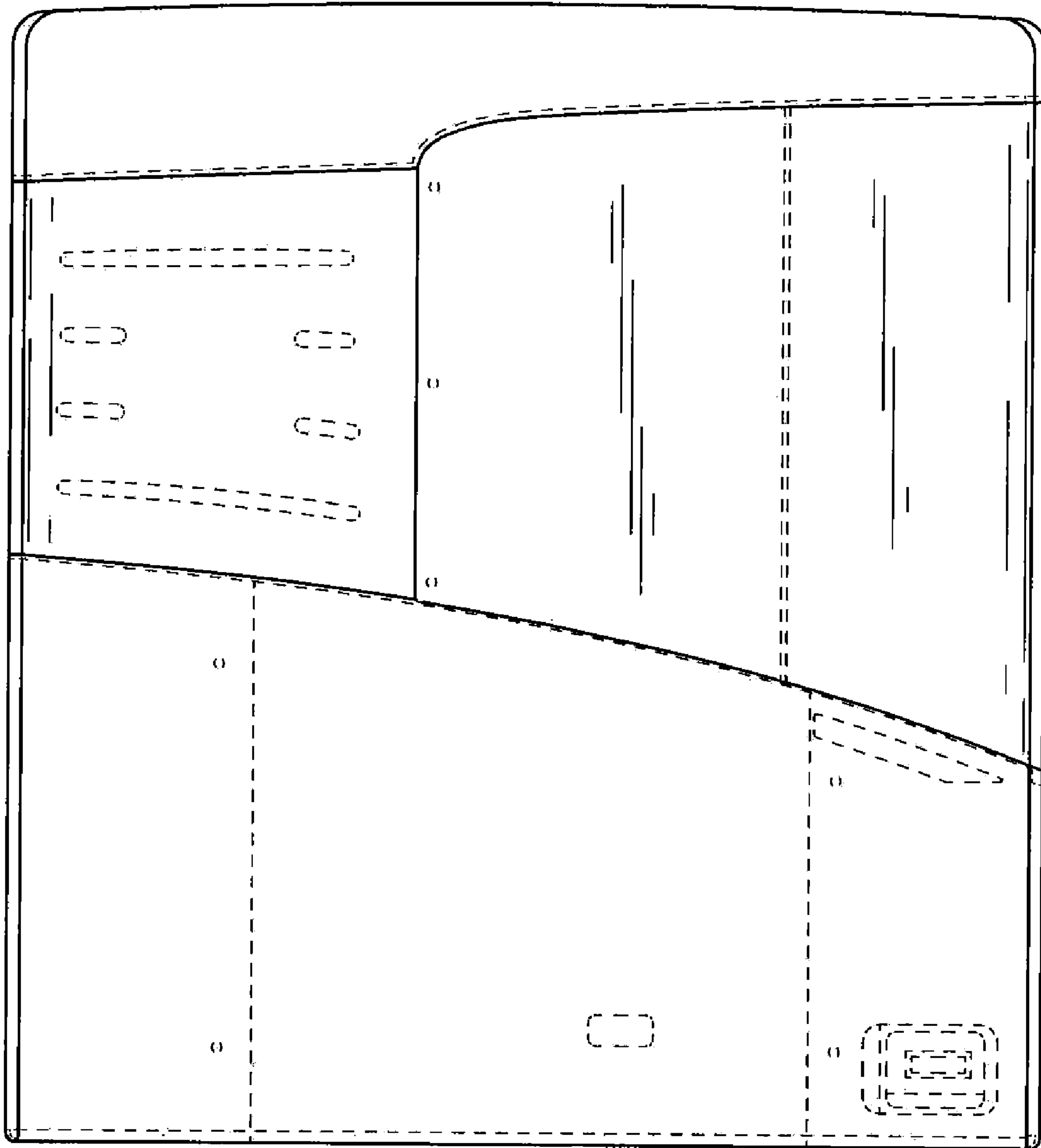

FIG. 2

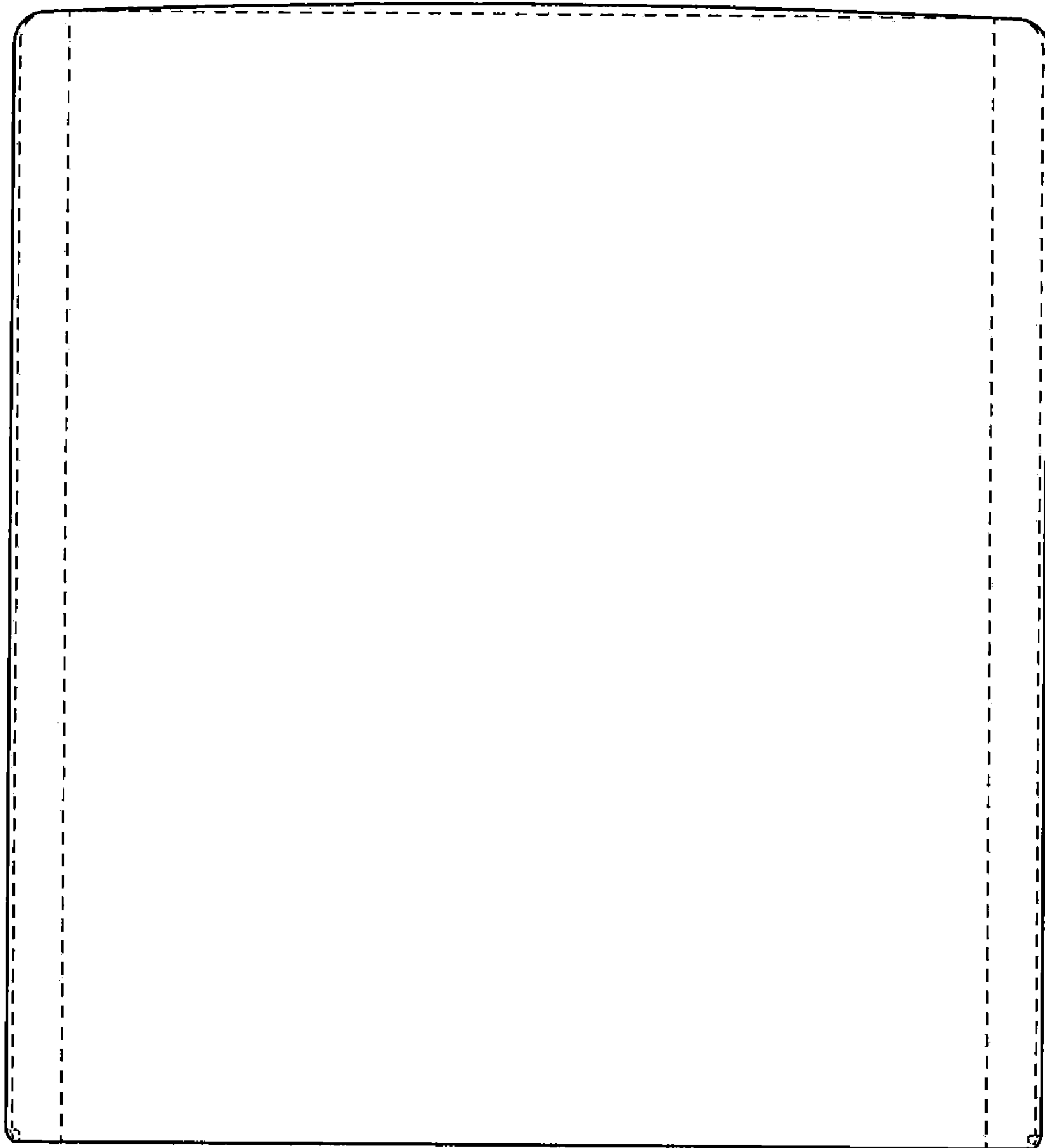

FIG. 3

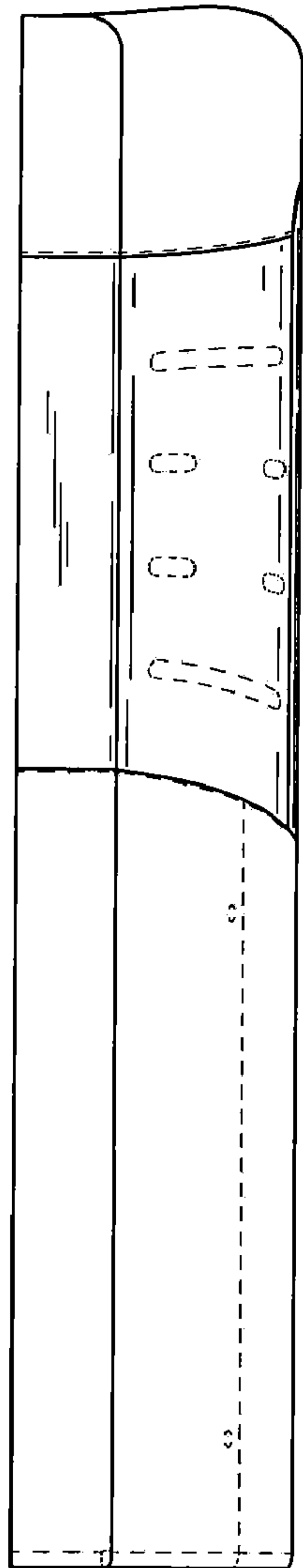

FIG. 4

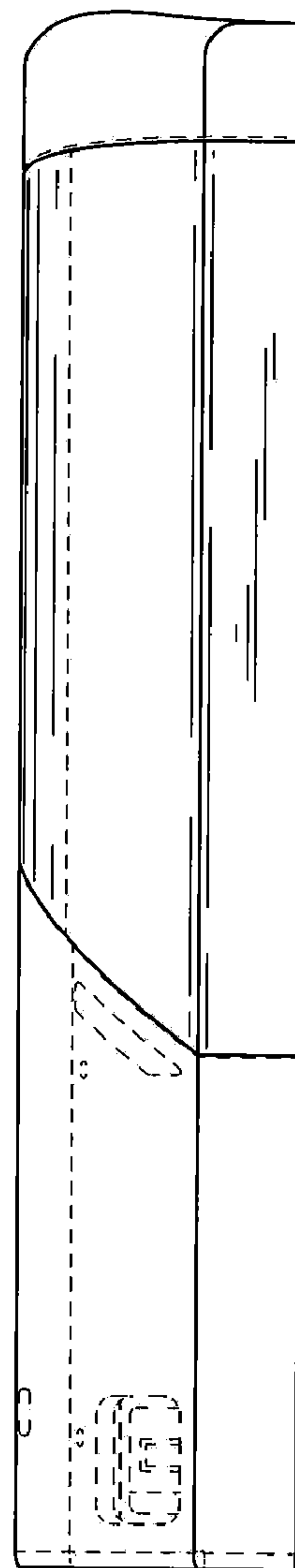

FIG. 5

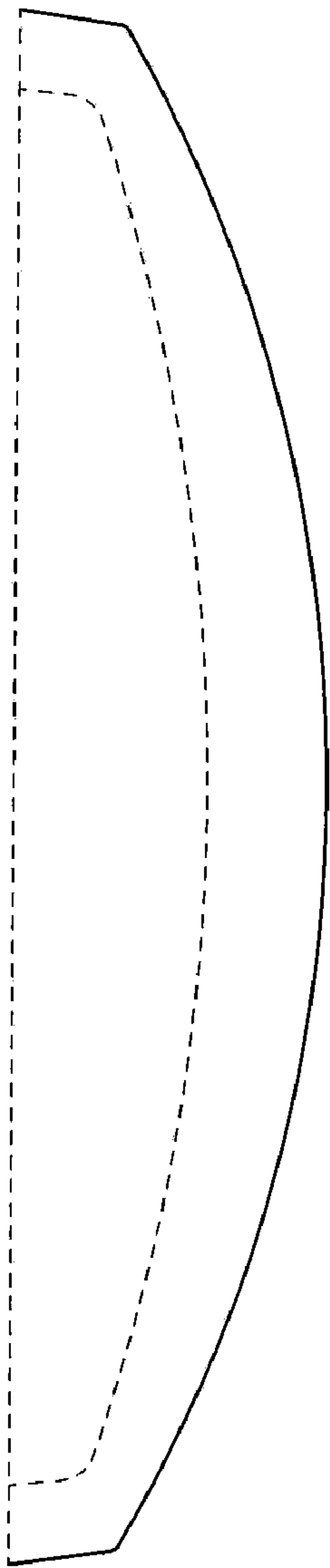

FIG. 6

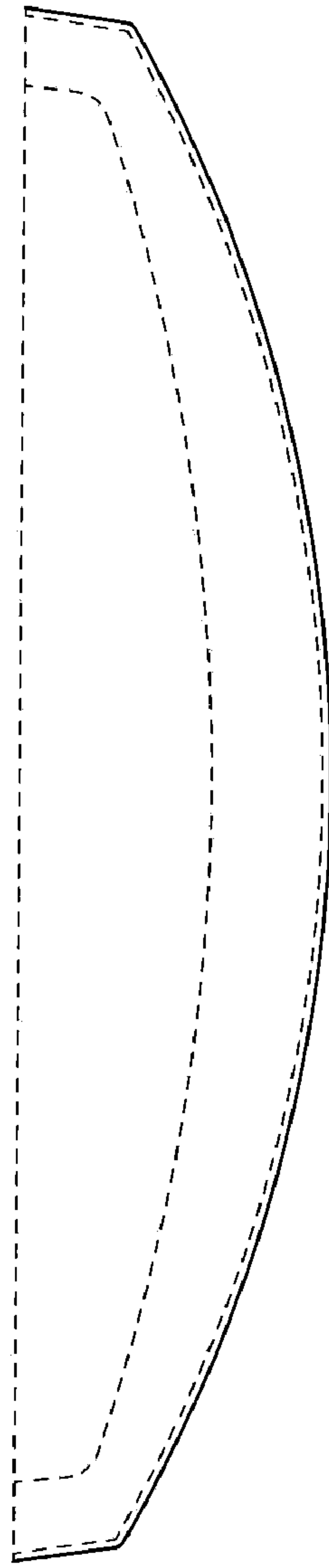

FIG. 7