



US00D557912S

(12) **United States Design Patent**
Mourgue

(10) **Patent No.:** **US D557,912 S**

(45) **Date of Patent:** **** *Dec. 25, 2007**

(54) **SEAT**

(75) Inventor: **Pascal Mourgue**, Montreuil Sous Bois (FR)

(73) Assignee: **Cinna** (FR)

(*) Notice: This patent is subject to a terminal disclaimer.

(**) Term: **14 Years**

(21) Appl. No.: **29/263,168**

(22) Filed: **Jul. 18, 2006**

(30) **Foreign Application Priority Data**

Jan. 18, 2006 (EP) 000469895-0006

(51) **LOC (8) Cl.** **06-01**

(52) **U.S. Cl.** **D6/361**

(58) **Field of Classification Search** D6/367-369,
D6/360-361, 374, 382, 364, 365, 375, 500-502;
297/353, 118, 354.1, 423.1, 452.12, 284.1;
5/12.1, 656, 657, 620-622

See application file for complete search history.

(56) **References Cited**

U.S. PATENT DOCUMENTS

D120,131 S *	4/1940	Moeller	D6/335
D183,790 S *	10/1958	Deaton	D6/361
D217,449 S *	5/1970	Meyer	D6/361
D228,428 S *	9/1973	Wilson	D6/361
D387,211 S *	12/1997	Mourgue	D6/361
D398,454 S *	9/1998	Desombre	D6/360
D490,618 S *	6/2004	Green et al.	D6/361
D504,244 S *	4/2005	Mourgue	D6/361

D509,079 S *	9/2005	Natuzzi	D6/361
D530,933 S *	10/2006	Vitaro	D6/361
D531,828 S *	11/2006	Frinier	D6/361
D533,368 S *	12/2006	Natuzzi	D6/361
D533,727 S *	12/2006	Frinier	D6/361

* cited by examiner

Primary Examiner—Caron D. Veynar

Assistant Examiner—Abraham Bahta

(74) *Attorney, Agent, or Firm*—Cantor Colburn LLP

(57) **CLAIM**

I claim, the ornamental design for a seat, as shown and described.

DESCRIPTION

FIG. 1 is a front perspective view of a seat, showing my new design, with an exemplary pillow shown in broken lines for illustrative purposes only and forming no part of the claimed design;

FIG. 2 is a rear perspective view thereof;

FIG. 3 is a side view thereof, the opposite side being a mirror image thereof;

FIG. 4 is a front view thereof;

FIG. 5 is a rear view thereof;

FIG. 6 is a top view thereof shown without the exemplary pillow;

FIG. 7 is a bottom view thereof;

FIG. 8 is a perspective view thereof showing the seat in an alternate configuration without the exemplar pillow; and,

FIG. 9 is a side view thereof, the opposite side being a mirror image thereof.

1 Claim, 5 Drawing Sheets

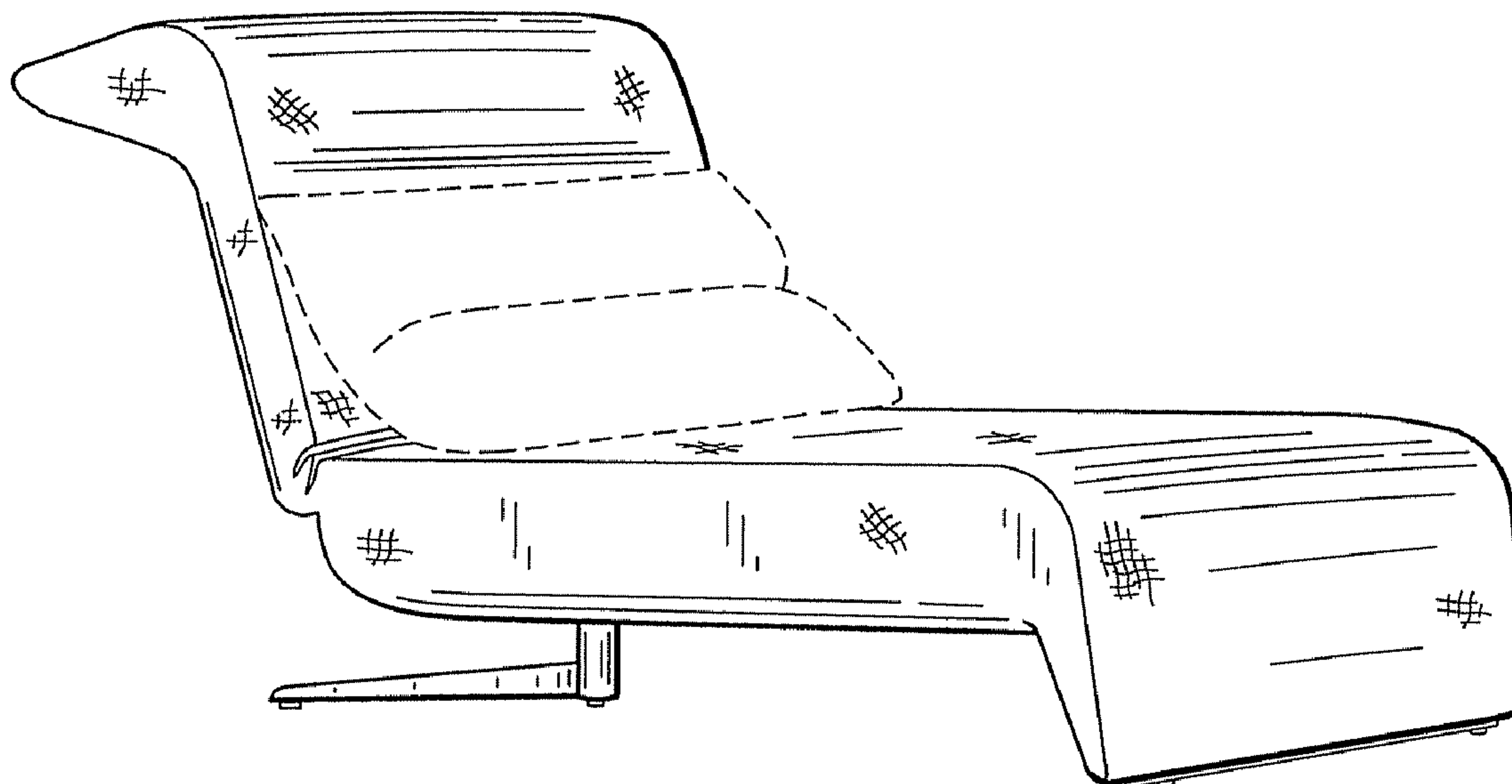

FIG. 1

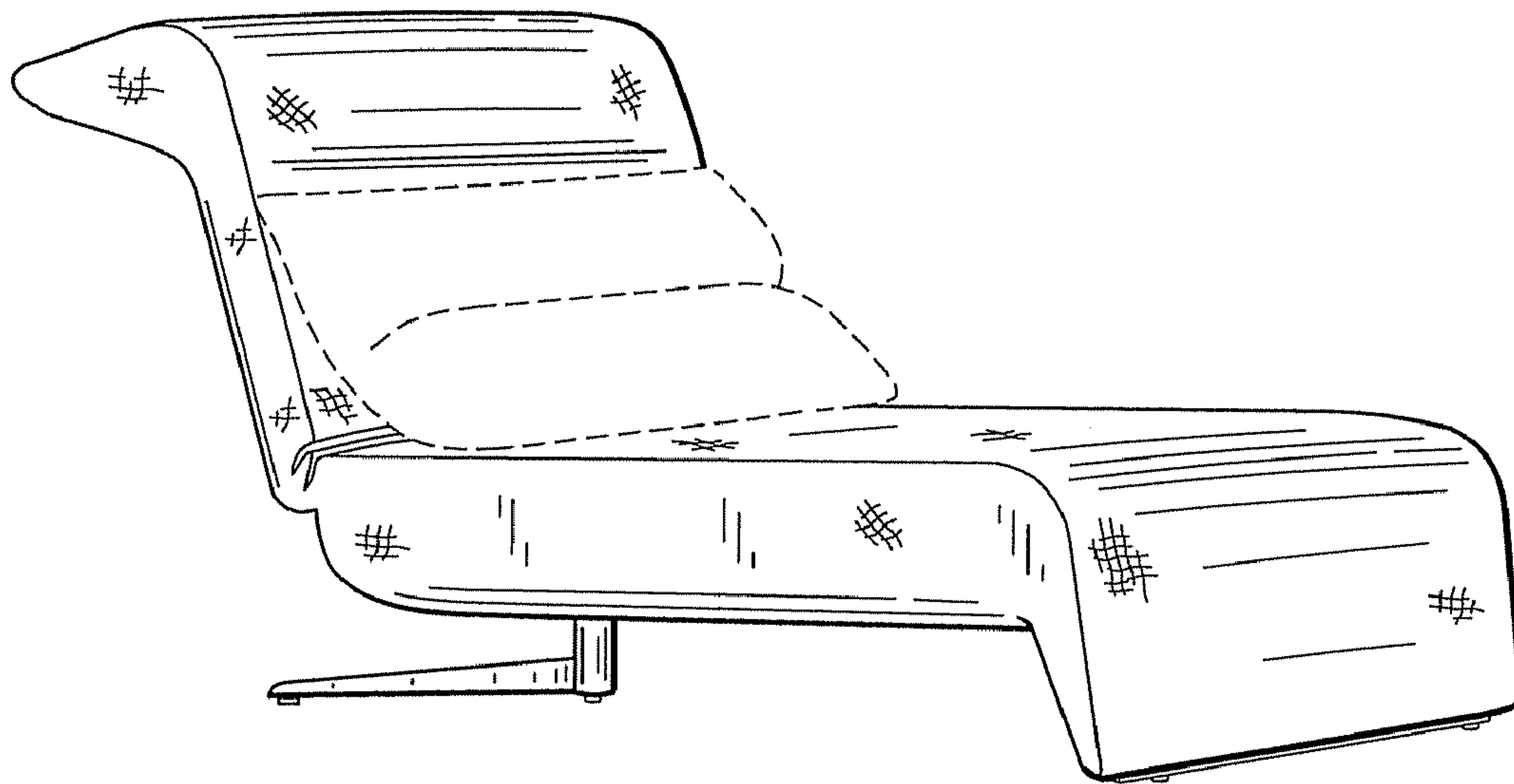

FIG. 2

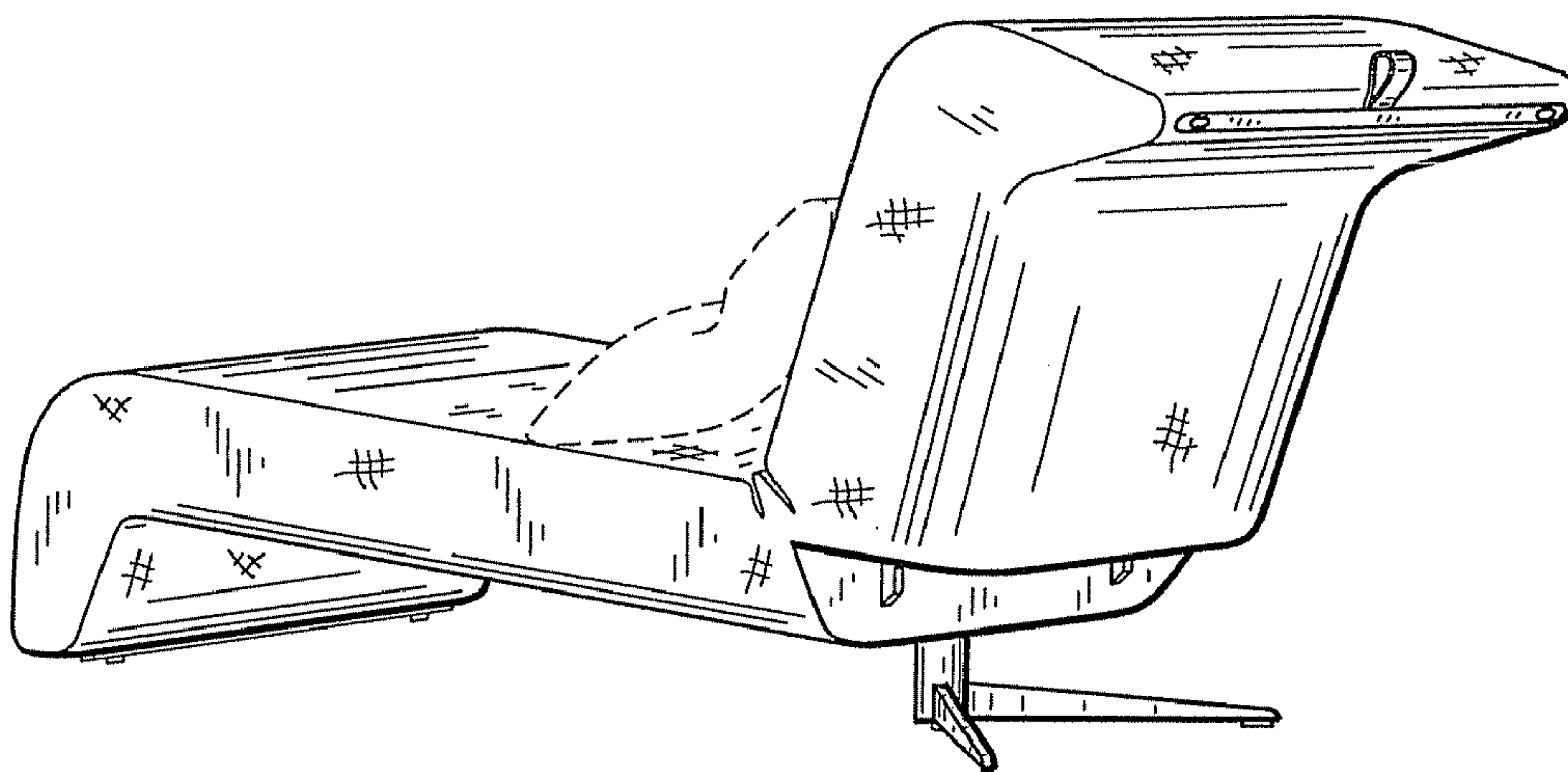

FIG. 3

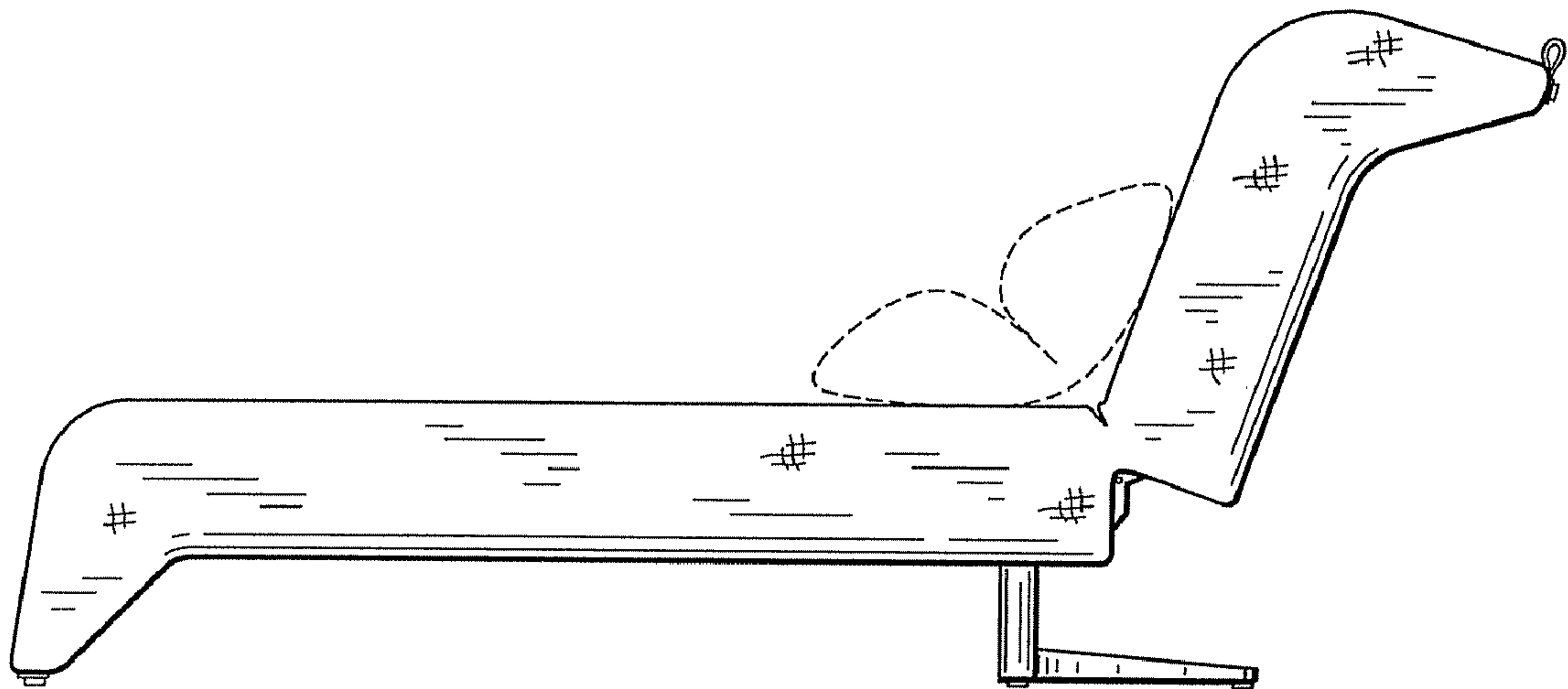

FIG. 4

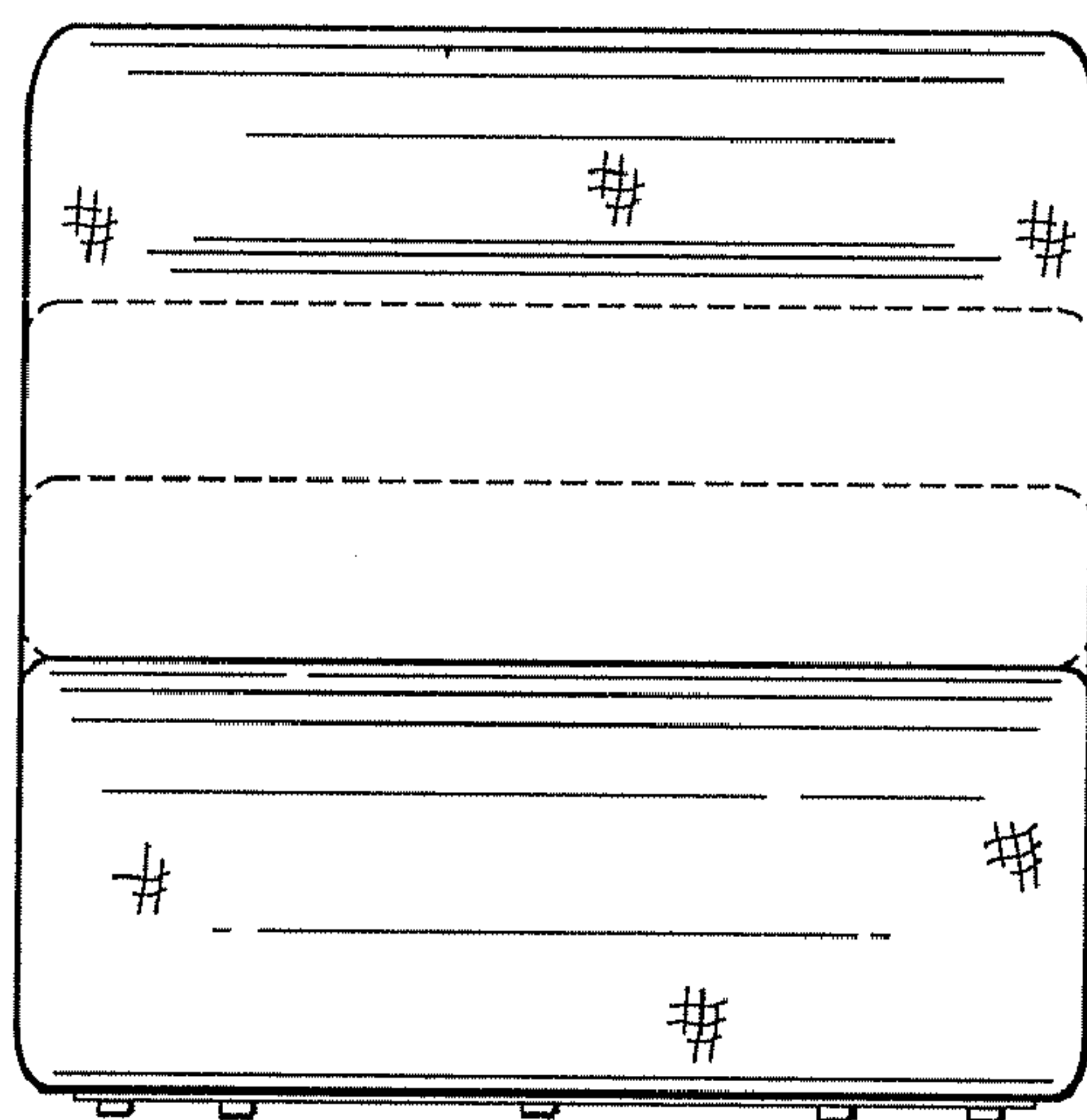

FIG. 5

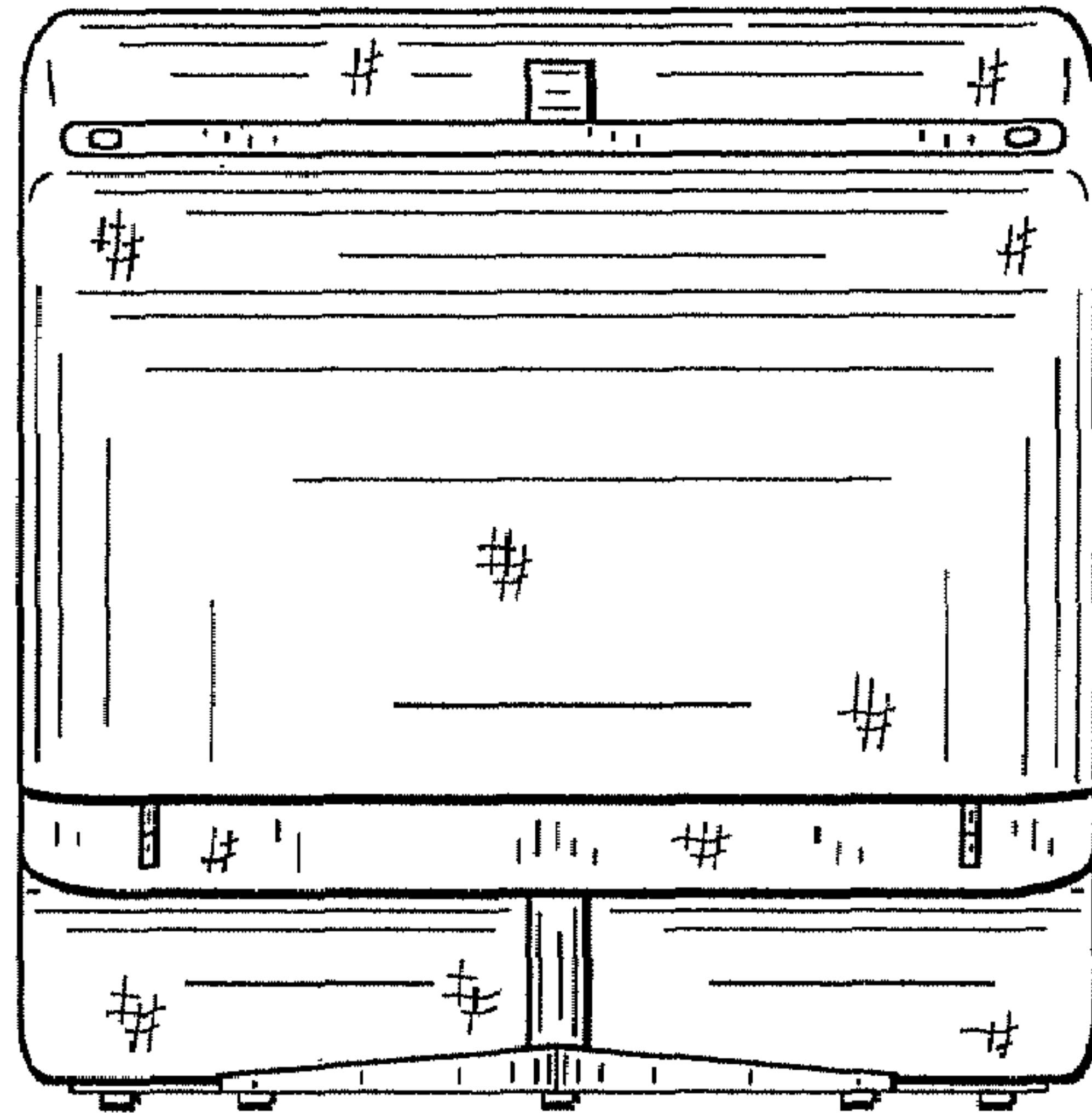

FIG. 6

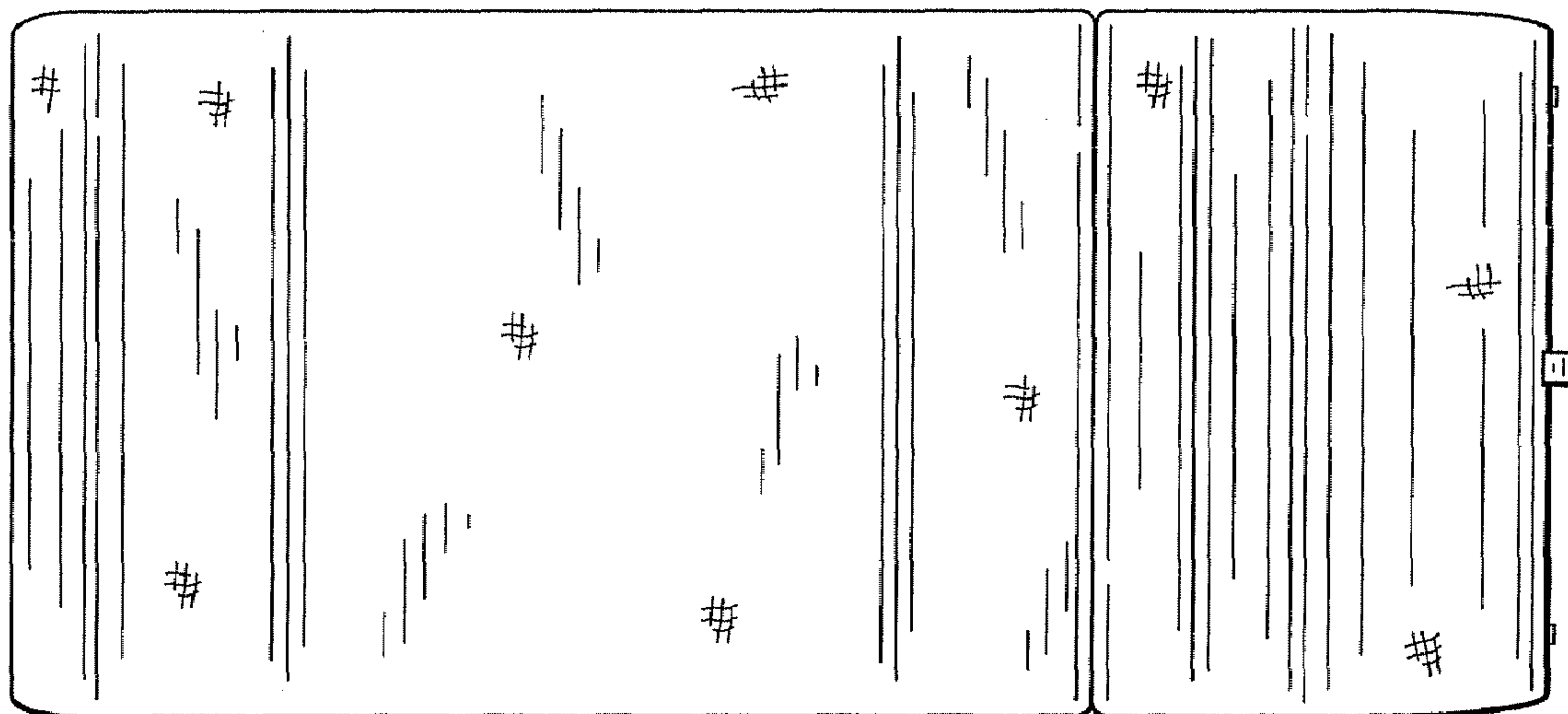

FIG. 7

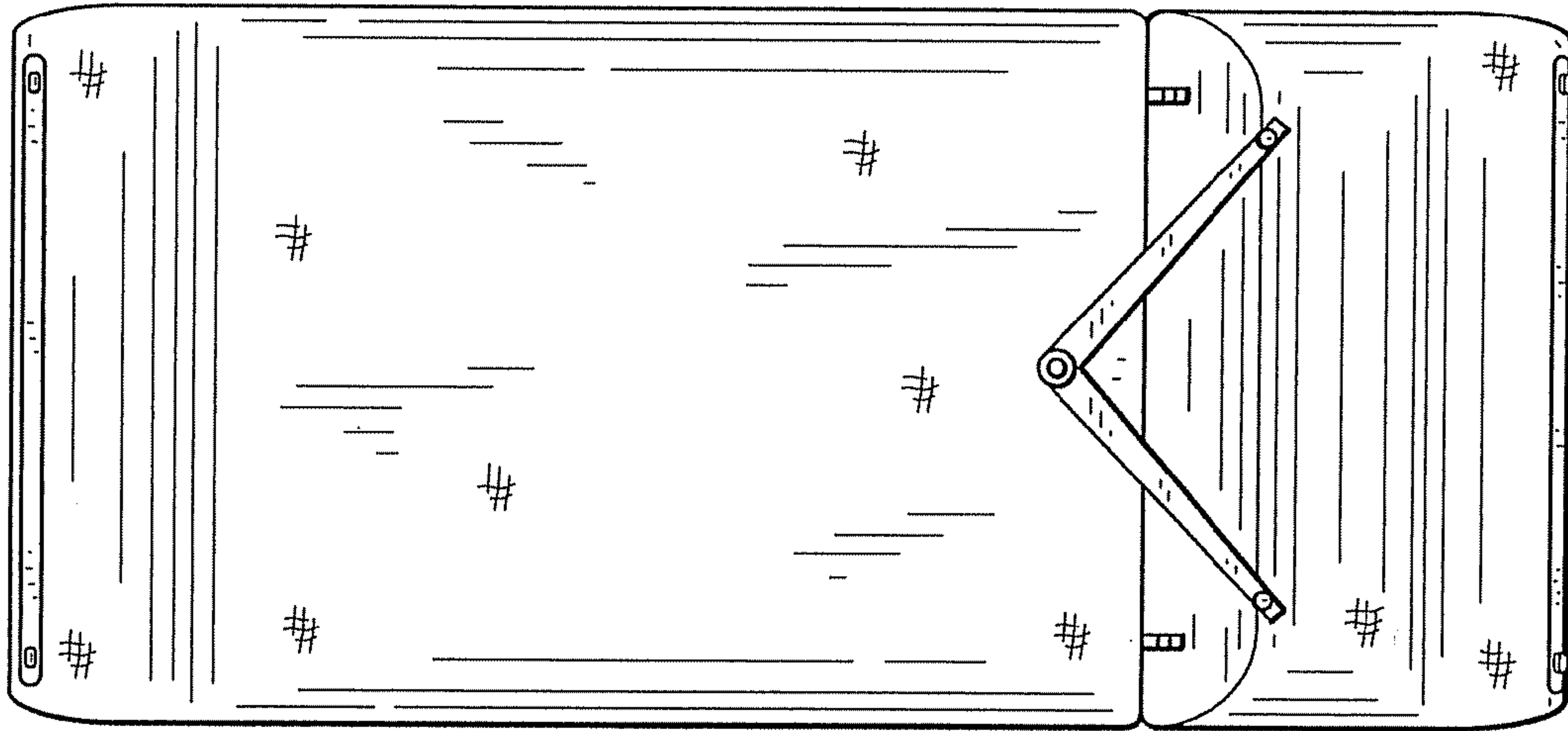

FIG. 8

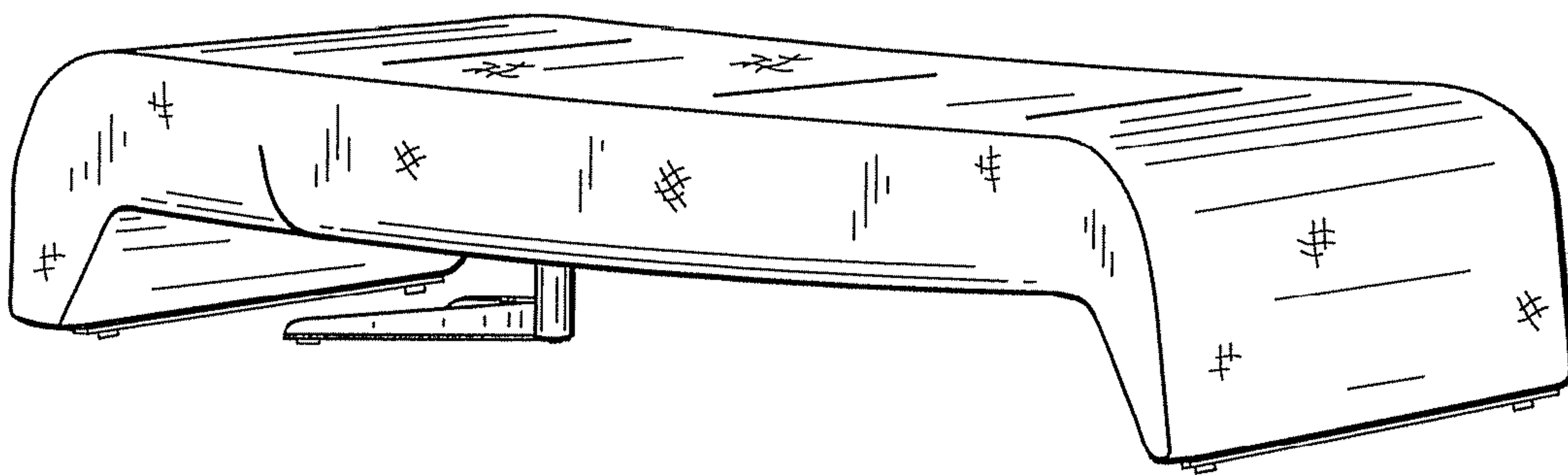

FIG. 9

