



US00D557797S

(12) **United States Design Patent** (10) **Patent No.:** **US D557,797 S**
Stawski et al. (45) **Date of Patent:** **** *Dec. 18, 2007**

(54) **CIRCULAR TABLET**

(75) Inventors: **Barbara Z. Stawski**, Forest Park, IL (US); **Thomas M. Mindak**, Itasca, IL (US); **Ingo C. Theurer**, München (DE); **Philip Mark Soukup**, Freiburg (DE); **Stefan Johannes Brehm**, Kolbermoor (DE)

(73) Assignee: **Wm. Wrigley Jr. Company**, Chicago, IL (US)

(*) Notice: This patent is subject to a terminal disclaimer.

(**) Term: **14 Years**

(21) Appl. No.: **29/228,469**

(22) Filed: **Apr. 22, 2005**

(51) **LOC (8) Cl.** **28-01**

(52) **U.S. Cl.** **D24/101**

(58) **Field of Classification Search** D24/100-104; D28/4, 8.1, 8.2; D1/100, 121, 125-128; 424/464-482

See application file for complete search history.

(56) **References Cited**

U.S. PATENT DOCUMENTS

- 462,990 A * 11/1891 Oppenheimer D28/8.1
- 1,580,576 A * 4/1926 Weidner 510/146
- 2,106,097 A * 1/1938 Homan D28/8.1
- D201,497 S * 6/1965 Ninger D24/103
- D229,049 S * 11/1973 Roberts D24/103
- 4,847,090 A * 7/1989 Della Posta et al. 424/440
- D376,251 S 12/1996 Manderfeld

- D397,507 S * 8/1998 Bern D28/8.1
- 6,004,334 A 12/1999 Mythen
- D443,105 S 5/2001 Friesenhahn
- D443,107 S 5/2001 Friesenhahn
- D447,316 S * 9/2001 Wolff D1/127
- D447,614 S * 9/2001 Wolff D1/127
- D447,835 S 9/2001 Whitaker et al.
- 6,663,892 B1 * 12/2003 Thassu 424/472

* cited by examiner

Primary Examiner—Charles A. Rademaker

(74) *Attorney, Agent, or Firm*—Steven P. Shurtz; Brinks Hofer Gilson & Lione

(57) **CLAIM**

The ornamental design for a circular tablet, as shown and described.

DESCRIPTION

FIG. 1 is a top perspective view of a circular tablet showing our new design with portions shown in stippling to indicate color contrast;

FIG. 2 is a side elevation, the other side elevations being identical;

FIG. 3 is a top plan view thereof;

FIG. 4 is a bottom plan view thereof;

FIG. 5 is a cross-sectional view thereof, taken through a diameter; and,

FIG. 6 is a top perspective view of a modified embodiment of the design shown in FIGS. 1 through 5, the other views being identical thereto apart from the lack of stippling to indicate color contrast.

1 Claim, 2 Drawing Sheets

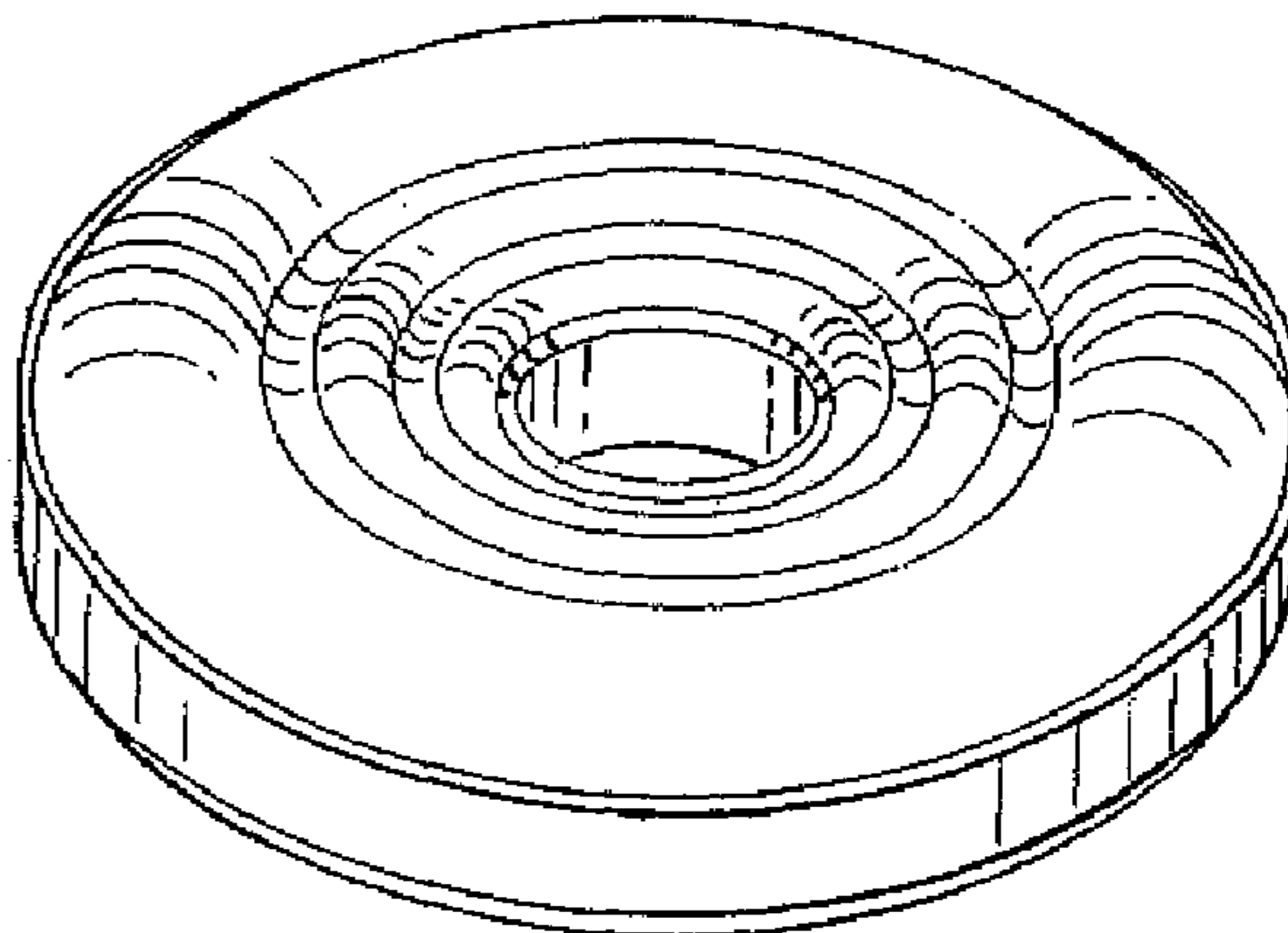
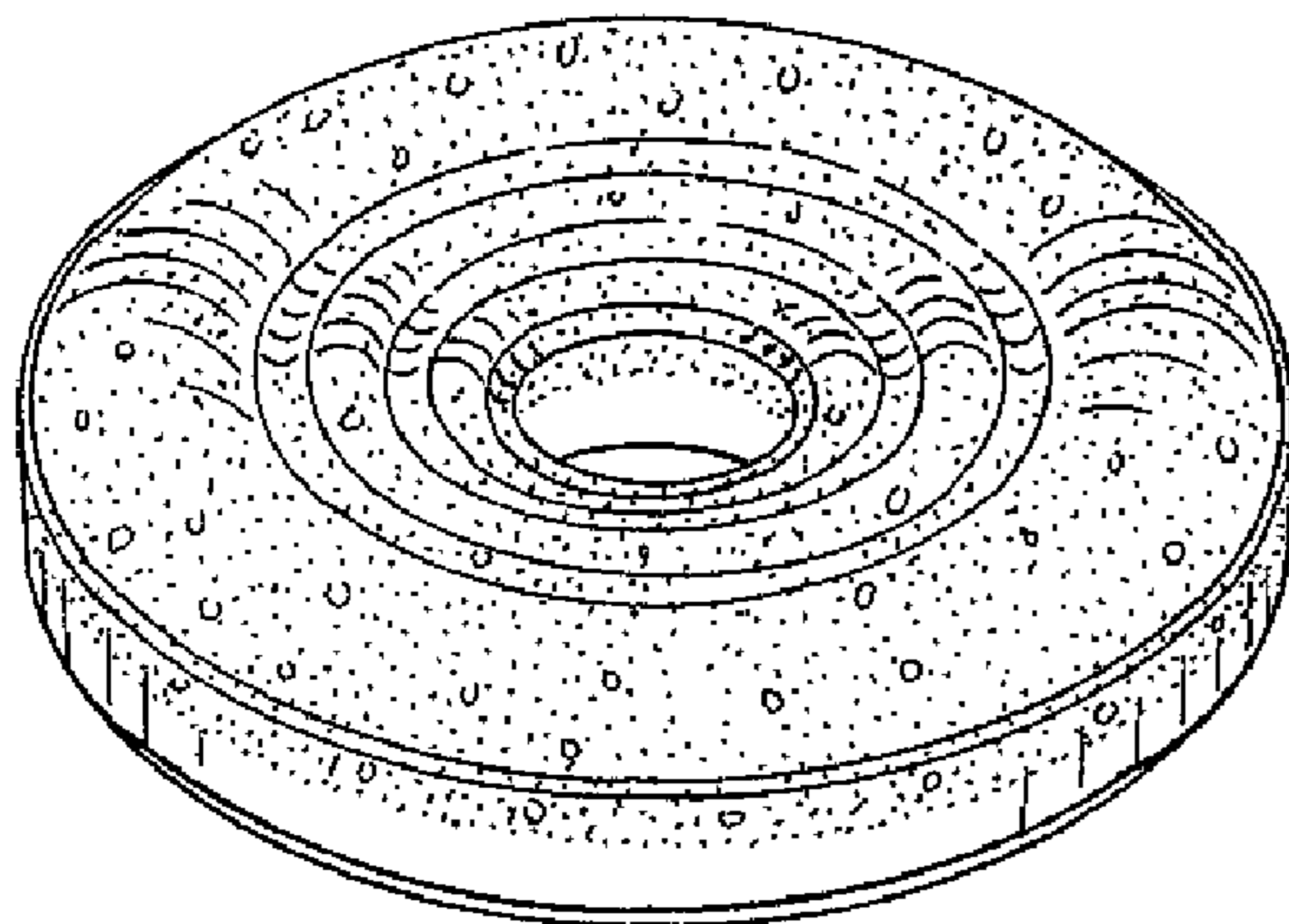

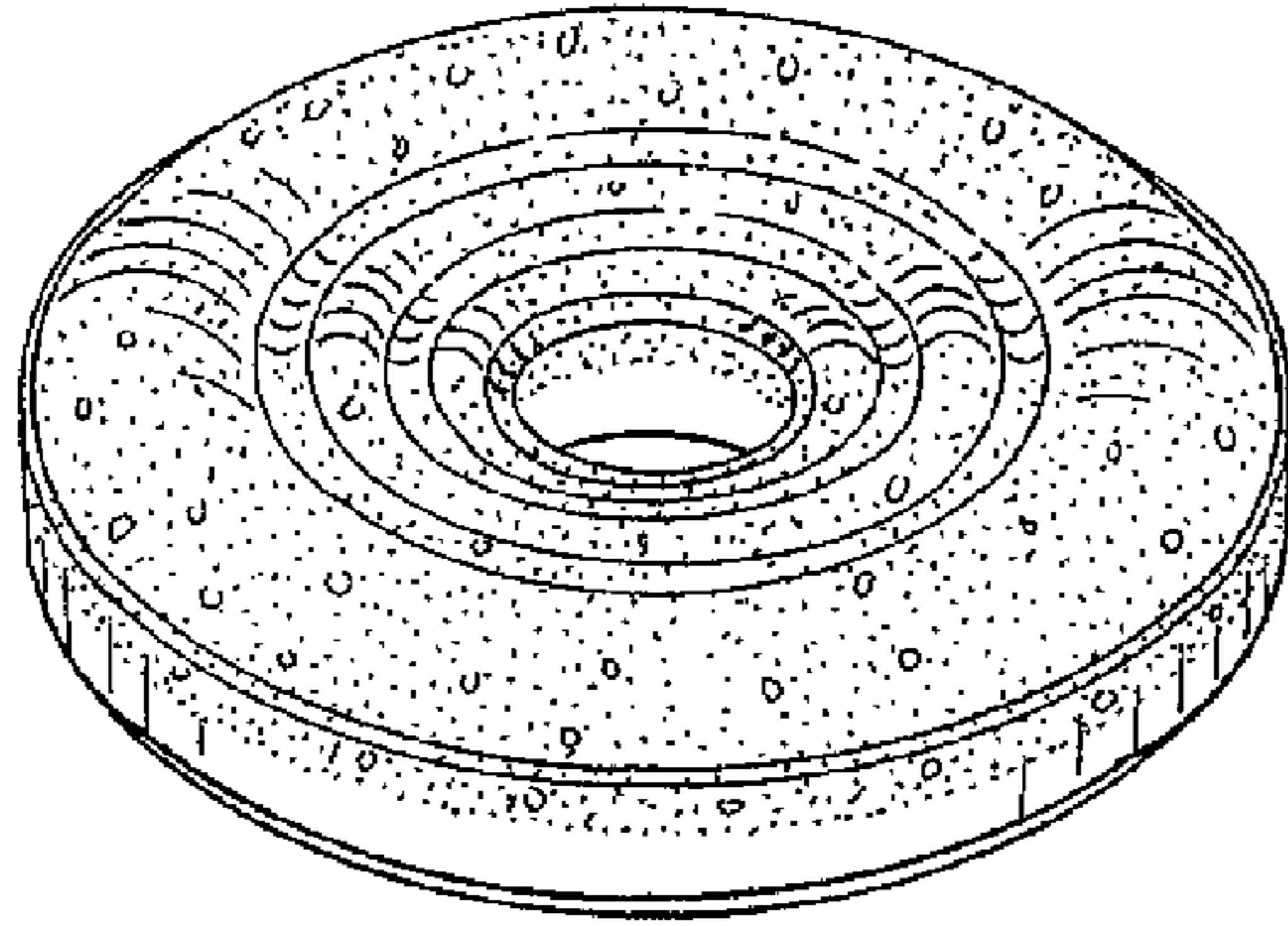

FIG. 1

FIG. 2

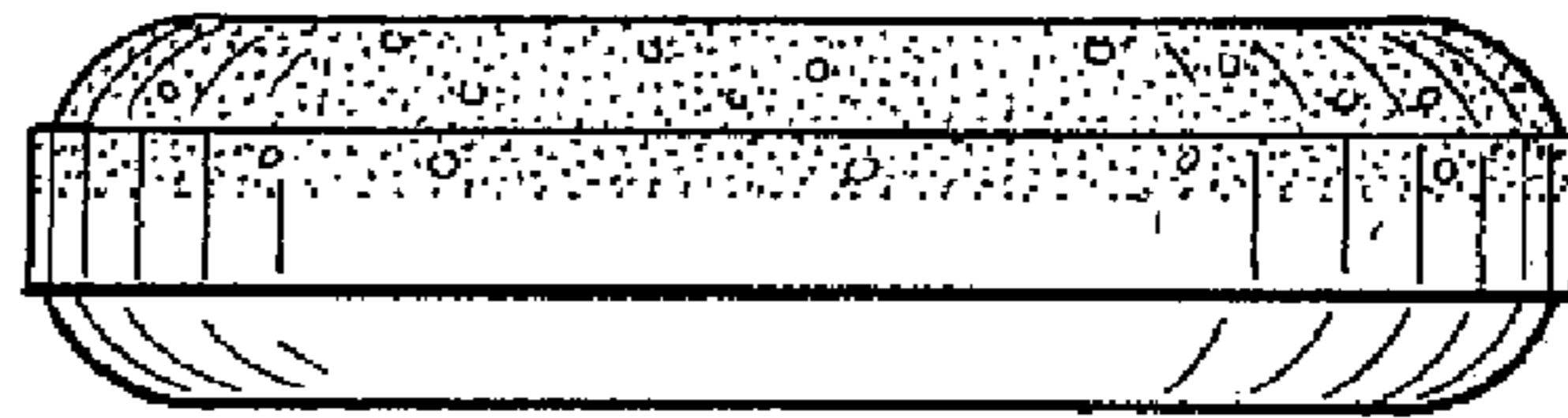

FIG. 3

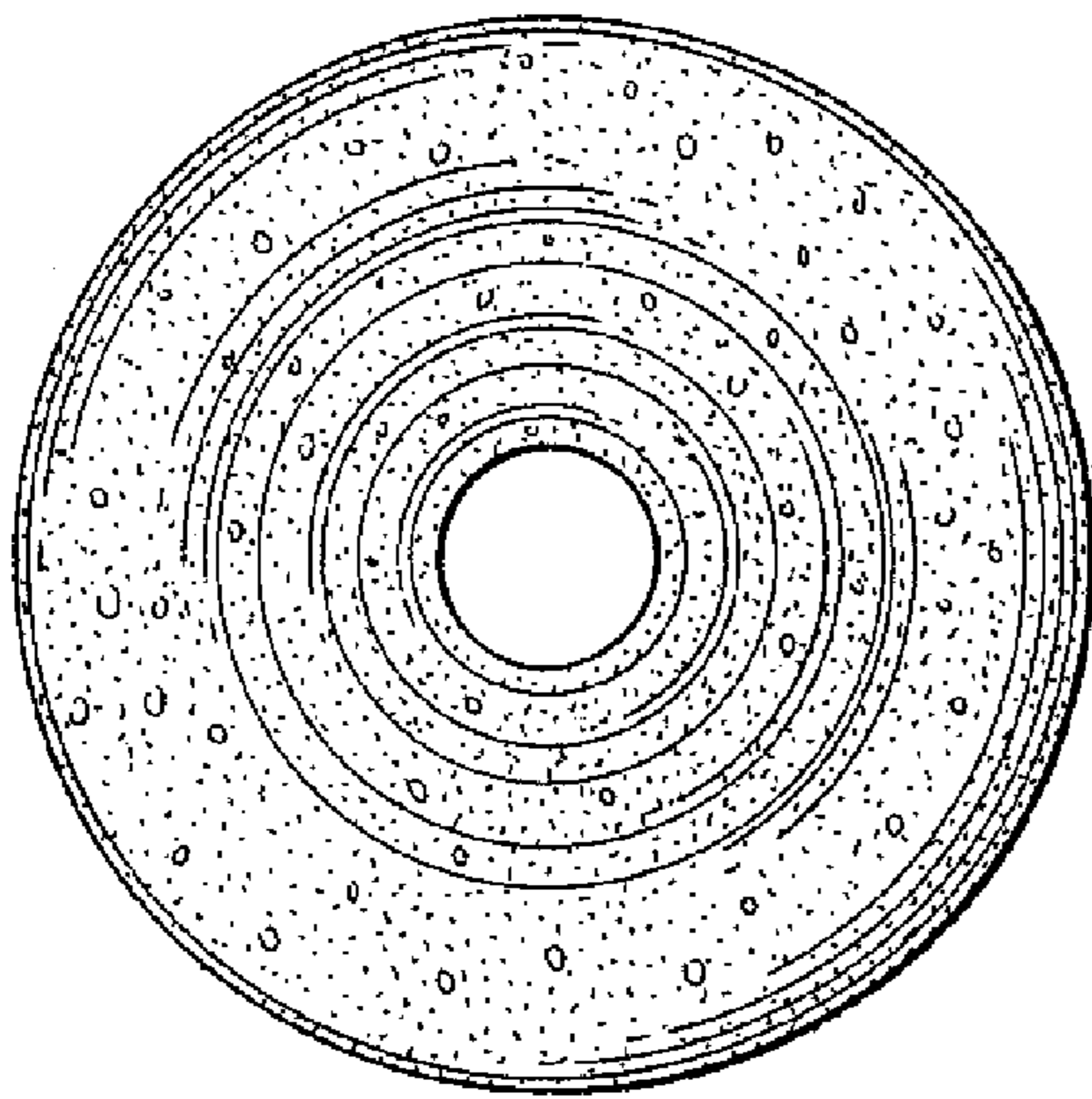

FIG. 4

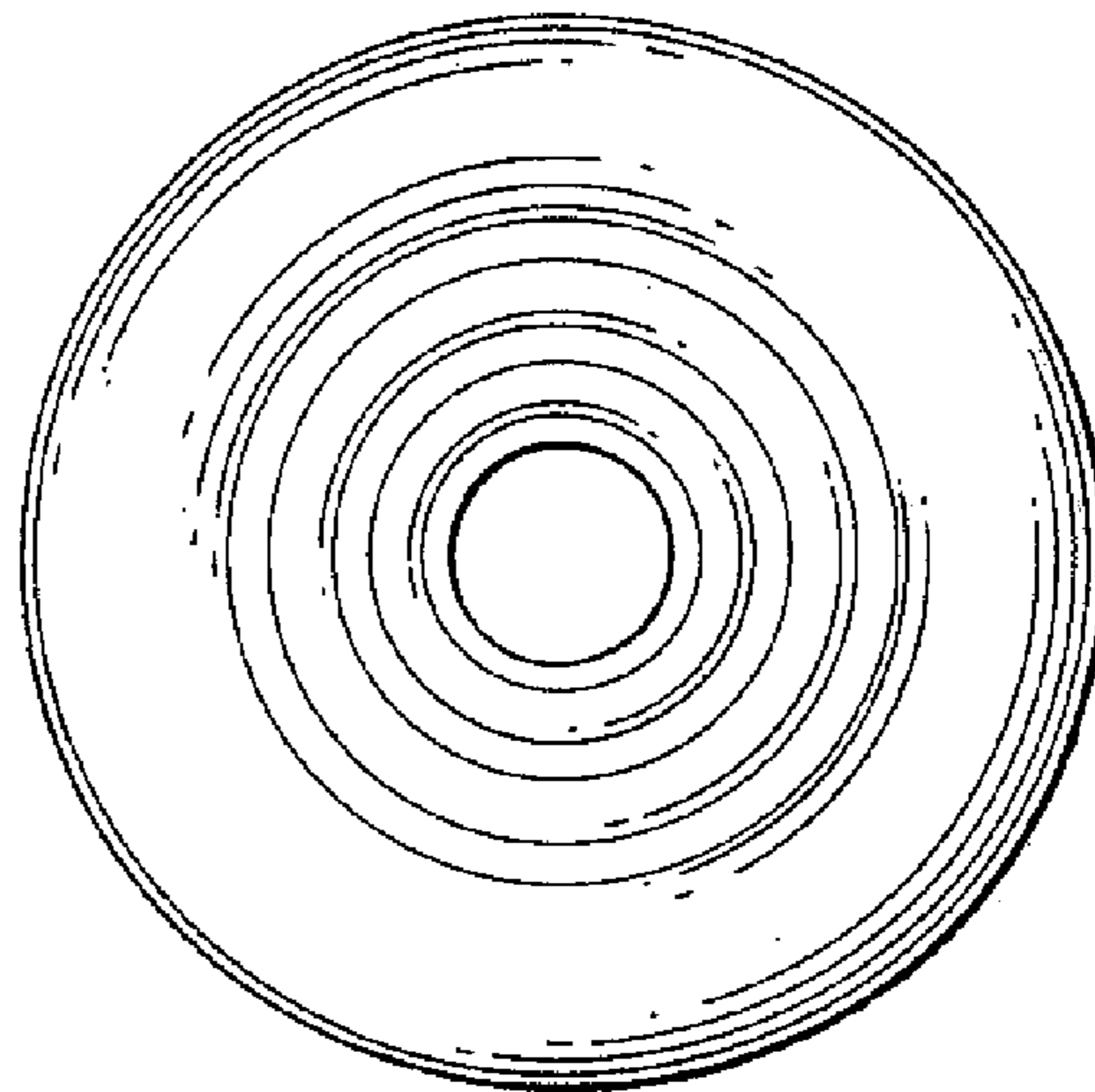

FIG. 5

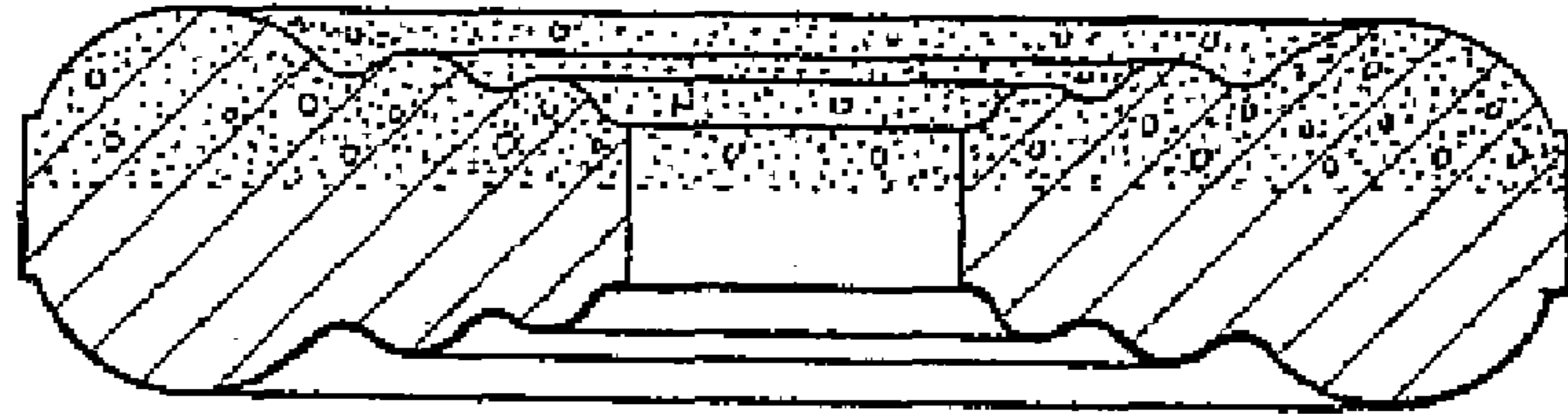

FIG. 6

