



US00D557781S

(12) **United States Design Patent**
Kim et al.

(10) **Patent No.: US D557,781 S**

(45) **Date of Patent: ** Dec. 18, 2007**

(54) **AIR CONDITIONER**

(75) Inventors: **Yun A. Kim**, Gyeonggi-Do (KR);
Hyun Joo Sim, Seoul (KR)

(73) Assignee: **Samsung Electronics Co., Ltd.** (KR)

(**) Term: **14 Years**

(21) Appl. No.: **29/256,871**

(22) Filed: **Aug. 18, 2006**

(30) **Foreign Application Priority Data**

Dec. 20, 2005 (KR) 30-2005-0043028

(51) **LOC (8) Cl.** **23-04**

(52) **U.S. Cl.** **D23/351**

(58) **Field of Classification Search** D23/351-354;
62/259.1, 259.4, 262-263, 285, 298; 312/236;
165/58; 454/292, 305, 339, 349

See application file for complete search history.

(56) **References Cited**

U.S. PATENT DOCUMENTS

D323,209 S *	1/1992	Fukumoto et al.	D23/351
D331,458 S *	12/1992	Saito et al.	D23/351
D398,974 S *	9/1998	Aihara	D23/351
D401,682 S *	11/1998	Galeazzi et al.	D23/351
D424,672 S *	5/2000	Nanjo	D23/353
D426,292 S *	6/2000	Nanjo	D23/351
D448,462 S *	9/2001	Nanjo	D23/351
D469,173 S *	1/2003	Kawanori et al.	D23/351
D539,887 S *	4/2007	Kato	D23/351
D539,888 S *	4/2007	Tsuji	D23/351

* cited by examiner

Primary Examiner—Brian N Vinson

(74) *Attorney, Agent, or Firm*—Irving Keschner

(57) **CLAIM**

The ornamental design for air conditioner, as shown.

DESCRIPTION

FIG. 1 is a perspective view of the ornamental design of the present invention;

FIG. 2 is a front elevational view of the ornamental design of the present invention;

FIG. 3 is a rear elevational view of the ornamental design of the present invention;

FIG. 4 is a left side elevational view of the ornamental design of the present invention;

FIG. 5 is a right side elevational view of the ornamental design of the present invention;

FIG. 6 is a top plan view of the ornamental design of the present invention;

FIG. 7 is a bottom view of the ornamental design of the present invention;

FIG. 8 illustrates the panel of the air conditioner of the present invention is downward; and,

FIG. 9 illustrates the air conditioner of the present invention installed in a ceiling, the dotted lines forming no part of the invention.

1 Claim, 4 Drawing Sheets

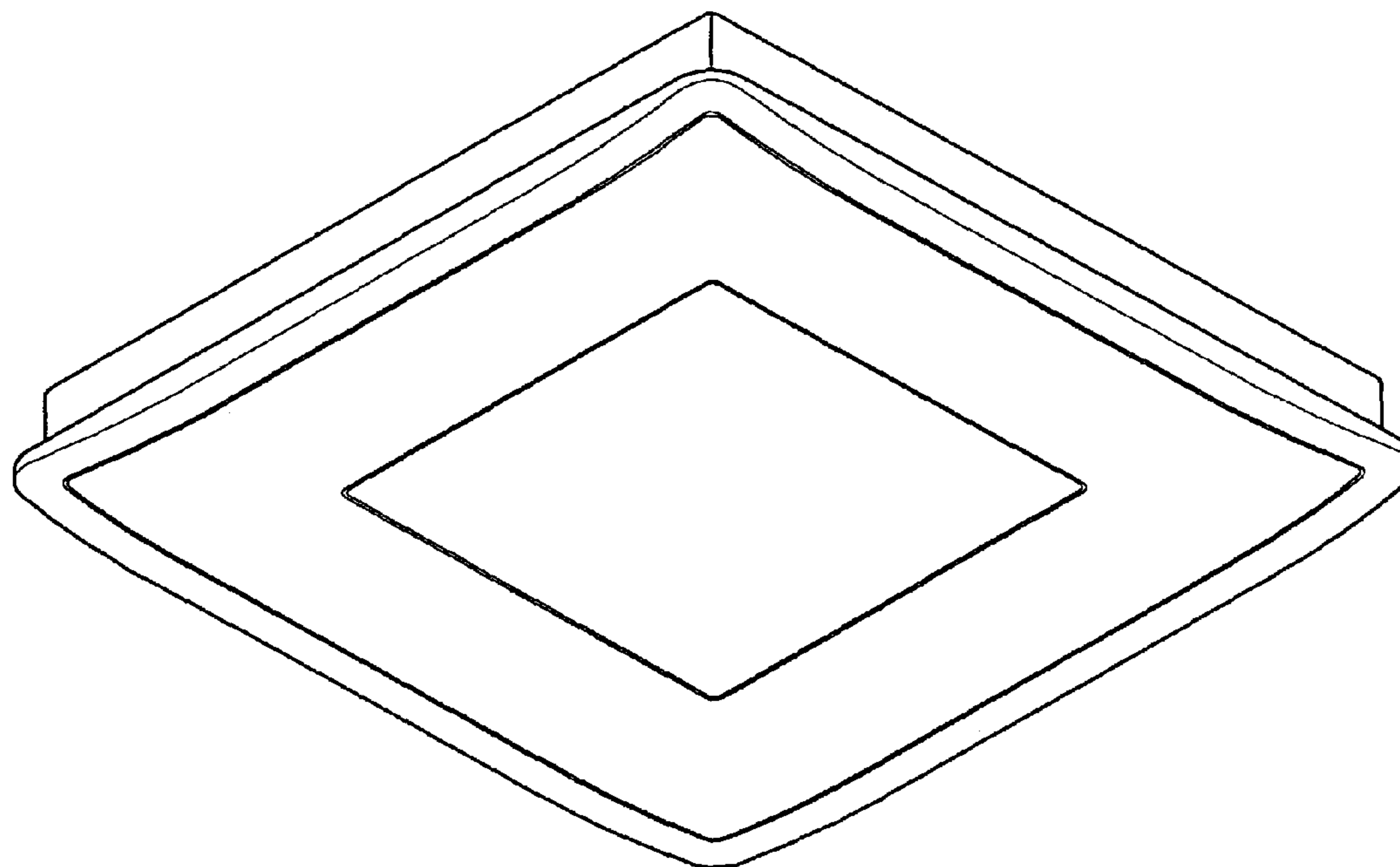

Fig. 1

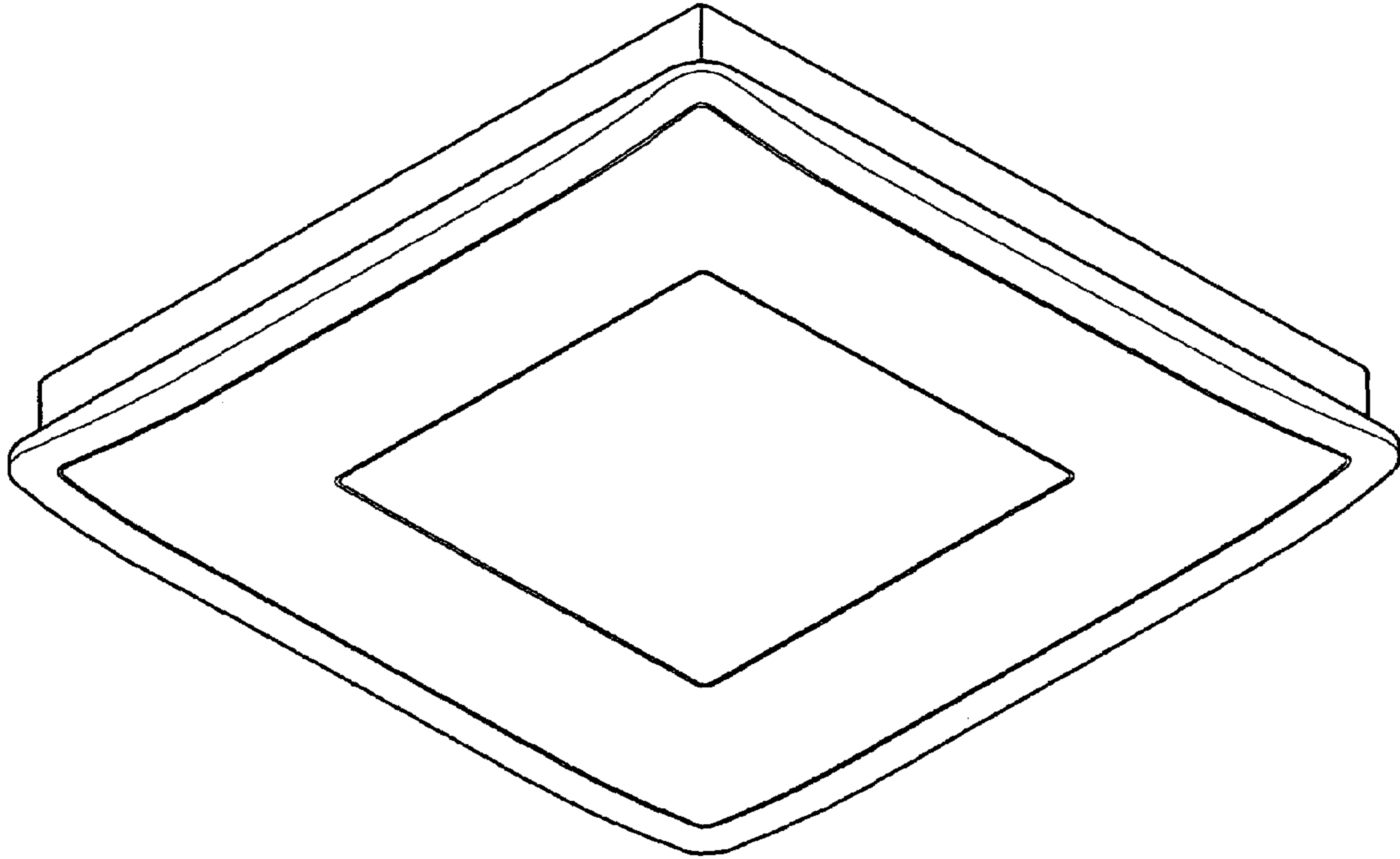

Fig. 2

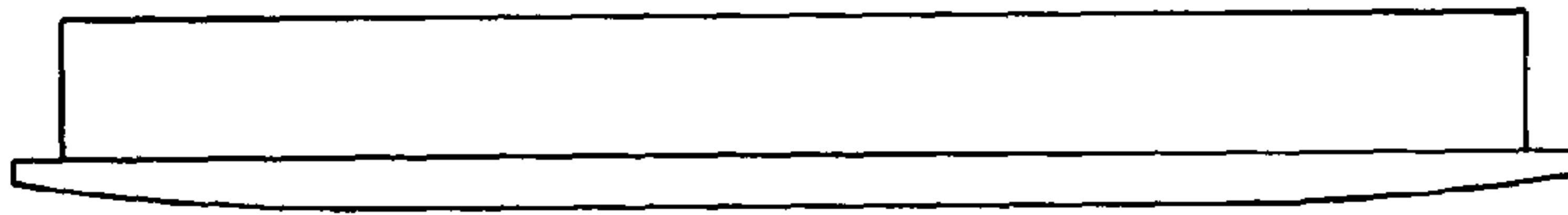

Fig. 3

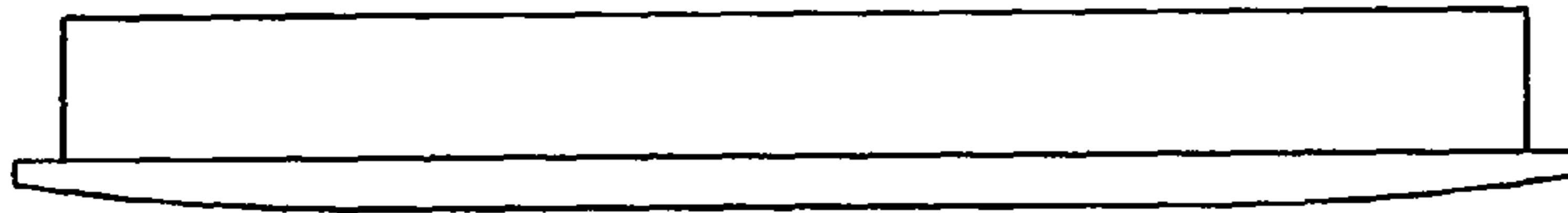

Fig. 4



Fig. 5

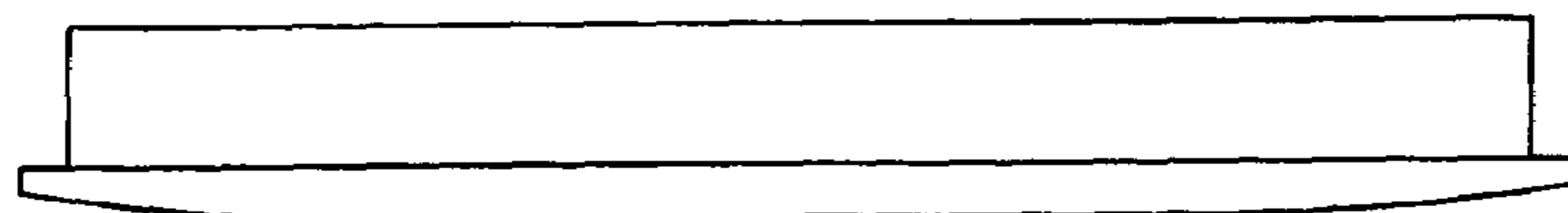

Fig. 6

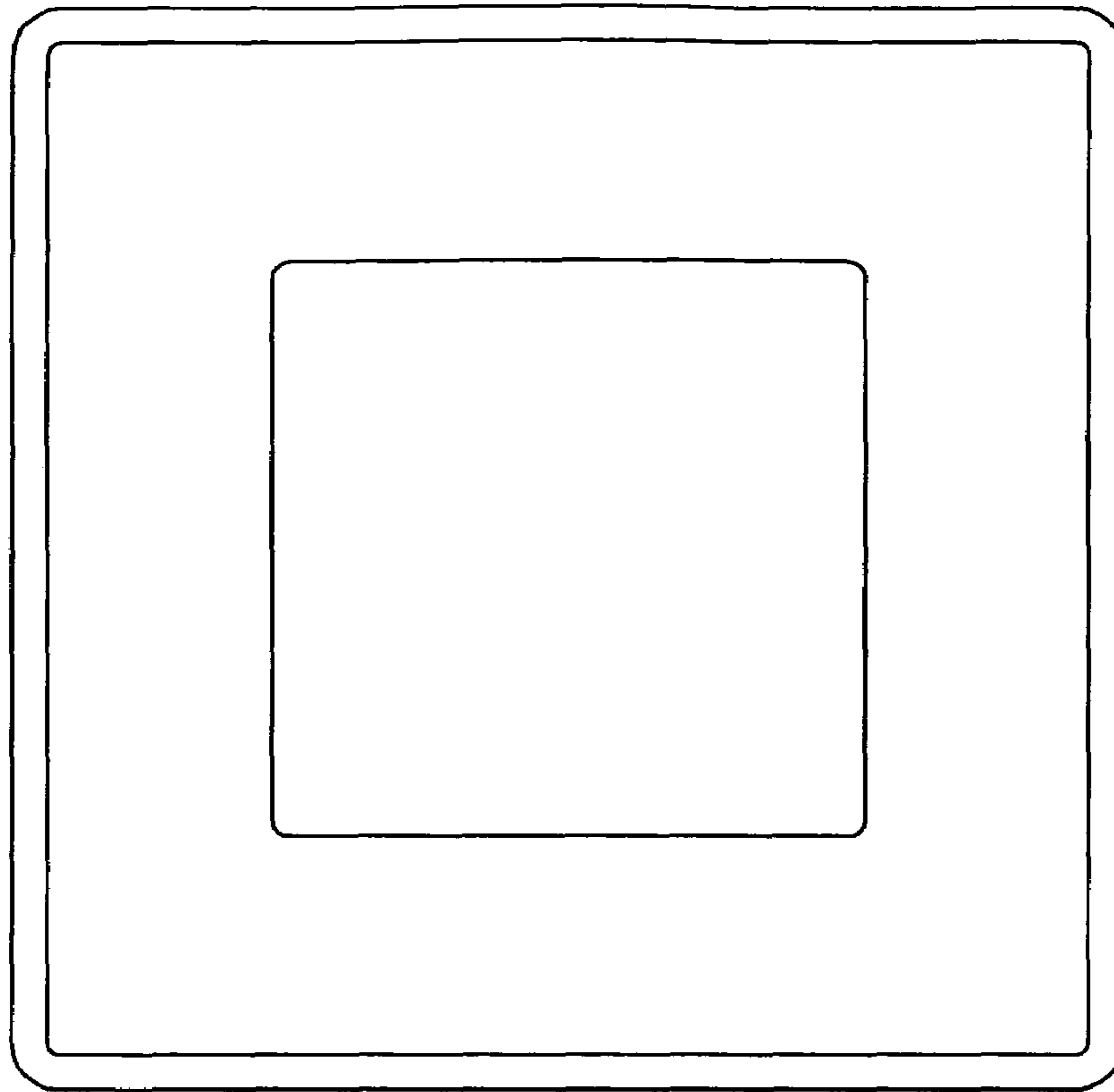

Fig. 7

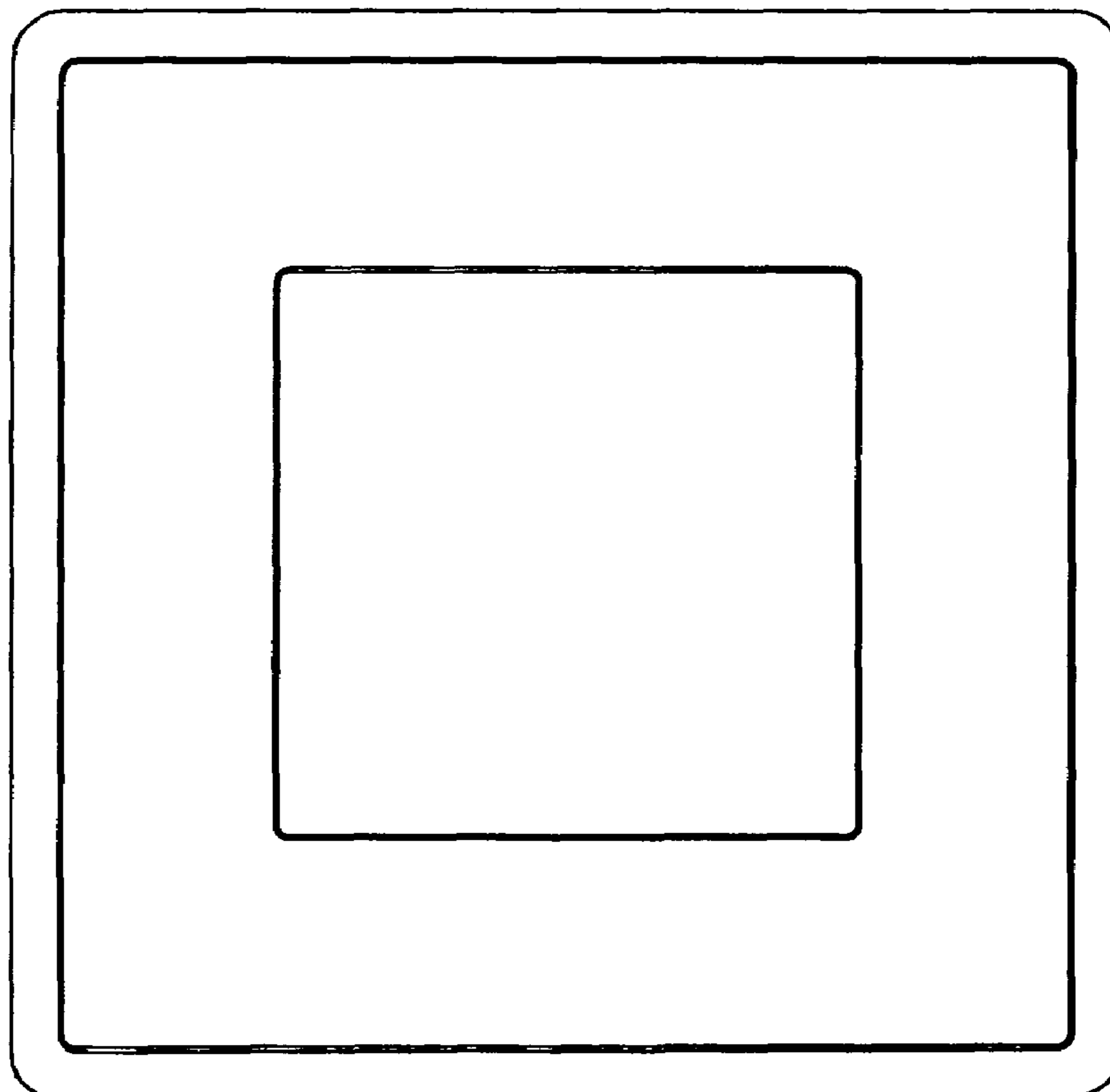

Fig. 8

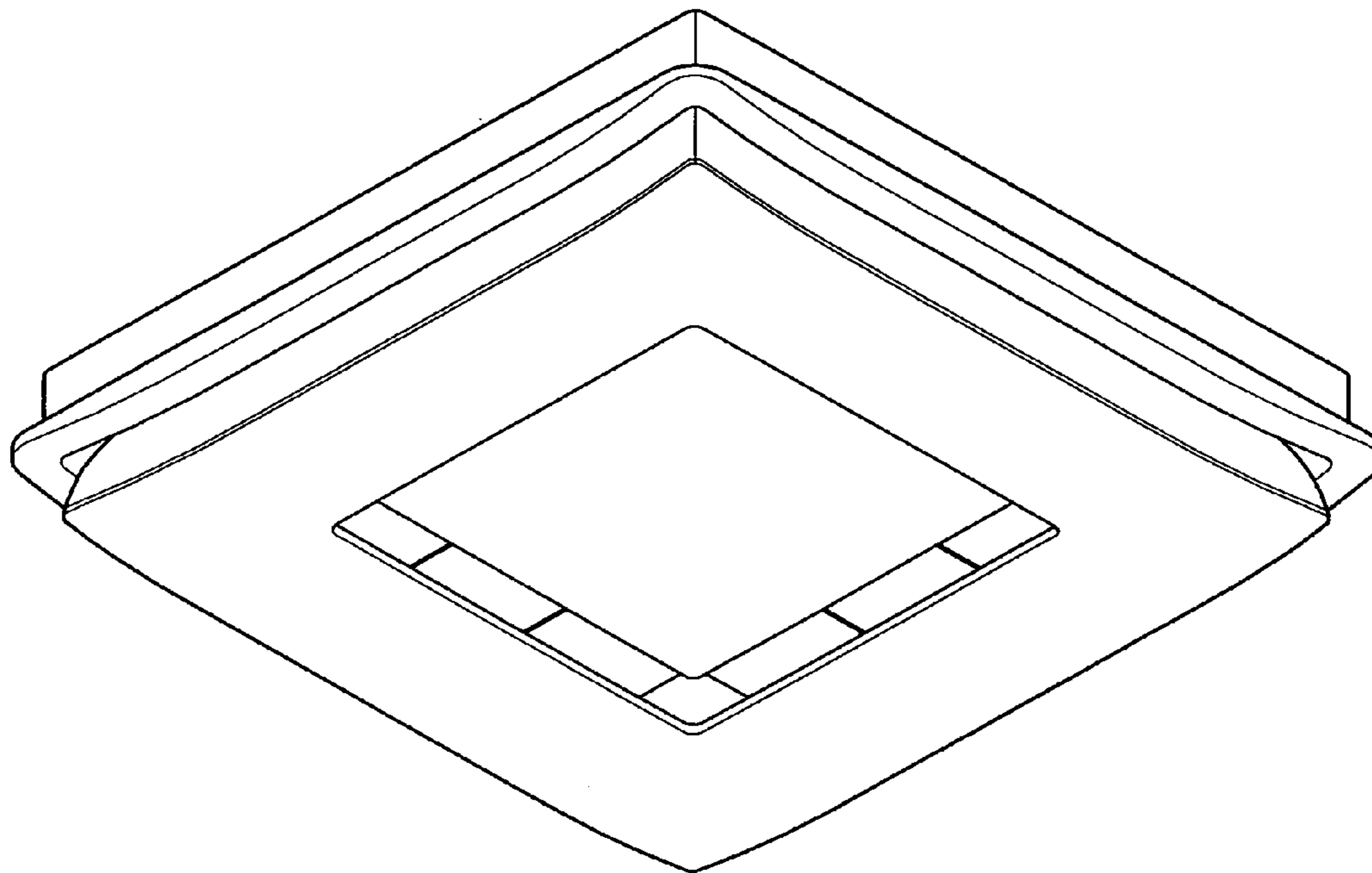

Fig. 9

