



US00D557671S

(12) **United States Design Patent**
Kim et al.

(10) **Patent No.:** **US D557,671 S**

(45) **Date of Patent:** **** Dec. 18, 2007**

(54) **MOBILE PHONE**

(75) Inventors: **Young Se Kim**, Palo Alto, CA (US);
Young Ju Yeo, Seoul (KR); **Chang Hwan Hwang**, Kyunggi-do (KR)

(73) Assignee: **Samsung Electronics Co., Ltd.** (KR)

(**) Term: **14 Years**

(21) Appl. No.: **29/259,767**

(22) Filed: **May 15, 2006**

(51) **LOC (8) Cl.** **14-03**

(52) **U.S. Cl.** **D14/138**

(58) **Field of Classification Search** D14/137,
D14/138, 147, 218, 341-347, 496; 455/90.3,
455/556.1, 556.2, 575.1, 575.3, 575.4; 379/433.01-433.13;
361/814; 348/14.02

See application file for complete search history.

(56) **References Cited**

U.S. PATENT DOCUMENTS

D479,214 S *	9/2003	Bertrand et al.	D14/138
D509,206 S *	9/2005	Jang	D14/138
D525,225 S *	7/2006	Lee	D14/138
D525,611 S *	7/2006	Jang	D14/138
D525,959 S *	8/2006	Kim et al.	D14/138
D526,300 S *	8/2006	Lee	D14/138
D527,000 S *	8/2006	Hong et al.	D14/346
D527,365 S *	8/2006	Jang	D14/138
D528,095 S *	9/2006	Kwon et al.	D14/138
D529,465 S *	10/2006	Kim et al.	D14/138
D529,471 S *	10/2006	Park	D14/138
D530,299 S *	10/2006	Lee	D14/138
D533,160 S *	12/2006	Yoo et al.	D14/138
D533,532 S *	12/2006	Kim et al.	D14/138
D534,143 S *	12/2006	Lheem	D14/138
D534,145 S *	12/2006	Lheem	D14/138
D534,515 S *	1/2007	Kim et al.	D14/138
D534,888 S *	1/2007	Kim et al.	D14/138
D534,890 S *	1/2007	Kim	D14/138
D534,893 S *	1/2007	Jo et al.	D14/138
7,158,371 B2 *	1/2007	Park et al.	361/679
2003/0211874 A1 *	11/2003	Mizuta et al.	455/575.4
2005/0014538 A1 *	1/2005	Hyun et al.	455/575.4

2005/0124394 A1 *	6/2005	Kim et al.	455/575.3
2006/0025184 A1 *	2/2006	Cho et al.	455/575.4
2006/0287015 A1 *	12/2006	Dunko	455/575.4

OTHER PUBLICATIONS

Motorola E680, announced 1st quarter 2004, [online], [retrieved on Feb. 16, 2007]. Retrieved from Internet ,<URL: http://www.gsmarena.com>.*

Pantech PU-5000, announced Jun. 2006, [online], [retrieved on Feb. 20, 2007]. Retrieved from Internet ,<URL: http://www.gsmarena.com>.*

(Continued)

Primary Examiner—Jeffrey Asch

Assistant Examiner—Bridget L. Eland

(74) *Attorney, Agent, or Firm*—Irving Keschner

(57) **CLAIM**

The ornamental design for mobile phone, as shown.

DESCRIPTION

FIG. 1 is a perspective view of the ornamental design of the present invention;

FIG. 2 is a front elevational view of the ornamental design of the present invention;

FIG. 3 is a rear elevational view of the ornamental design of the present invention;

FIG. 4 is a left side elevational view of the ornamental design of the present invention;

FIG. 5 is a right side elevational view of the ornamental design of the present invention;

FIG. 6 is a top plan view of the ornamental design of the present invention;

FIG. 7 is a bottom view of the ornamental design of the present invention;

FIG. 8 is a perspective view of the mobile phone showing the slide in the up position; and,

FIG. 9 is a perspective view of the mobile phone showing the slide turned around.

1 Claim, 7 Drawing Sheets

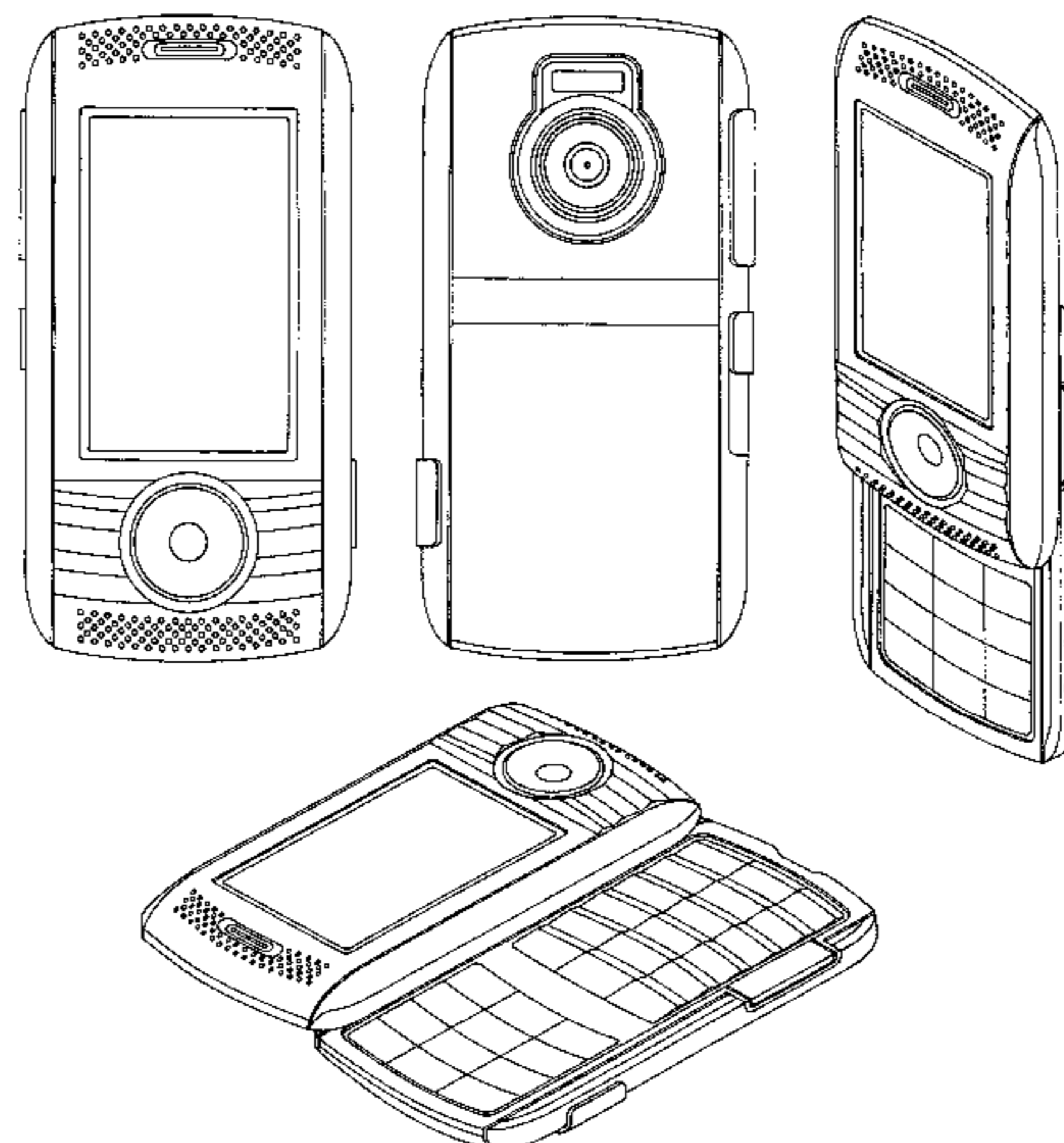

OTHER PUBLICATIONS

Gigabyte g-Smart i300, announced 2nd quarter 2006, [online], [retrieved on Feb. 20, 2007]. Retrieved from Internet ,<URL: <http://www.gsmarena.com>>.*

i-mate PDAL, announced Nov. 2006, [online], [retrieved on Feb. 20, 2007]. Retrieved from Internet ,<URL: <http://www.gsmarena.com>>.*

Motorola ROKR E6, announced Dec. 2006, [online], [retrieved on Feb. 16, 2007]. Retrieved from Internet ,<URL: <http://www.gsmarena.com>>.*

Toshiba G500, announced Feb. 2007, [online], [retrieved on Feb. 20, 2007]. Retrieved from Internet ,<URL: <http://www.gsmarena.com>>.*

HTC P3350, announced Feb. 2007, [online], [retrieved on Feb. 20, 2007]. Retrieved from Internet ,<URL: <http://www.gsmarena.com>>.*

Gigabyte g-Smart t600, announced Feb. 2007, [online], [retrieved on Mar. 12, 2007]. Retrieved from Internet ,<URL: <http://www.gsmarena.com>>.*

* cited by examiner

FIG. 1

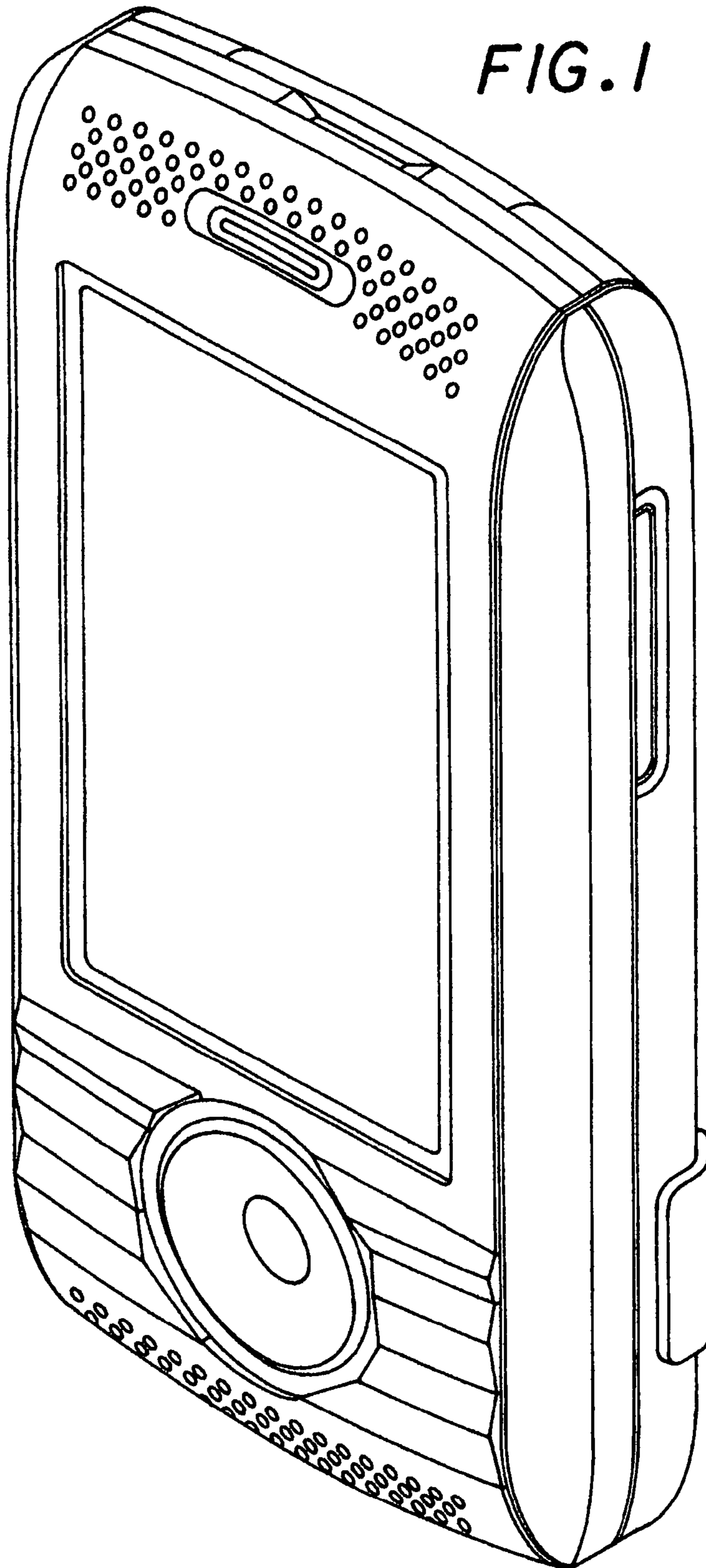

FIG. 2

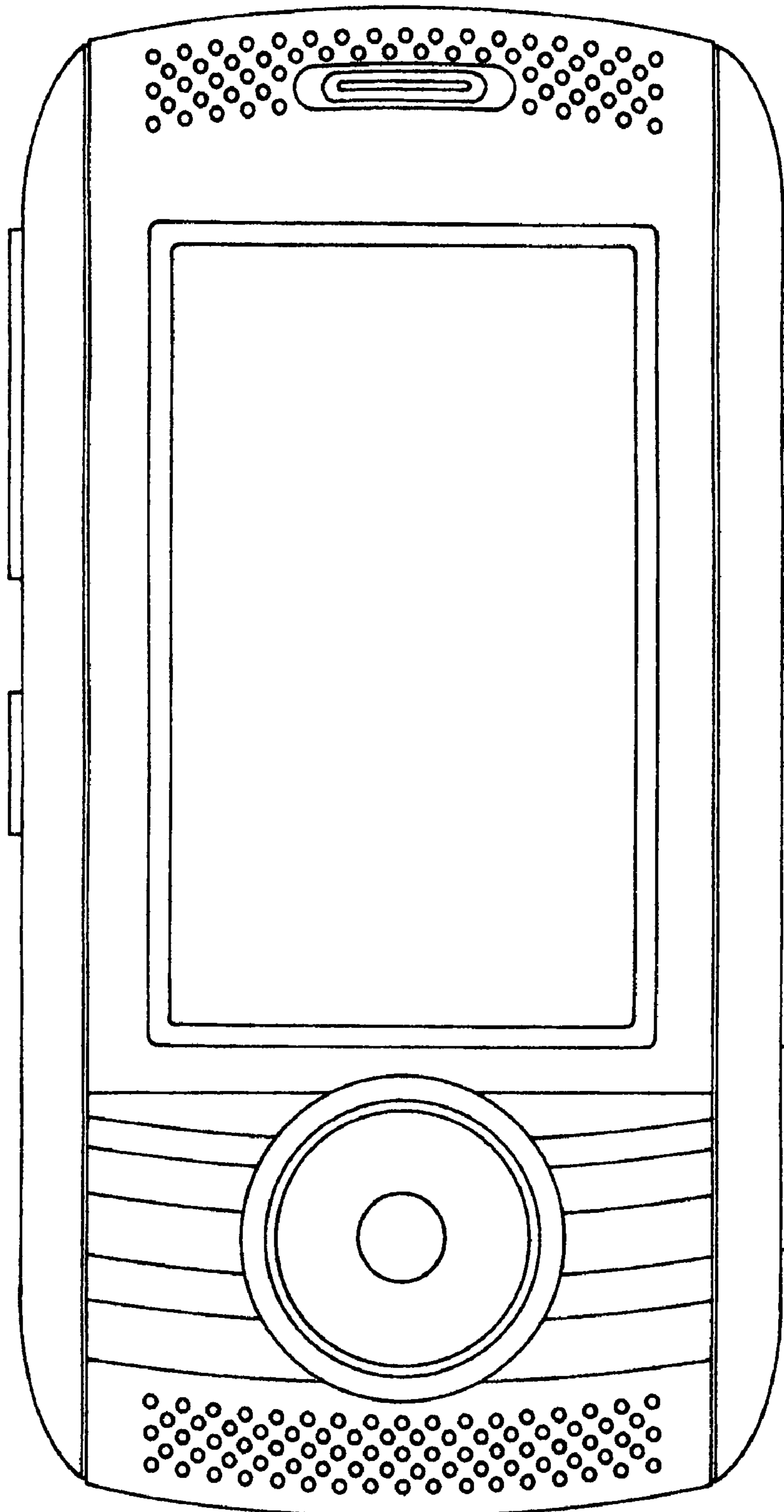

FIG. 3

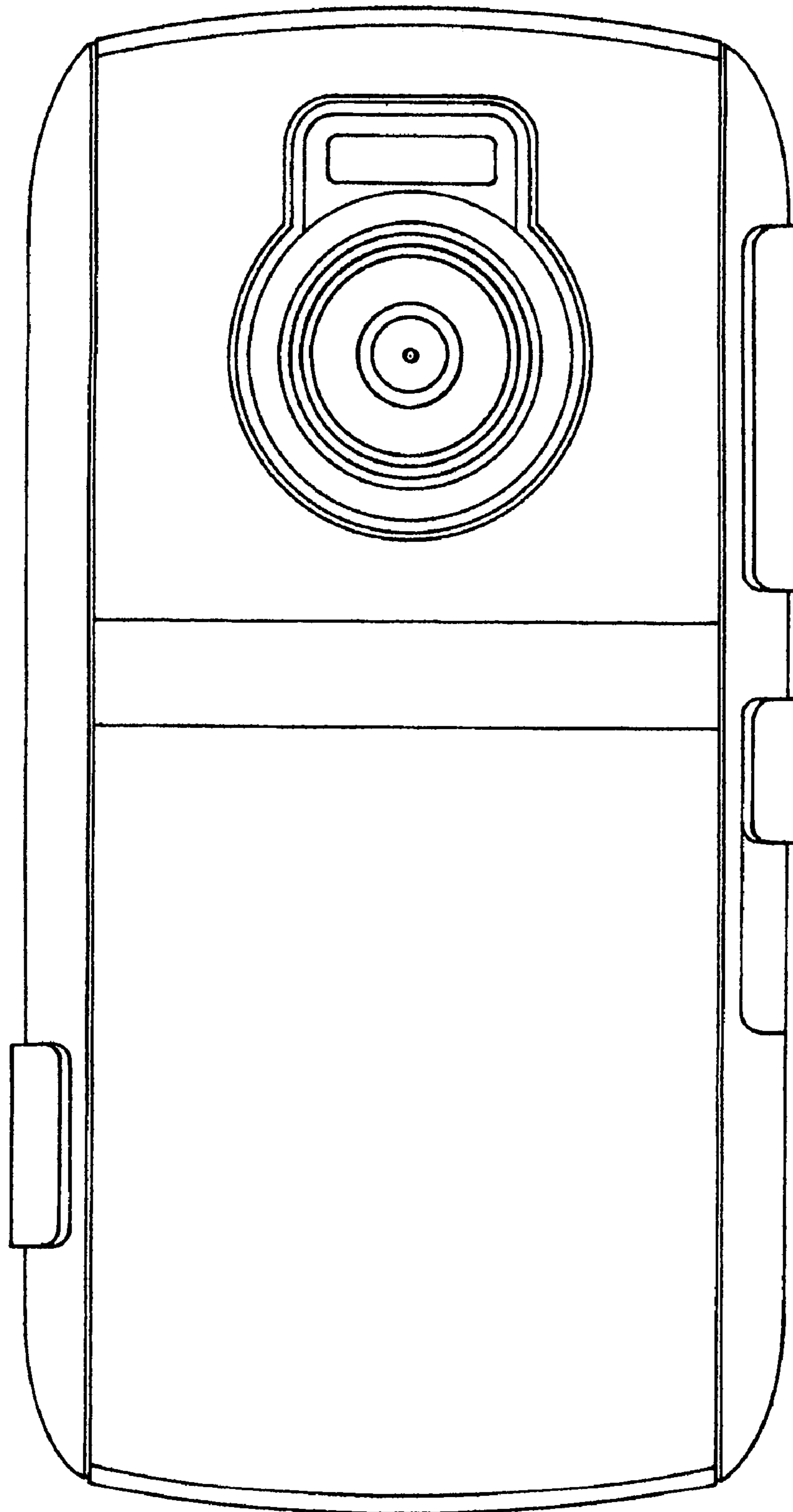

FIG. 4

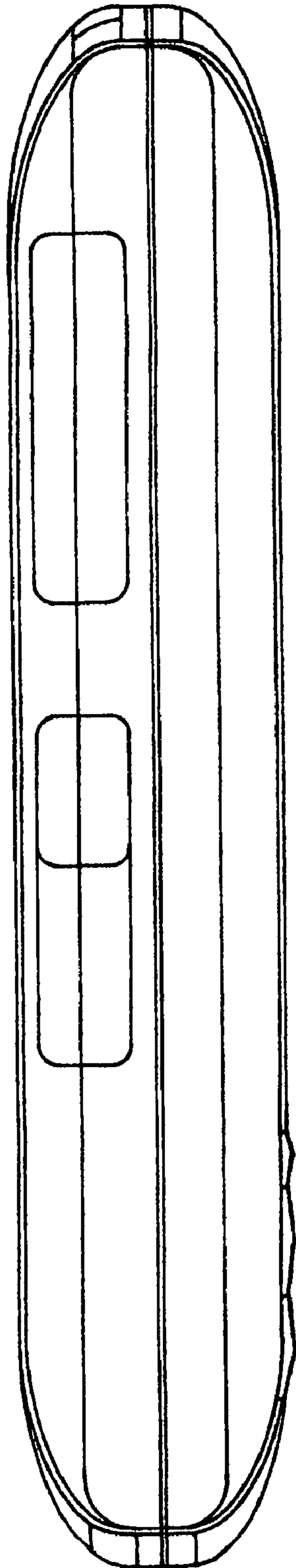

FIG. 5

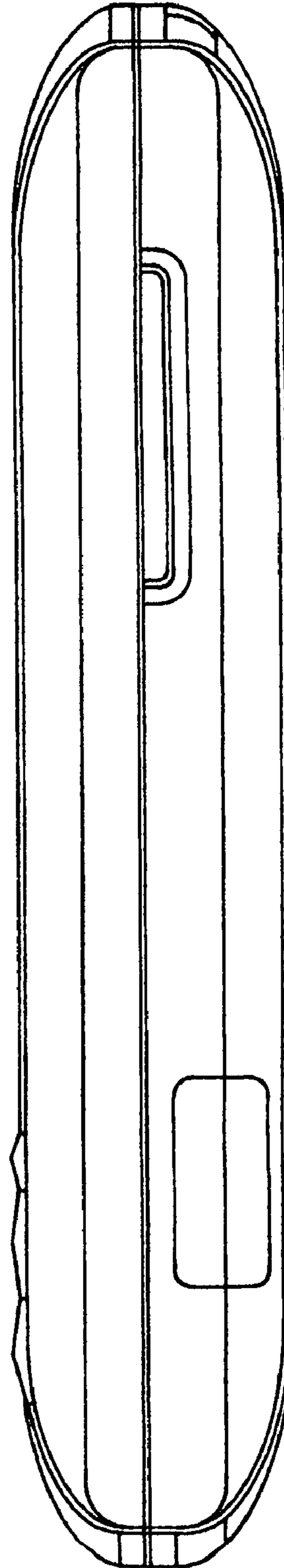

FIG. 6

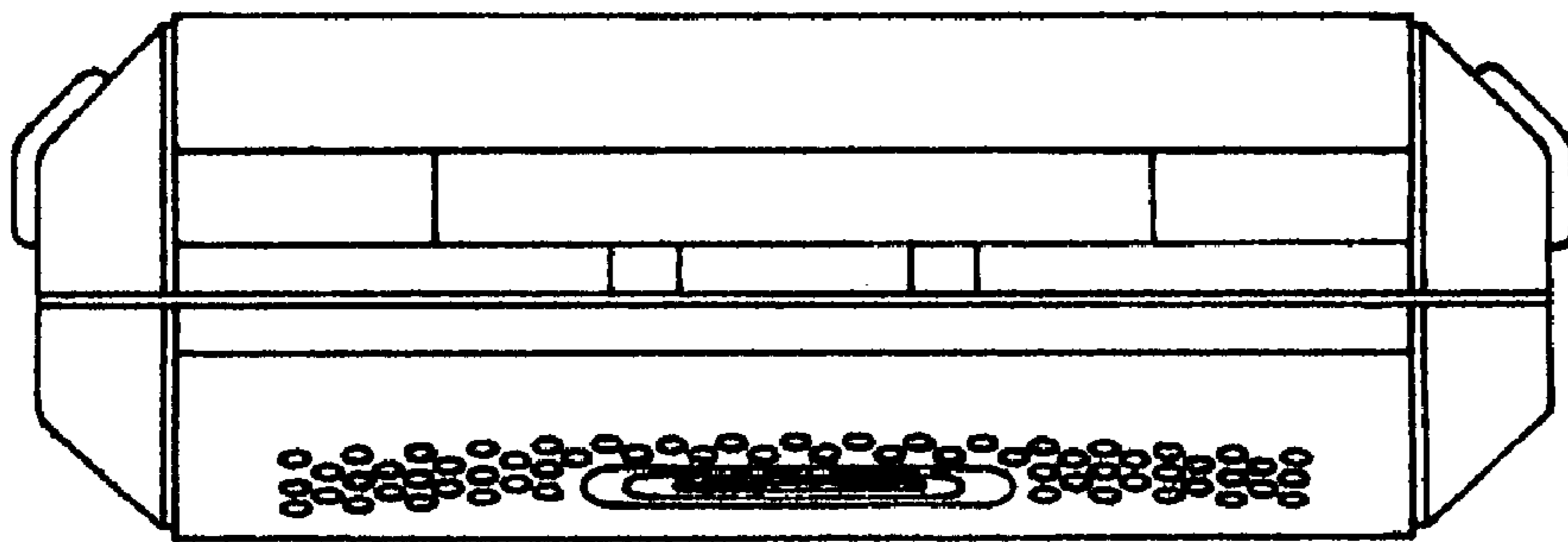

FIG. 7

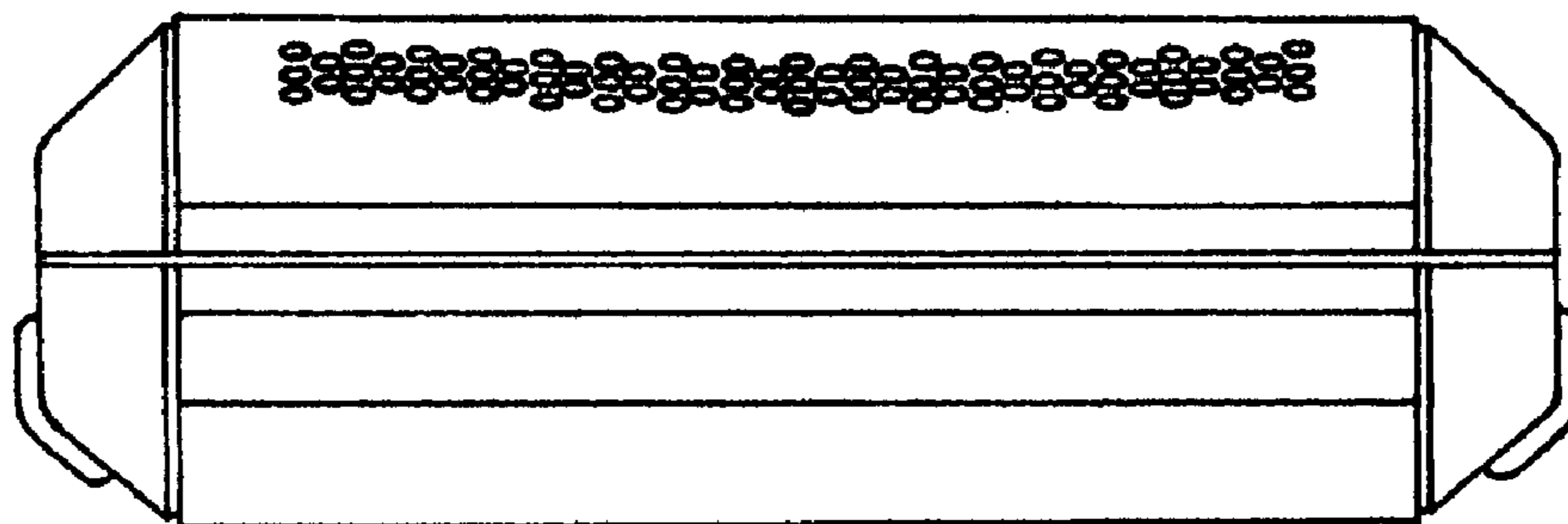
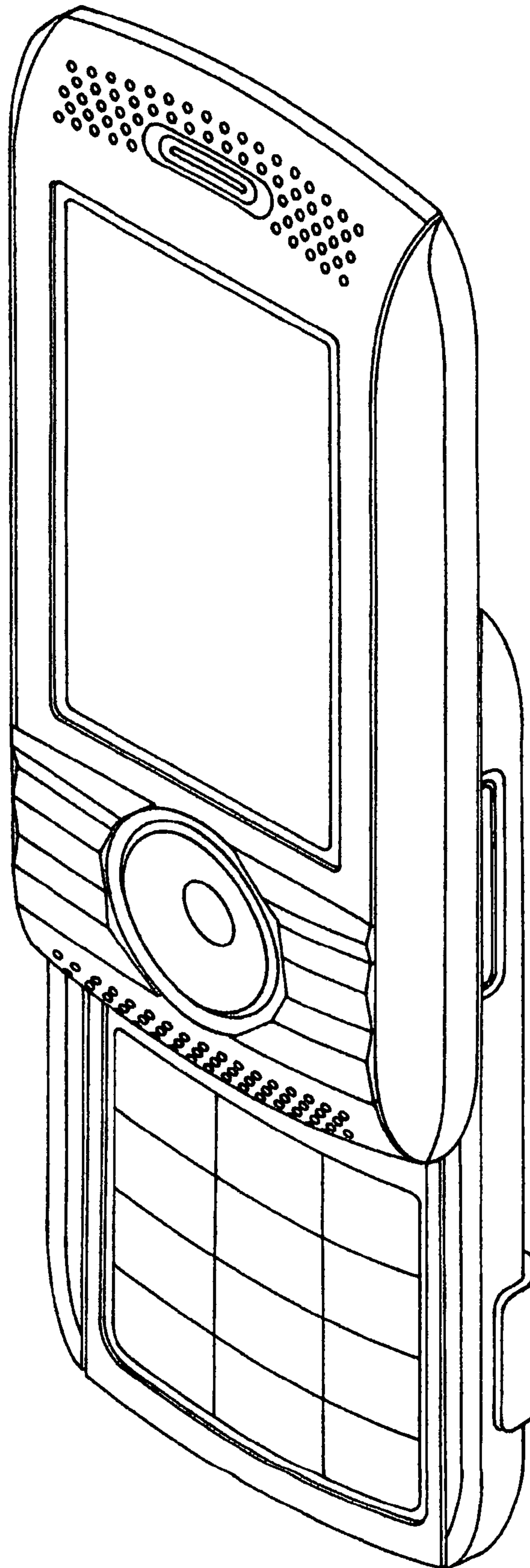

FIG. 8



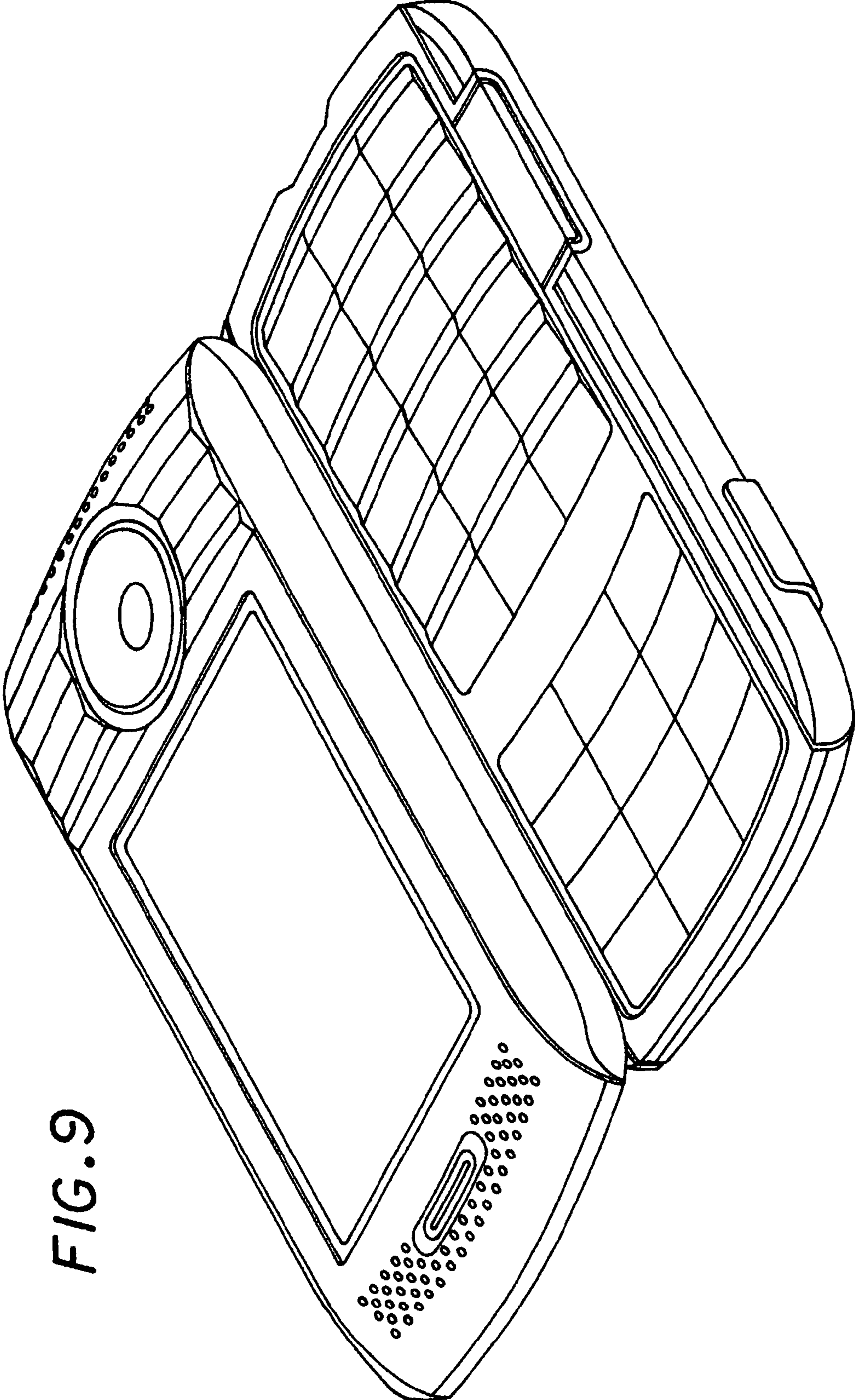

FIG. 9