



US00D557657S

(12) **United States Design Patent**
Yabe et al.

(10) **Patent No.:** **US D557,657 S**

(45) **Date of Patent:** **** Dec. 18, 2007**

(54) **BATTERY PACK**

(75) Inventors: **Tomohiro Yabe**, Tokyo (JP); **Michio Deguchi**, Tokyo (JP)

(73) Assignee: **Sony Computer Entertainment, Inc.**, Tokyo (JP)

(**) Term: **14 Years**

(21) Appl. No.: **29/216,859**

(22) Filed: **Nov. 10, 2004**

(30) **Foreign Application Priority Data**

May 10, 2004 (JP) D2004-013702

(51) **LOC (8) Cl.** **13-02**

(52) **U.S. Cl.** **D13/103**

(58) **Field of Classification Search** D13/102–106,
D13/110, 118–119, 184; 429/96–100, 163,
429/176

See application file for complete search history.

(56) **References Cited**

U.S. PATENT DOCUMENTS

D246,240 S	*	11/1977	Hansen	D13/103
D297,633 S	*	9/1988	Peroni	D13/184
D344,061 S	*	2/1994	Tse	D13/103
D362,003 S	*	9/1995	Claudio	D14/240
D363,722 S	*	10/1995	Aldridge et al.	D14/242
D367,756 S		3/1996	Ohba		
D380,199 S	*	6/1997	Beruscha et al.	D13/184
D397,670 S	*	9/1998	Davies et al.	D13/103
D398,899 S	*	9/1998	Chaco	D13/103
D409,137 S		5/1999	Sumita		
D415,133 S	*	10/1999	Mah	D14/432
D464,031 S	*	10/2002	Gillingham	D13/184
D506,065 S	*	6/2005	Sugino et al.	D3/294

* cited by examiner

Primary Examiner—M. H. Tung

Assistant Examiner—Rosemary K. Tarcza

(74) *Attorney, Agent, or Firm*—Rader, Fishman & Grauer PLLC

(57) **CLAIM**

The ornamental design for a battery pack, as shown.

DESCRIPTION

FIG. 1 is a front elevational view of a battery pack showing our new design;

FIG. 2 is a rear elevational view thereof;

FIG. 3 is a left side elevational view thereof;

FIG. 4 is a right side elevational view thereof;

FIG. 5 is a top plan view thereof;

FIG. 6 is a bottom plan view thereof;

FIG. 7 is a front top right perspective view thereof;

FIG. 8 is a rear bottom right perspective view thereof;

FIG. 9 is a reference reduced front elevational view thereof, showing lines X-X, XI-XI, XII-XII, XIII-XIII and XIV-XIV;

FIG. 10 is a reference cross sectional view thereof, taken along the line X-X shown in FIG. 9, on a slightly reduced scale;

FIG. 11 is a reference cross sectional view thereof, taken along the line XI-XI shown in FIG. 9, on a slightly reduced scale;

FIG. 12 is a reference cross section view thereof, taken along the line XII-XII shown in FIG. 9, on a slightly reduced scale;

FIG. 13 is a reference cross sectional view thereof, taken along the line XIII-XIII shown in FIG. 9, on a slightly reduced scale; and,

FIG. 14 is a reference cross sectional view thereof, taken along the line XIV-XIV shown in FIG. 9, on a slightly reduced scale.

1 Claim, 5 Drawing Sheets

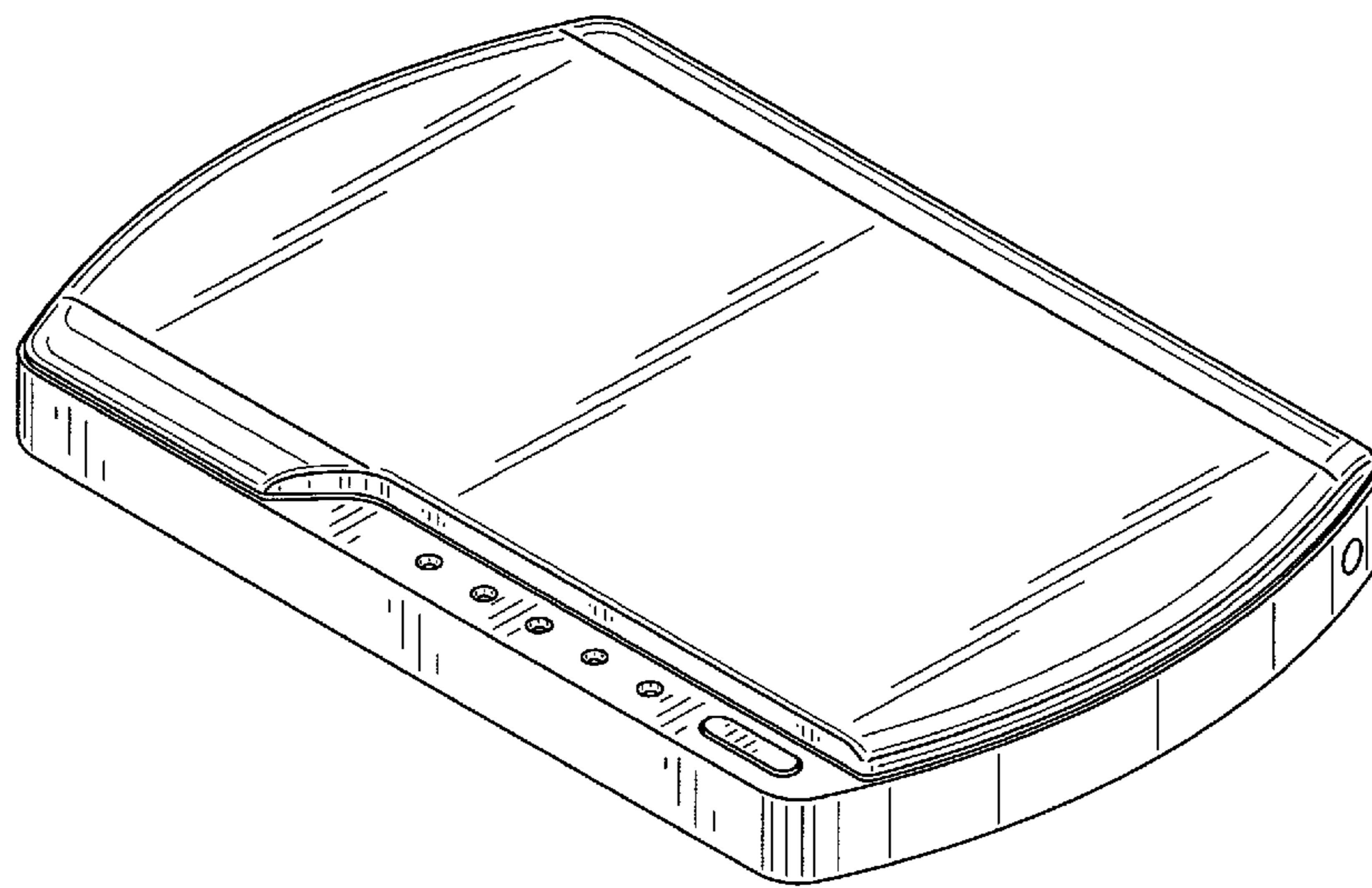

FIG. 1

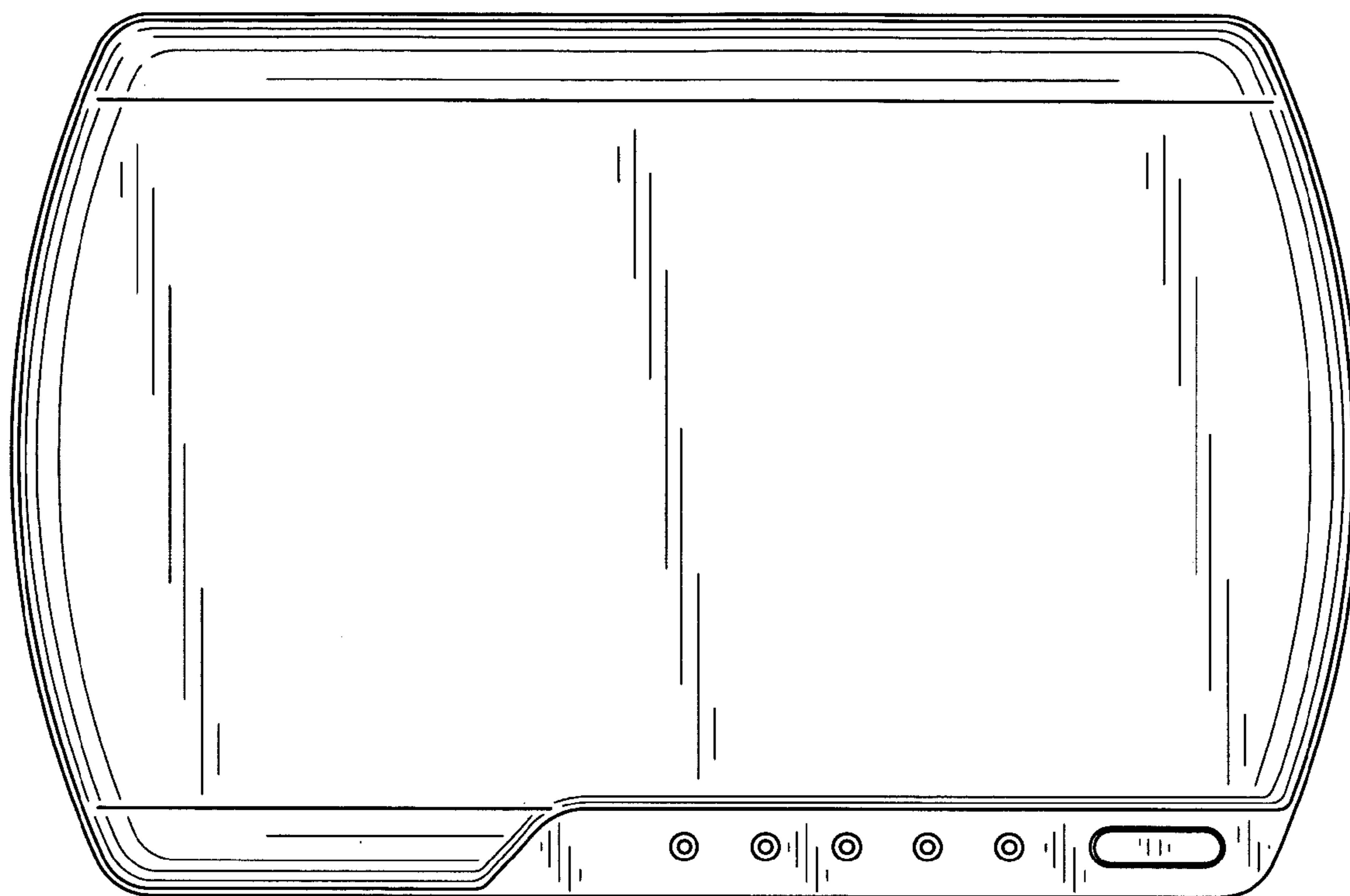

FIG. 2

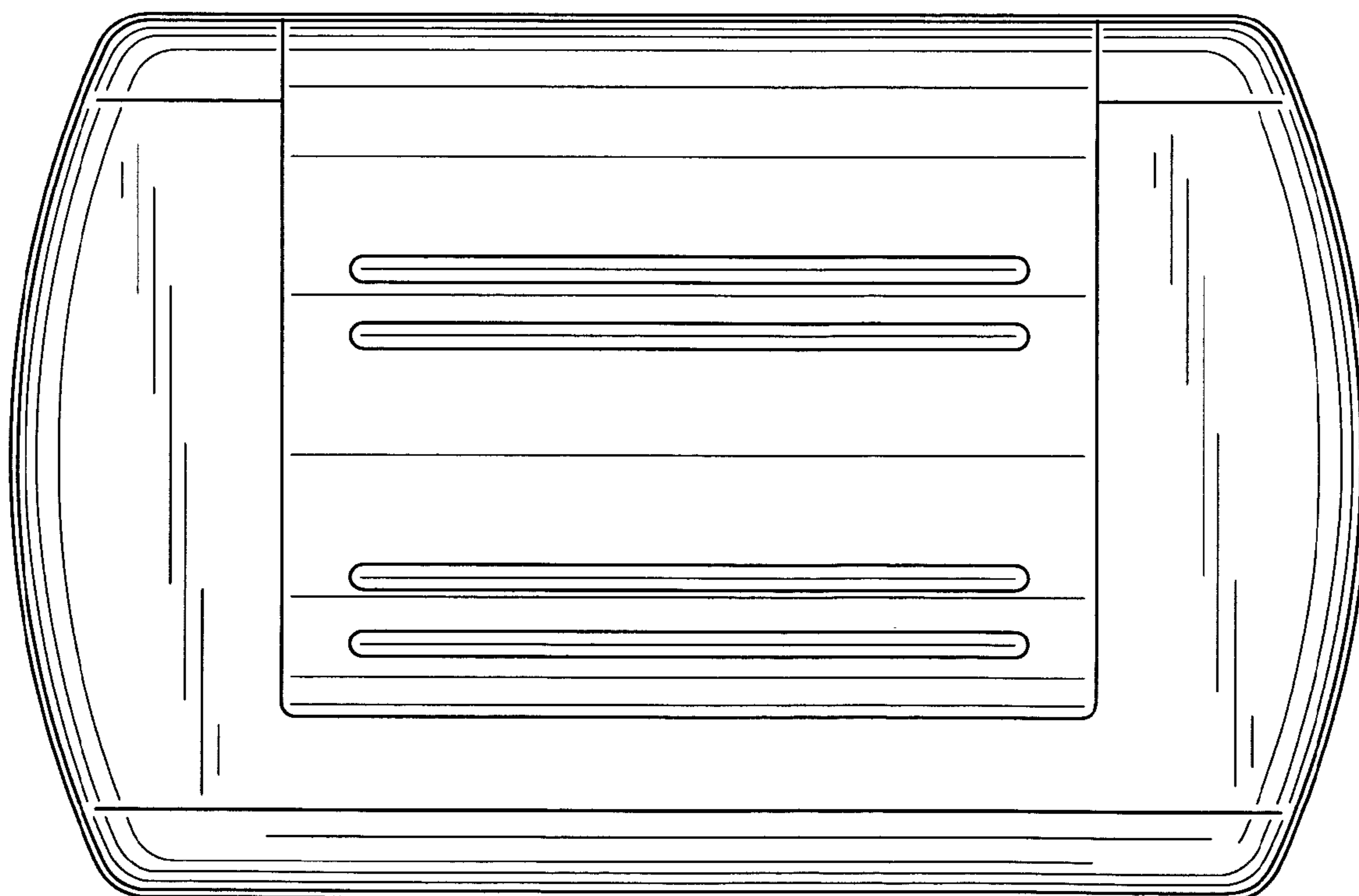

FIG. 3

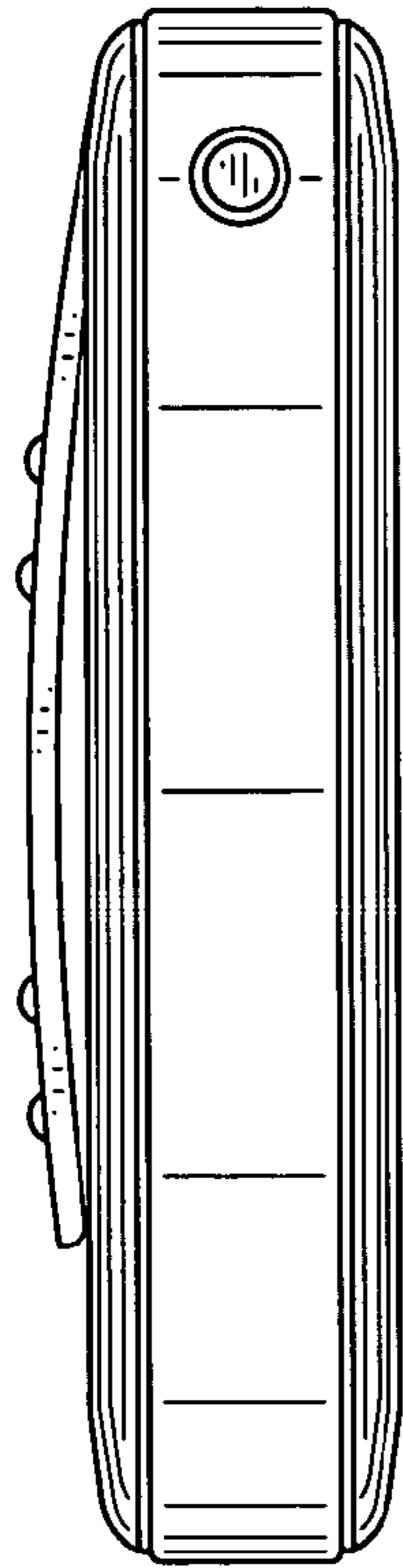

FIG. 4

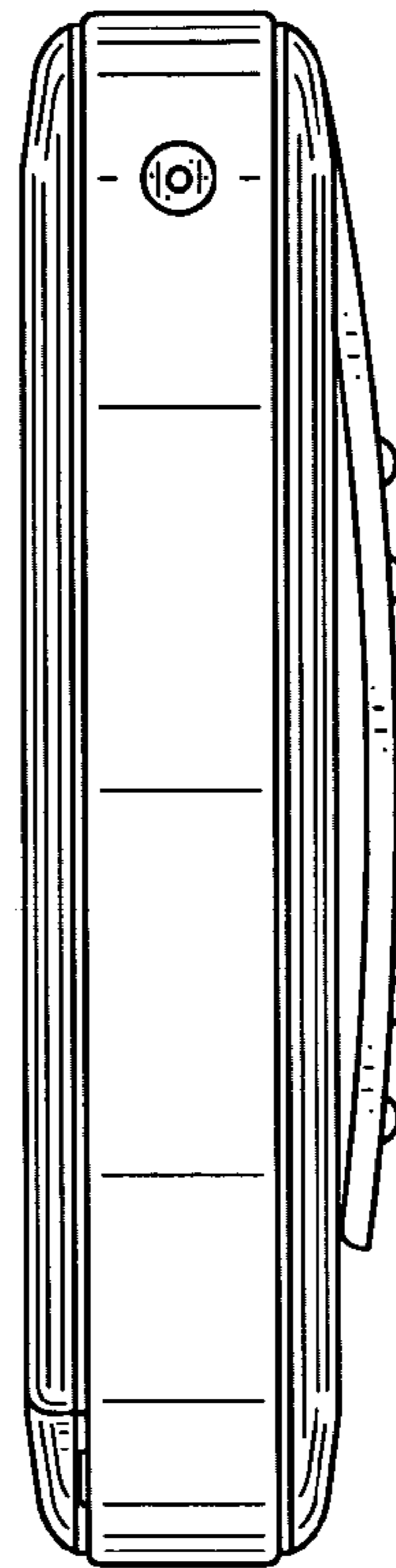

FIG. 5

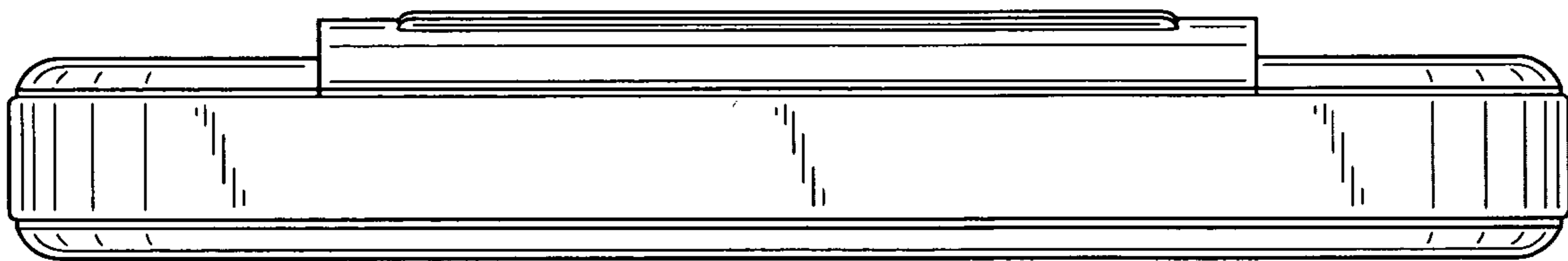

FIG. 6

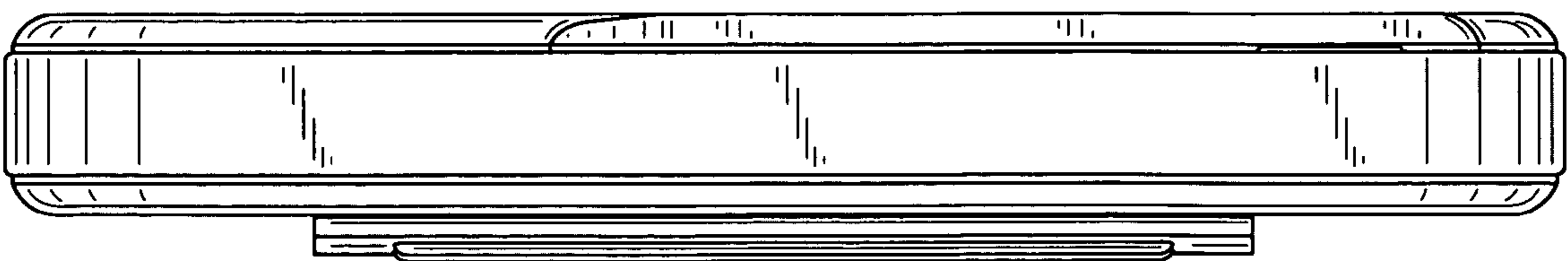

FIG. 7

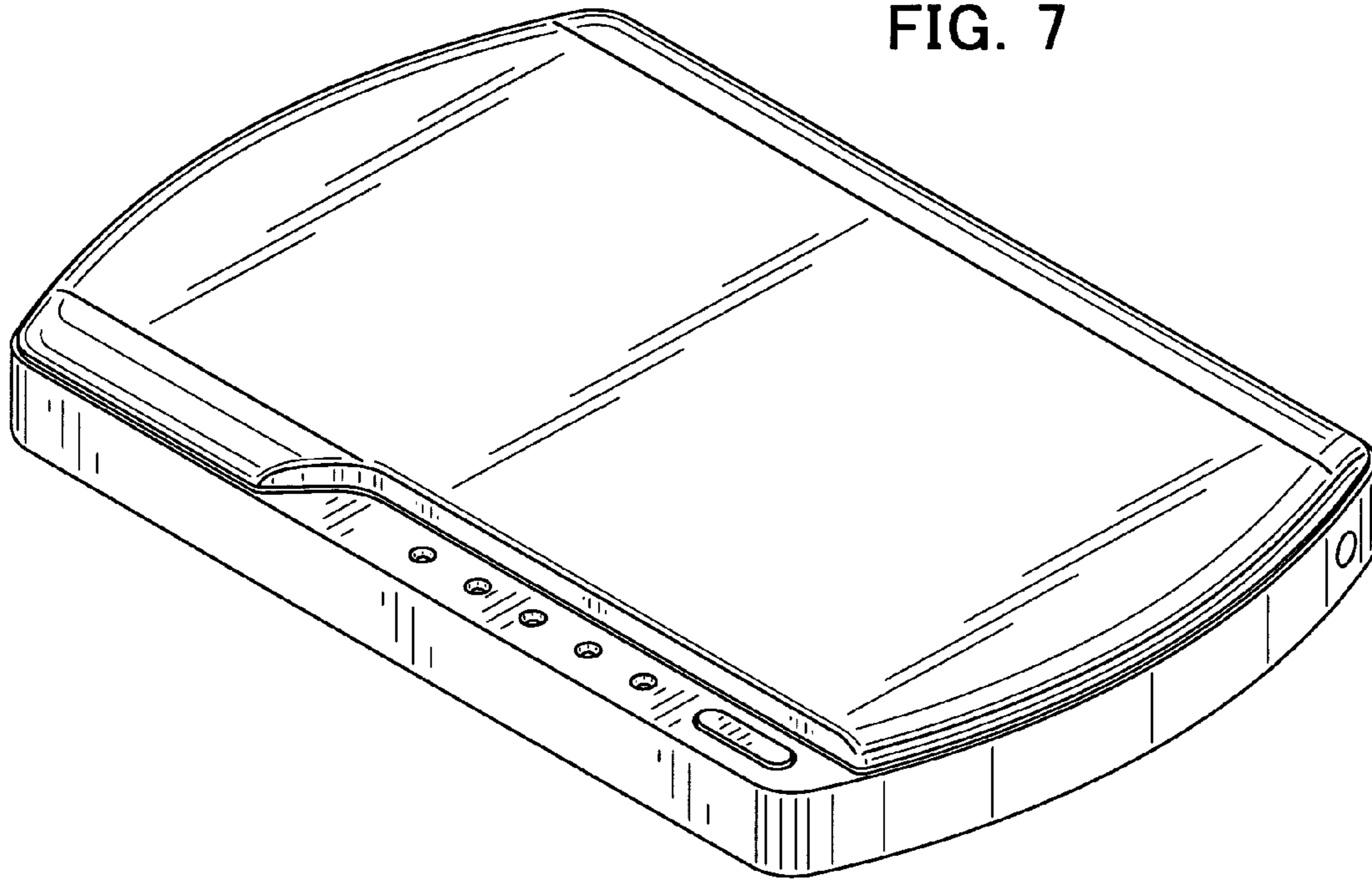

FIG. 8

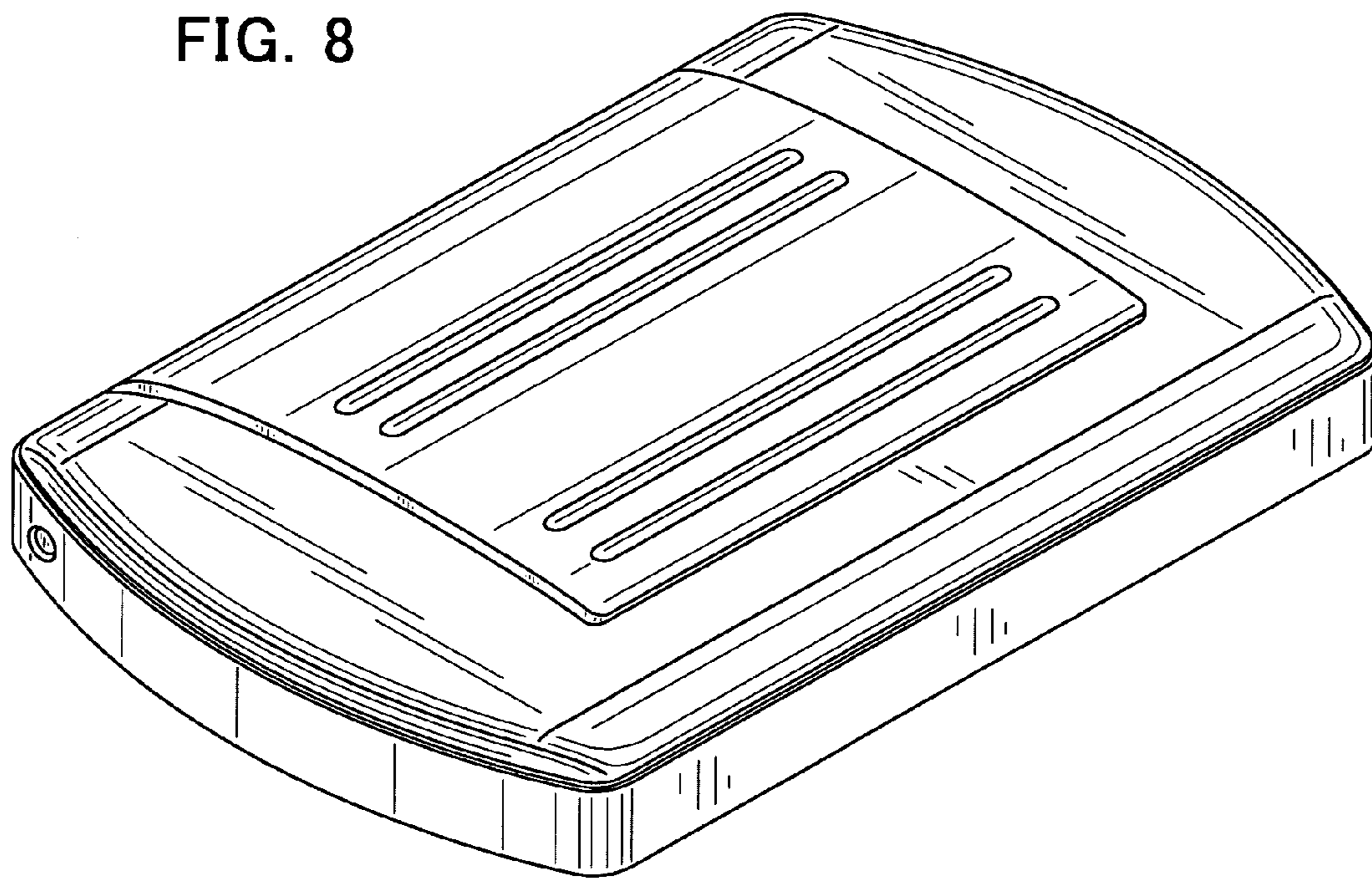

FIG. 9

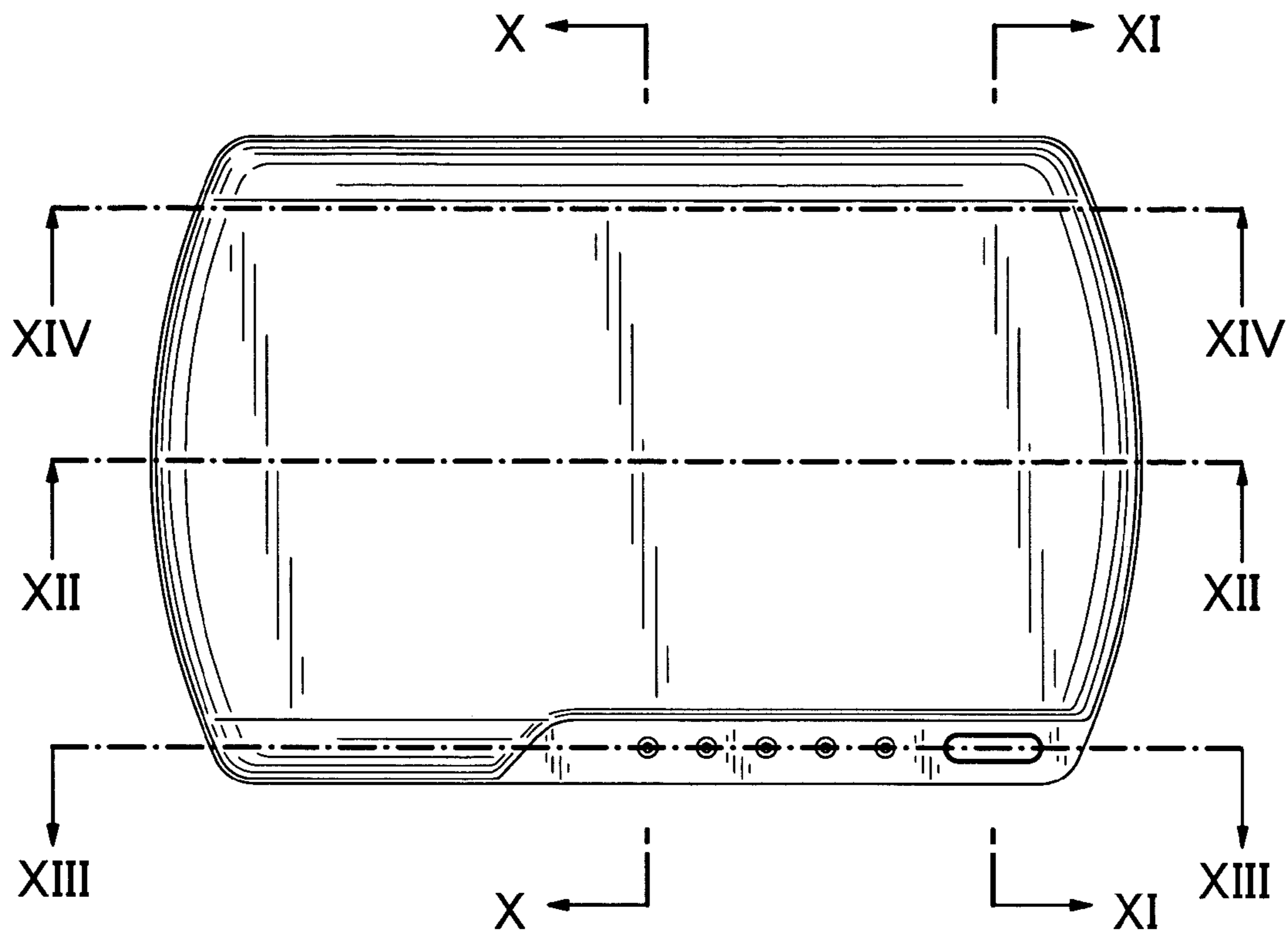

FIG. 10

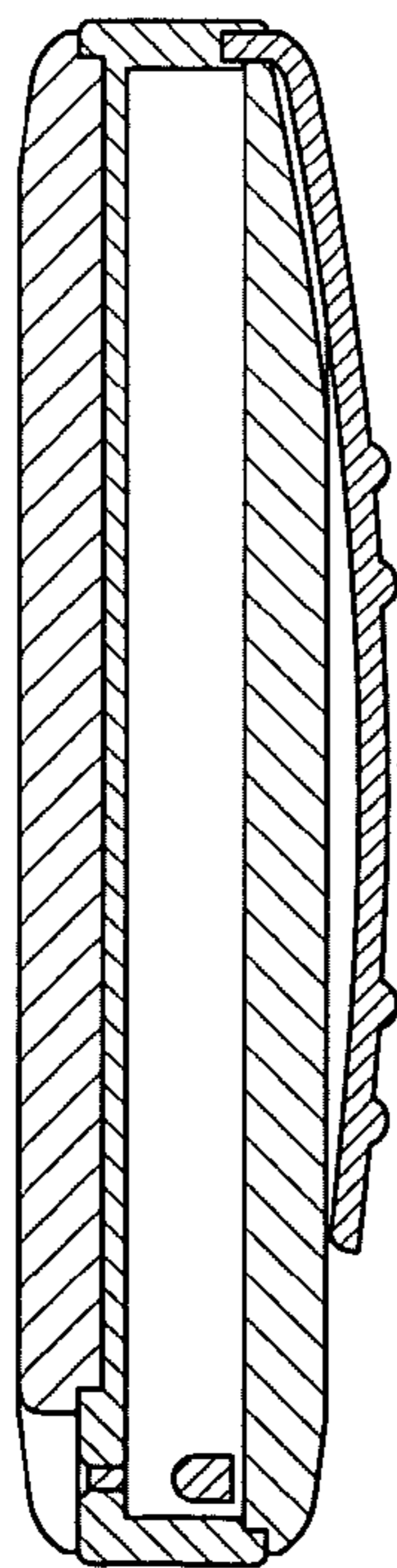

FIG. 11

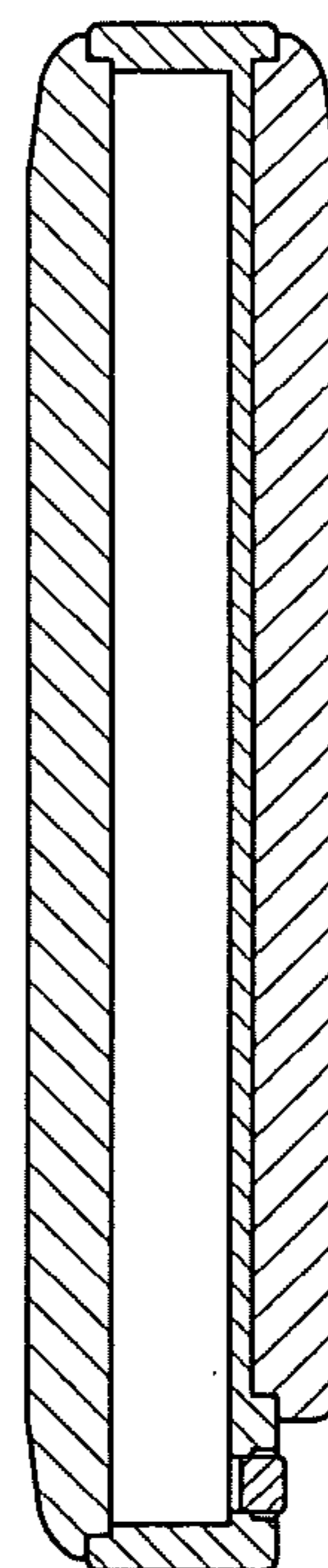

FIG. 12

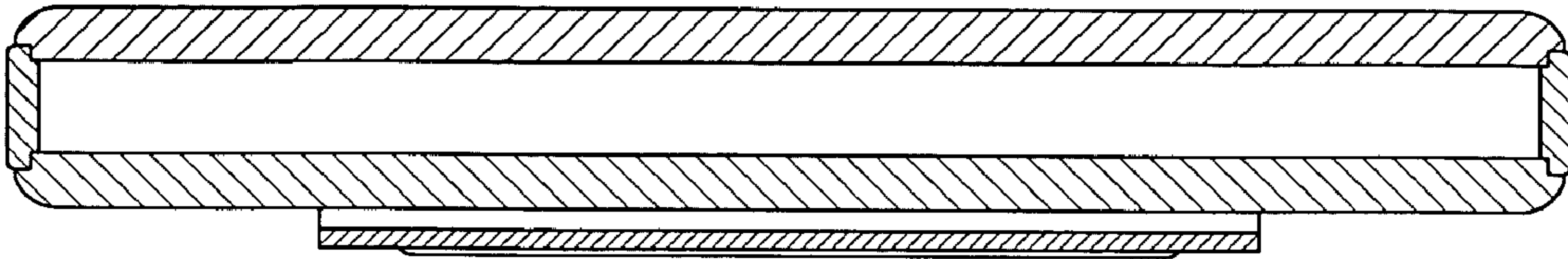

FIG. 13

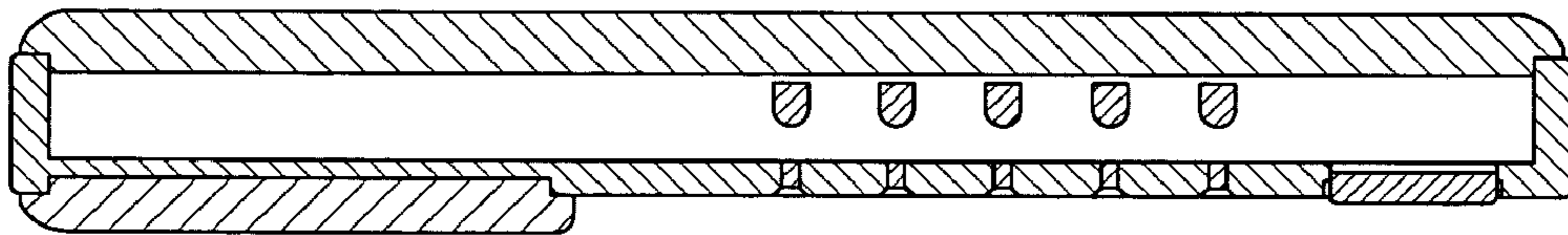

FIG. 14

