



US00D557561S

(12) **United States Design Patent**
Flowers et al.

(10) **Patent No.:** **US D557,561 S**
(45) **Date of Patent:** **** Dec. 18, 2007**

(54) **DOUBLE-WALLED CONTAINER**

4,399,919 A 8/1983 Posnansky et al.

(75) Inventors: **L'Anda Flowers**, Atlanta, GA (US);
Erika Gomez, Atlanta, GA (US);
Arsenio Garcia, Brooklyn, NY (US);
Goeran Jerstroem, Glen Ridge, NJ
(US); **Przemyslaw Godycki**, Brooklyn,
NY (US); **Melody Roberts**, Naperville,
IL (US)

(Continued)

FOREIGN PATENT DOCUMENTS

BE 1008405 A6 5/1996

(Continued)

(73) Assignee: **The Coca-Cola Company**, Atlanta, GA
(US)

Primary Examiner—Philip S. Hyder

Assistant Examiner—Cynthia Underwood

(**) Term: **14 Years**

(74) *Attorney, Agent, or Firm*—Sutherland Asbill &
Brennan LLP

(21) Appl. No.: **29/277,097**

(57) **CLAIM**

(22) Filed: **Feb. 13, 2007**

The ornamental design for a double-walled container, as
shown and described.

(51) **LOC (8) Cl.** **07-01**

(52) **U.S. Cl.** **D7/531; D7/523; D7/509**

(58) **Field of Classification Search** D7/396.1,
D7/396.2, 500, 509, 510, 511, 523, 524, 526–528,
D7/530–533, 536, 538, 540, 560, 565, 584;
D9/516, 519, 549, 555, 776, 778, 558; 215/387,
215/DIG. 7, 365, 382; 220/560, 592.17,
220/703; 229/400, 406

DESCRIPTION

See application file for complete search history.

FIG. 1 is a perspective view of our new double-walled
container, the broken lines representing portions of the
article that are not part of the design;

FIG. 2 is a side elevational view of one side of the double-
walled container of FIG. 1;

FIG. 3 is a side elevational view of another side of the
double-walled container of FIG. 1;

FIG. 4 is a side elevational view of yet another side of the
double-walled container of FIG. 1;

FIG. 5 is a side elevational view of yet another side of the
double-walled container of FIG. 1;

FIG. 6 is a top plan view of the double-walled container of
FIG. 1; and,

FIG. 7 is a bottom plan view of the double-walled container
of FIG. 1.

The broken line showing of the words Coca Cola is for
illustrative purposes only and forms no part of the claimed
design.

(56) **References Cited**

U.S. PATENT DOCUMENTS

723,796 A *	3/1903	Williams	220/592.17
D38,248 S *	9/1906	Helmer	D7/523
D42,683 S *	7/1912	Anderson	D7/531
D50,351 S *	2/1917	Heisey	D7/529
D67,869 S *	7/1925	Boswell	D7/523
1,712,552 A *	5/1929	Croom	215/382
1,968,263 A	7/1934	Reuther et al.		
2,863,585 A	12/1958	Meshberg		
2,895,636 A	7/1959	Martin		
3,225,954 A	12/1965	Herrick et al.		
3,295,709 A	1/1967	Herrick et al.		
3,635,380 A	1/1972	Fitzgerald		
3,661,288 A	5/1972	Noll		
D241,801 S *	10/1976	Colato	D7/531

1 Claim, 6 Drawing Sheets

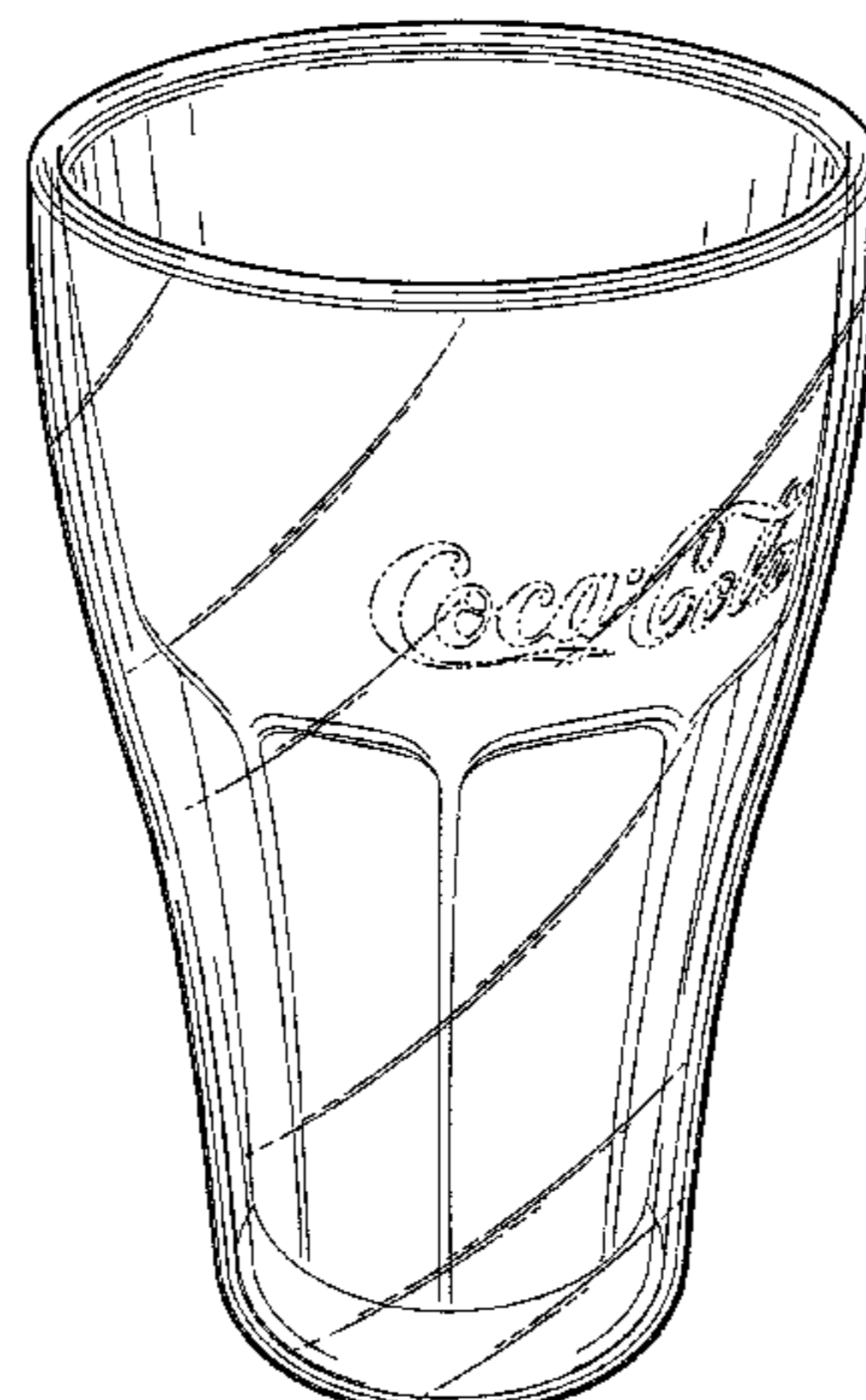

US D557,561 S

U.S. PATENT DOCUMENTS

4,570,454 A 2/1986 Campbell
 4,671,406 A 6/1987 Baer
 4,789,073 A 12/1988 Fine
 4,928,412 A 5/1990 Nishiyama
 4,941,590 A 7/1990 Pantaleo et al.
 5,001,907 A 3/1991 LaCroix et al.
 5,090,213 A 2/1992 Glassman
 5,150,815 A 9/1992 Saklad
 D339,267 S 9/1993 Hatt
 D356,523 S 3/1995 Rahr
 D356,978 S 4/1995 Rahr
 D356,979 S 4/1995 Rahr
 D358,115 S 5/1995 Rahr
 D358,356 S 5/1995 Rahr
 D363,854 S 11/1995 Katz
 5,553,735 A 9/1996 Kimura
 D376,071 S 12/1996 Ballin
 D380,647 S * 7/1997 Durand D7/531
 5,687,497 A 11/1997 Moore
 D392,842 S 3/1998 Parpaiola
 5,803,289 A * 9/1998 Brady 215/365
 D400,398 S 11/1998 McNaughton
 5,839,599 A 11/1998 Lin
 D402,158 S 12/1998 Mountain, Jr. et al.
 5,890,621 A 4/1999 Bachman et al.
 5,894,948 A 4/1999 Yeh
 5,913,442 A 6/1999 Wu
 6,000,985 A 12/1999 Yeh
 6,010,027 A 1/2000 Fujii et al.
 6,050,443 A 4/2000 Tung
 D428,307 S * 7/2000 Yeandel D7/531
 6,105,814 A 8/2000 Chen
 D430,777 S 9/2000 Husted
 6,119,889 A 9/2000 Fujii et al.
 6,164,469 A 12/2000 Sartore
 6,241,095 B1 6/2001 Yencheng
 6,253,918 B1 7/2001 Greiner
 D451,031 S * 11/2001 Westphal D9/558
 6,325,211 B1 12/2001 Greiner
 D452,797 S 1/2002 Palefsky et al.
 6,334,271 B1 1/2002 Su Yeh
 6,352,168 B1 3/2002 Lin
 D457,395 S 5/2002 Gluck
 6,386,387 B1 5/2002 Hwang
 6,398,019 B1 6/2002 Cheng
 6,405,892 B1 6/2002 Volan
 D459,949 S 7/2002 Brennan
 6,419,108 B1 7/2002 Toida et al.
 D461,368 S 8/2002 Durand
 D462,293 S 9/2002 Bates et al.
 D462,294 S 9/2002 Walsh
 D462,295 S 9/2002 Bates et al.
 D462,296 S 9/2002 Bates et al.
 6,464,078 B1 10/2002 Grossnickle
 6,467,644 B1 10/2002 Yeh
 6,511,196 B1 1/2003 Hoy
 6,516,548 B2 2/2003 Lage et al.
 D471,404 S 3/2003 Gady
 D477,184 S 7/2003 Latapi
 6,619,811 B2 9/2003 Wang et al.
 D480,267 S 10/2003 Freed et al.
 D480,590 S 10/2003 Linz et al.
 D483,981 S 12/2003 Linz et al.
 D484,362 S 12/2003 Harris et al.
 D488,672 S 4/2004 Oas
 6,905,043 B2 6/2005 Zilberman
 6,913,165 B2 7/2005 Linz et al.
 6,915,917 B2 7/2005 Watanabe et al.
 6,921,179 B2 7/2005 Diak Ghanem
 6,923,549 B2 8/2005 Hoy
 D509,409 S 9/2005 Harris et al.

6,962,264 B2 11/2005 Zilberman
 7,003,906 B1 2/2006 Yang
 7,007,819 B2 3/2006 Pollack
 D519,785 S 5/2006 Bodum
 D526,848 S * 8/2006 Bodum D7/523
 2003/0024895 A1 2/2003 Meyers et al.
 2004/0173559 A1 9/2004 Shih
 2004/0212120 A1 10/2004 Giraud
 2005/0045643 A1 3/2005 Ghanem
 2005/0111212 A1 5/2005 Diak/Ghanem
 2005/0157487 A1 7/2005 Epstein
 2005/0173365 A1 8/2005 McKnight
 2005/0194340 A1 9/2005 Huang
 2006/0102582 A1 5/2006 Wakefield et al.

FOREIGN PATENT DOCUMENTS

CN 2367195 Y 3/2000
 CN 2394494 Y 9/2000
 CN 2620513 Y 6/2004
 CN 1553873 12/2004
 CN 3448684 5/2005
 CN 3450383 6/2005
 DE 157659 3/1904
 DE 493137 2/1930
 DE 9414715.9 12/1994
 DE 29810745 U1 11/1998
 DE M9306489.6 6/1999
 DE 20103678 U1 6/2001
 DE 40204660.9 1/2003
 DE M9703967.5 2/2003
 DE M9704621.3 3/2003
 DE M9709357.2 8/2003
 DE 49902644.6 11/2004
 DE 40501896.7 10/2005
 DE 40005808.1 3/2006
 DE 40104733.4 4/2006
 DE 202006004466 U1 7/2006
 EP 0089428 A1 9/1983
 EP 037688 9/1996
 EP 0667483 B1 10/1998
 EP 546281 2/1999
 EP 0945096 A1 9/1999
 EP 0958198 B1 11/1999
 EP 0963727 A2 12/1999
 EP 054954 1/2001
 EP 0717949 B1 4/2002
 EP 1034730 B1 5/2003
 EP 1318084 A1 6/2003
 EP 1422165 B1 5/2004
 EP 000206545-0001 7/2004
 EP 000206545-0002 9/2004
 EP 000232749-0001 9/2004
 EP 000219647-0003 11/2004
 EP 000219647-0005 11/2004
 EP 1484162 A1 12/2004
 EP 000308283-0001 5/2005
 EP 000423835-0001 12/2005
 EP 000440359-0004 1/2006
 EP 000440359-0005 1/2006
 EP 000440359-0006 1/2006
 EP 000491303-0002 3/2006
 EP 000491303-003 3/2006
 EP 000478268-0006 4/2006
 EP 000478268-0007 4/2006
 EP 000478268-0008 4/2006
 EP 000478268-0010 4/2006
 EP 000491303-0004 5/2006
 EP 000491303-0005 5/2006
 EP 000531868-0002 6/2006
 ES 125479 U 3/1967
 ES 138110 U 10/1968
 ES 0201569 U 10/1975

US D557,561 S

ES	0214873 U	7/1976	FR	546 279 A 546 290	7/1999
ES	0278995 U	12/1984	FR	2775574	5/2000
ES	1001010 U	4/1988	FR	622 695 A 622 703	2/2001
ES	1008506 U	4/1989	FR	622700	3/2001
ES	1015162 U	6/1991	FR	668909 ET 668910	7/2002
ES	1027987 U	11/1994	FR	680400 A 680402	11/2002
ES	1028736 U	3/1995	FR	746665 A 746667	2/2005
ES	1031268 U	12/1995	FR	748414 A 748420	3/2005
ES	1034425 U	1/1997	FR	748550	3/2005
ES	I0141051	12/1997	GB	1021252	3/1966
ES	100498IU	10/1998	GB	1122663	8/1968
ES	1040665 U	5/1999	GB	1495386	12/1977
ES	2222327 T	2/2005	GB	2032876 A	5/1980
ES	D0502076-01	6/2006	GB	2057249 A	4/1981
ES	D0502076-02	6/2006	GB	2122874 A	1/1984
ES	D0502076-03	6/2006	GB	2167648 A	9/1984
ES	D0502076-04	6/2006	GB	2372935 A	9/2002
ES	D0502076-05	6/2006	IT	213393	11/1989
ES	D0502076-06	6/2006	IT	0055465	3/1991
ES	D0502076-07	6/2006	IT	0216235	6/1991
FR	1406118	6/1965	IT	00235844	7/2000
FR	1544776	11/1968	IT	0000086746	12/2001
FR	1600577	9/1970	IT	00079476	7/2002
FR	157277 A 157289	9/1976	WO	81/02282	2/1980
FR	158360 A 158369	11/1976	WO	98/45208	10/1998
FR	2295826	3/1979	WO	99/44481	9/1999
FR	197897	12/1981	WO	00/10434	3/2000
FR	196345	1/1982	WO	02/32769 A2	4/2002
FR	283766	8/1990	WO	02/49924 A2	6/2002
FR	288605 A 288610	11/1990	WO	02/049924 A3	6/2002
FR	564397 ET 564398	12/1991	WO	02/074140 A1	9/2002
FR	0354571 A 0354575	2/1994	WO	03/096850 A1	11/2003
FR	0354586 A 0354590	2/1994	WO	2005/075319 A1	8/2005
FR	0401800 ET 040180	7/1995	WO	2005/107537 A1	11/2005
FR	2709652	9/1995	WO	2006/005002 A2	1/2006
FR	440694	10/1996	WO	2006/040543 A1	4/2006
FR	044601	7/1998			
FR	546280	2/1999			

* cited by examiner

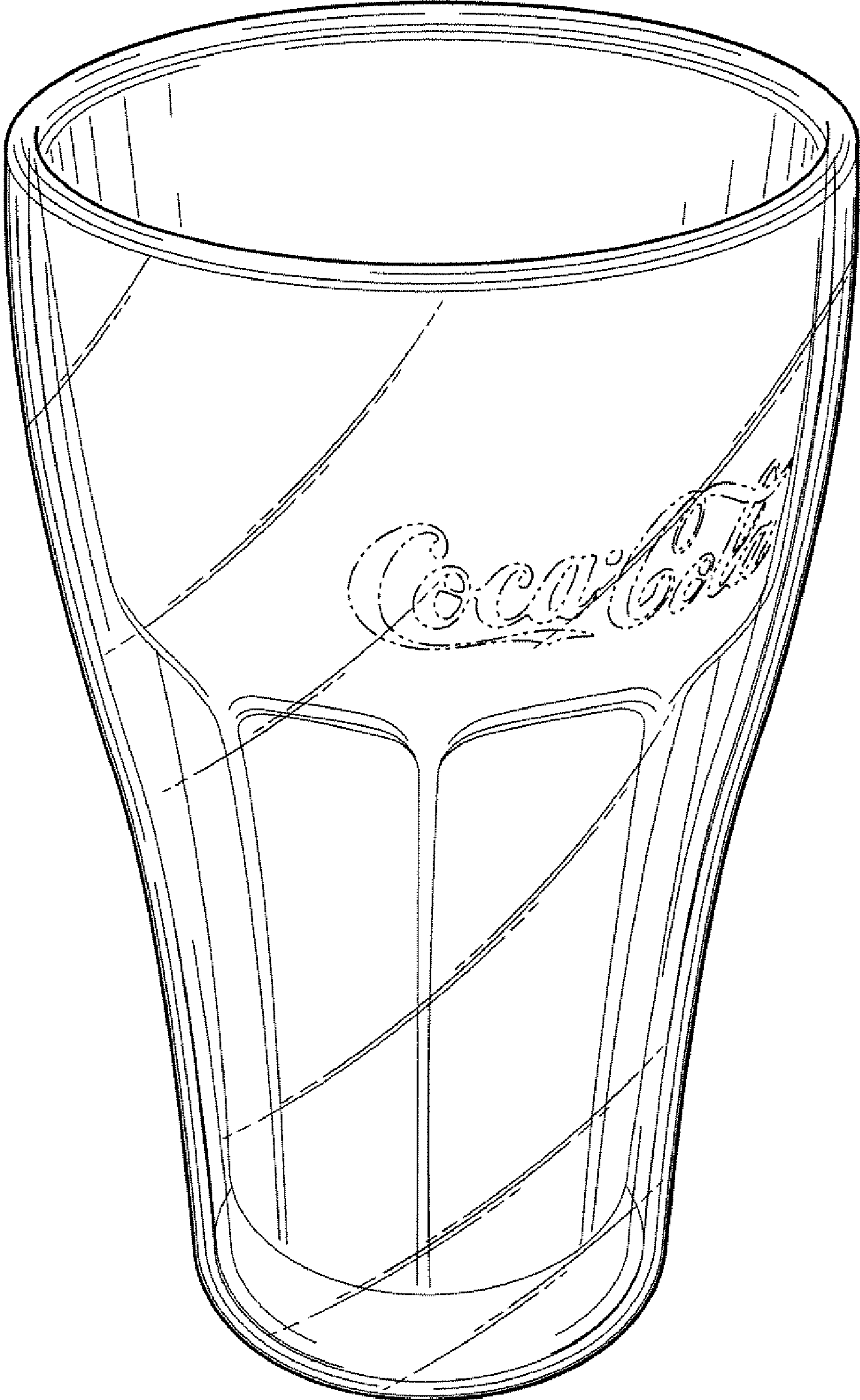

Fig. 1

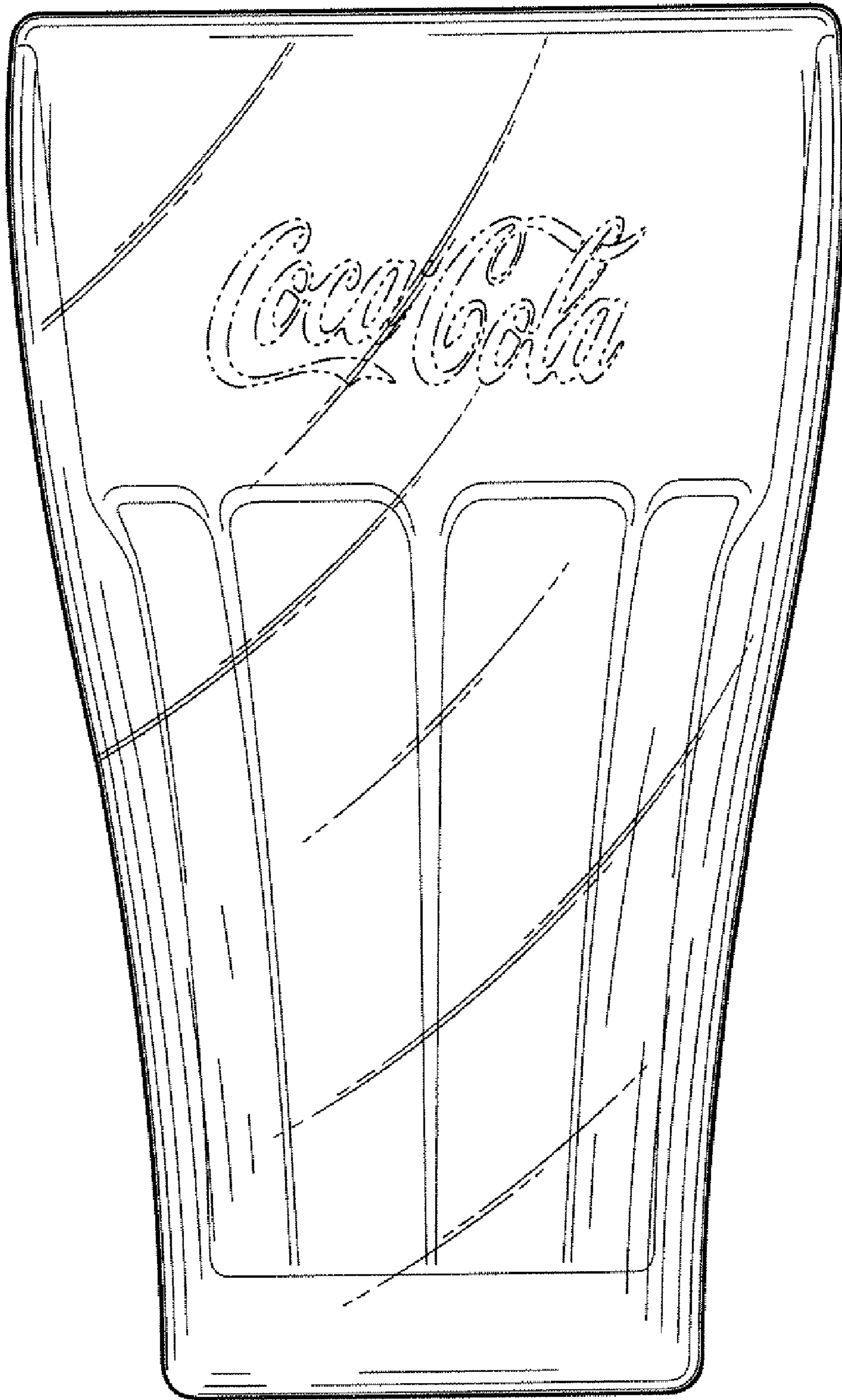

Fig. 2

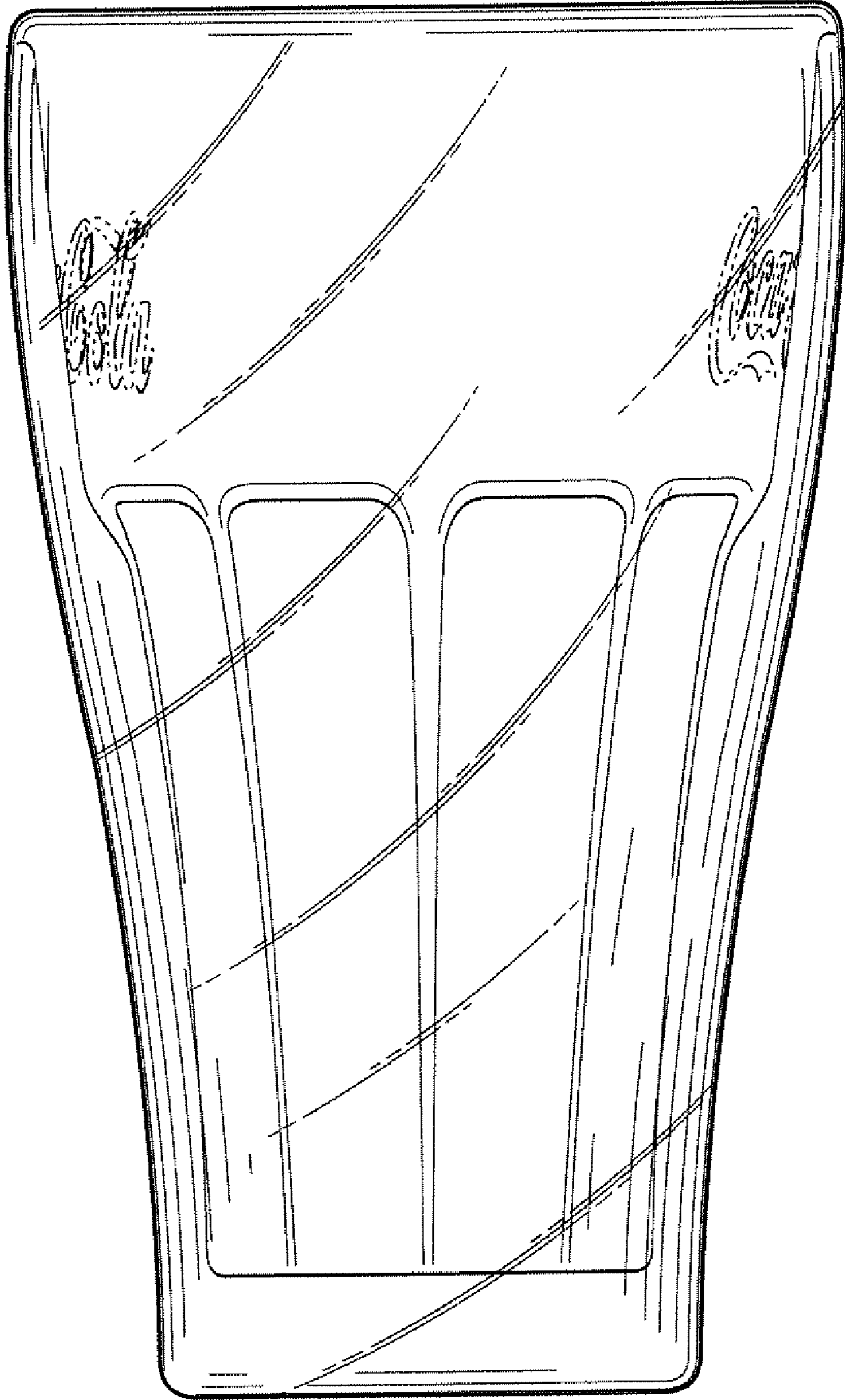

Fig. 3

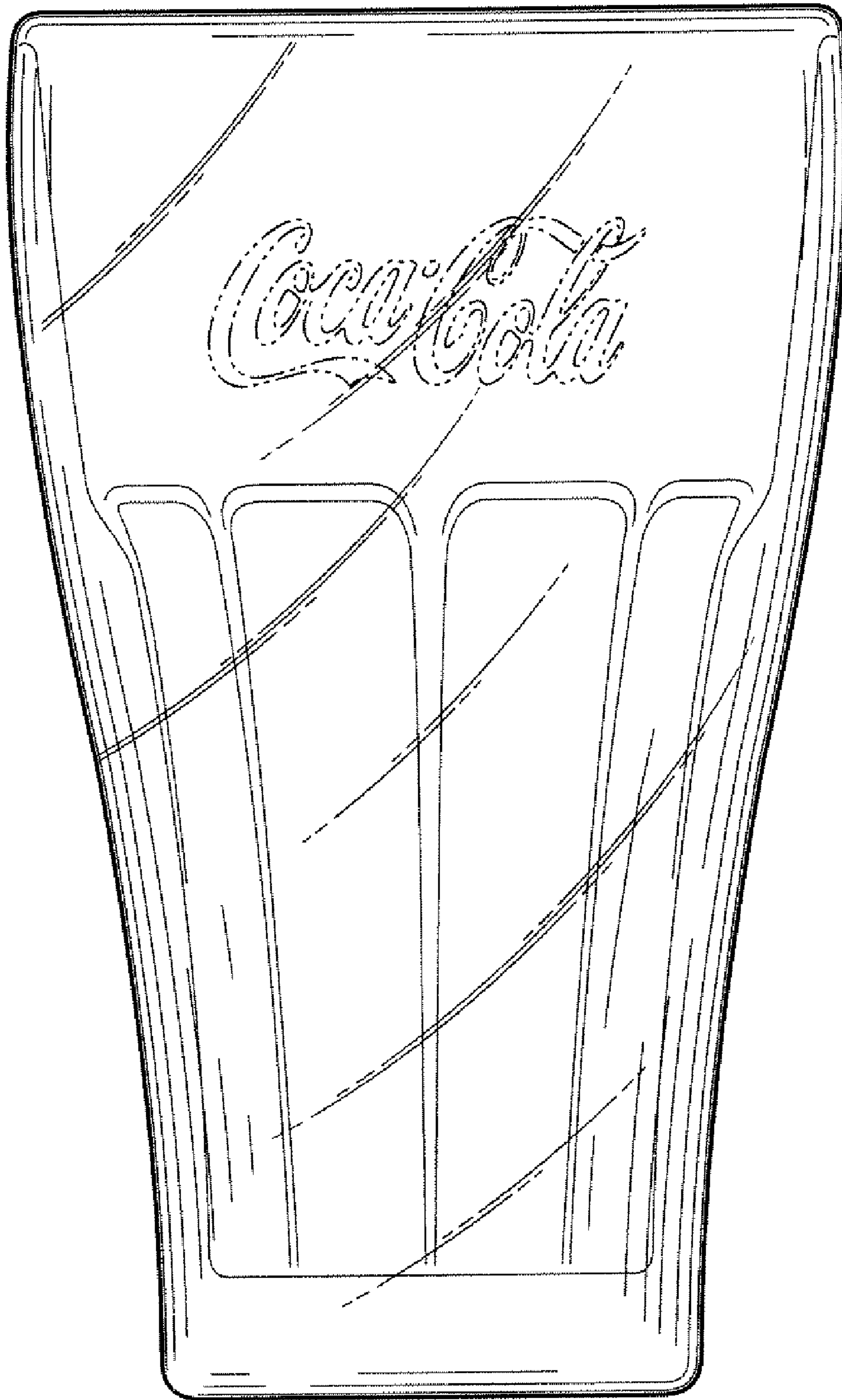

Fig. 4

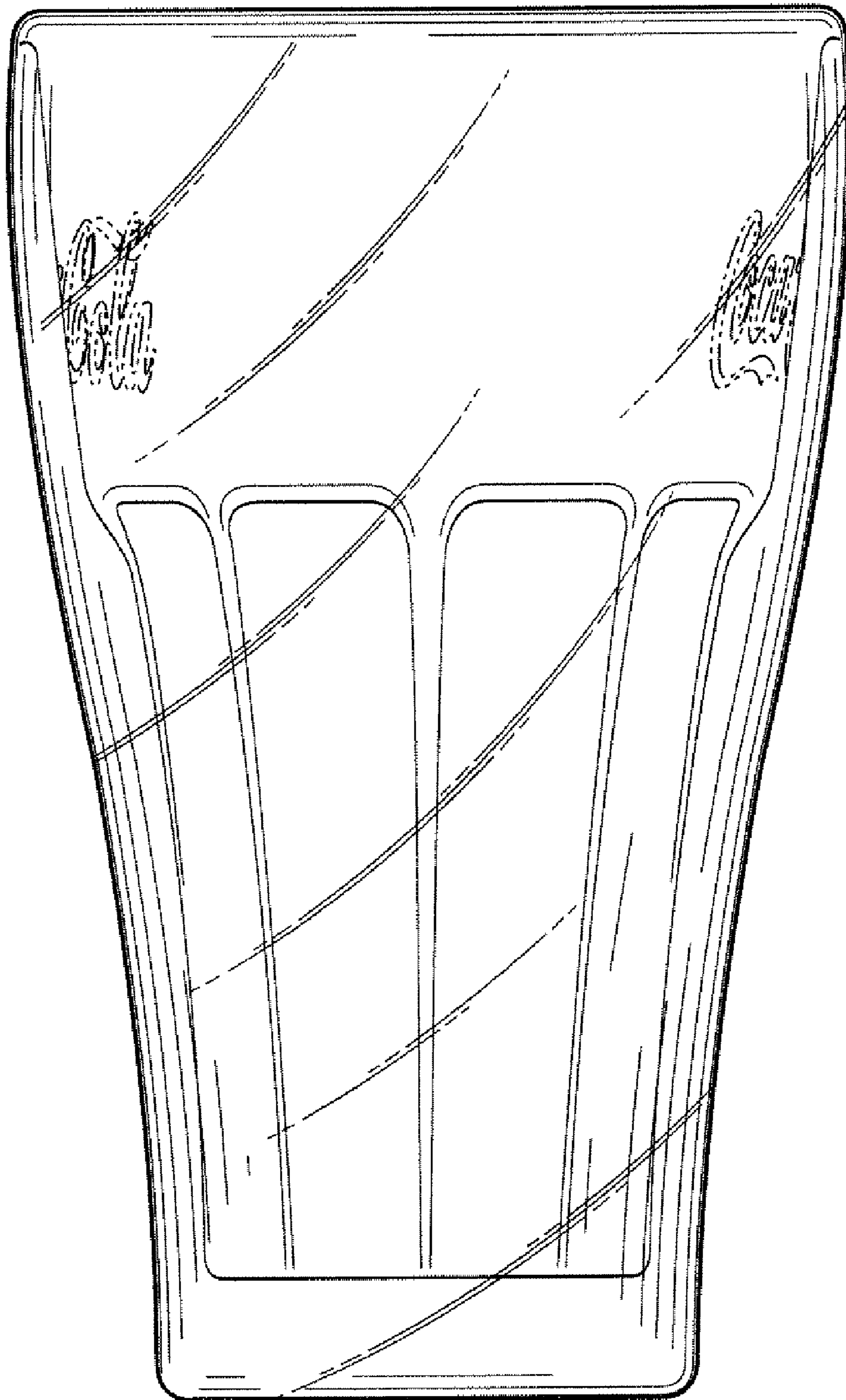

Fig. 5

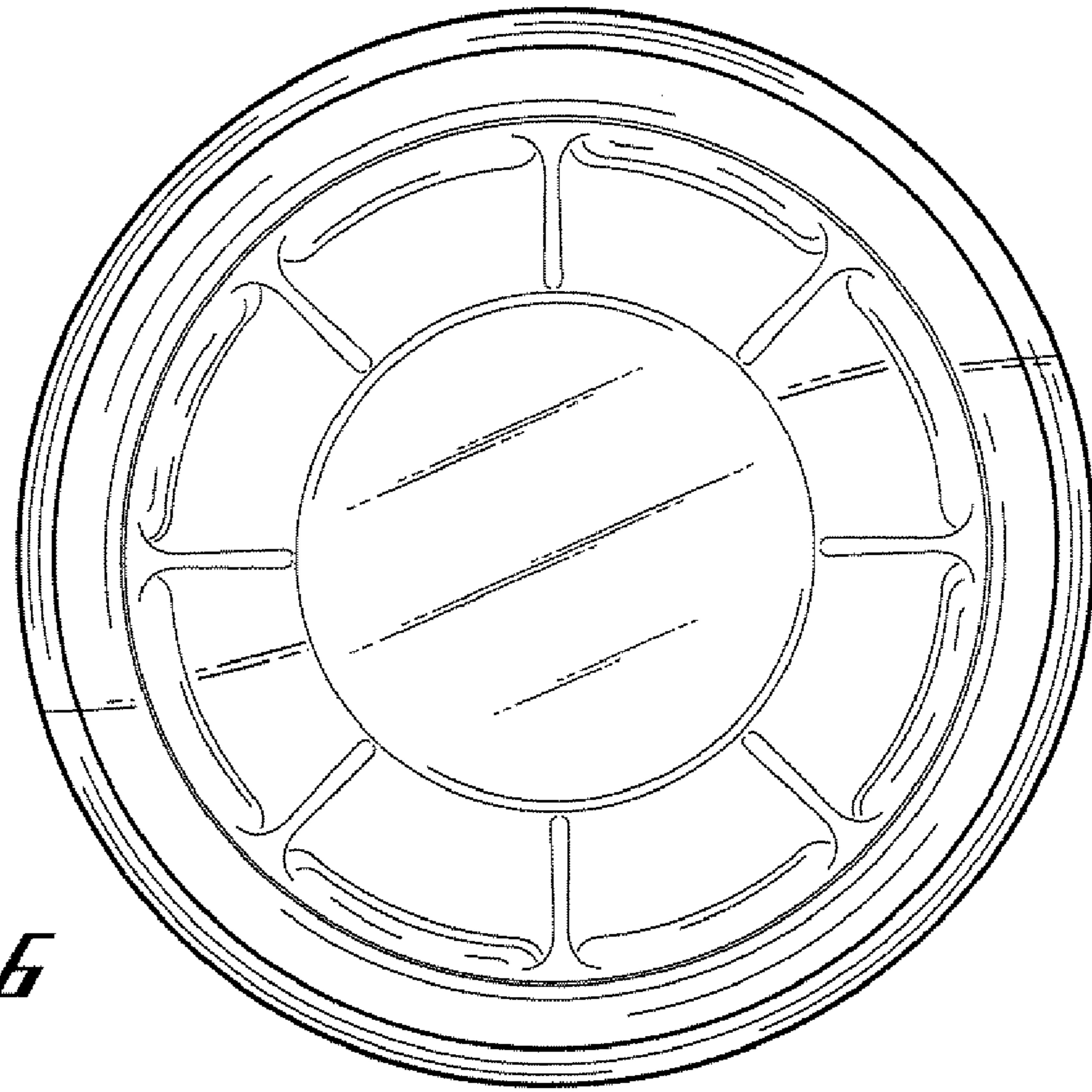

Fig. 6

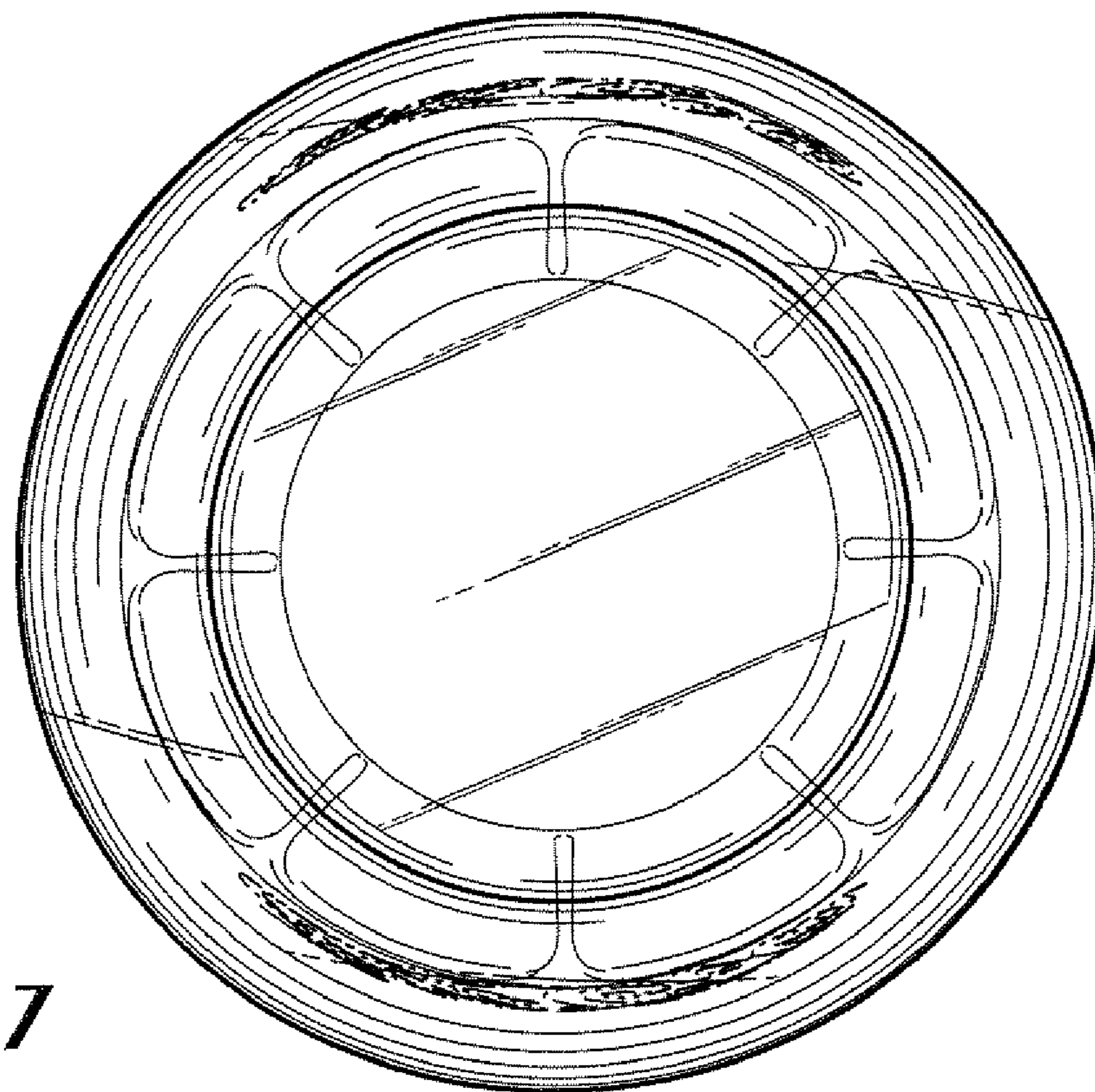

Fig. 7