



US00D557496S

(12) **United States Design Patent**
Gonthier

(10) **Patent No.:** **US D557,496 S**

(45) **Date of Patent:** **** Dec. 18, 2007**

(54) **TRAVEL POCKET**

(76) Inventor: **Hugh Eugene Gonthier**, 9226 Phelan Rd., Phelan, CA (US) 92371

(**) Term: **14 Years**

(21) Appl. No.: **29/279,860**

(22) Filed: **May 9, 2007**

(51) **LOC (8) Cl.** **03-01**

(52) **U.S. Cl.** **D3/226; D3/222; D3/231**

(58) **Field of Classification Search** D3/218,
D3/222-223, 231, 215; 224/192-193, 198,
224/911-912, 603, 253, 581-583, 624, 605,
224/901.4, 901.8; D2/627

See application file for complete search history.

(56) **References Cited**

U.S. PATENT DOCUMENTS

D371,457 S * 7/1996 Jacobs D3/231
D414,332 S * 9/1999 Brechard D3/231
D449,735 S * 10/2001 Nielsen D3/222

D524,042 S * 7/2006 Lavine D3/218
D547,943 S * 8/2007 Menzel D3/222

* cited by examiner

Primary Examiner—Catherine R. Oliver

(57) **CLAIM**

The ornamental design for travel pocket, as shown and described.

DESCRIPTION

FIG. 1 is a perspective view of a travel pocket, showing my new design;

FIG. 2 is a right-side elevational view of the invention;

FIG. 3 is a left-side elevational view of the invention;

FIG. 4 is a rear elevational view of the invention;

FIG. 6 is a front elevational view of the invention;

FIG. 6 is a top plan view of the invention; and,

FIG. 7 is a bottom plan view of the invention.

1 Claim, 2 Drawing Sheets

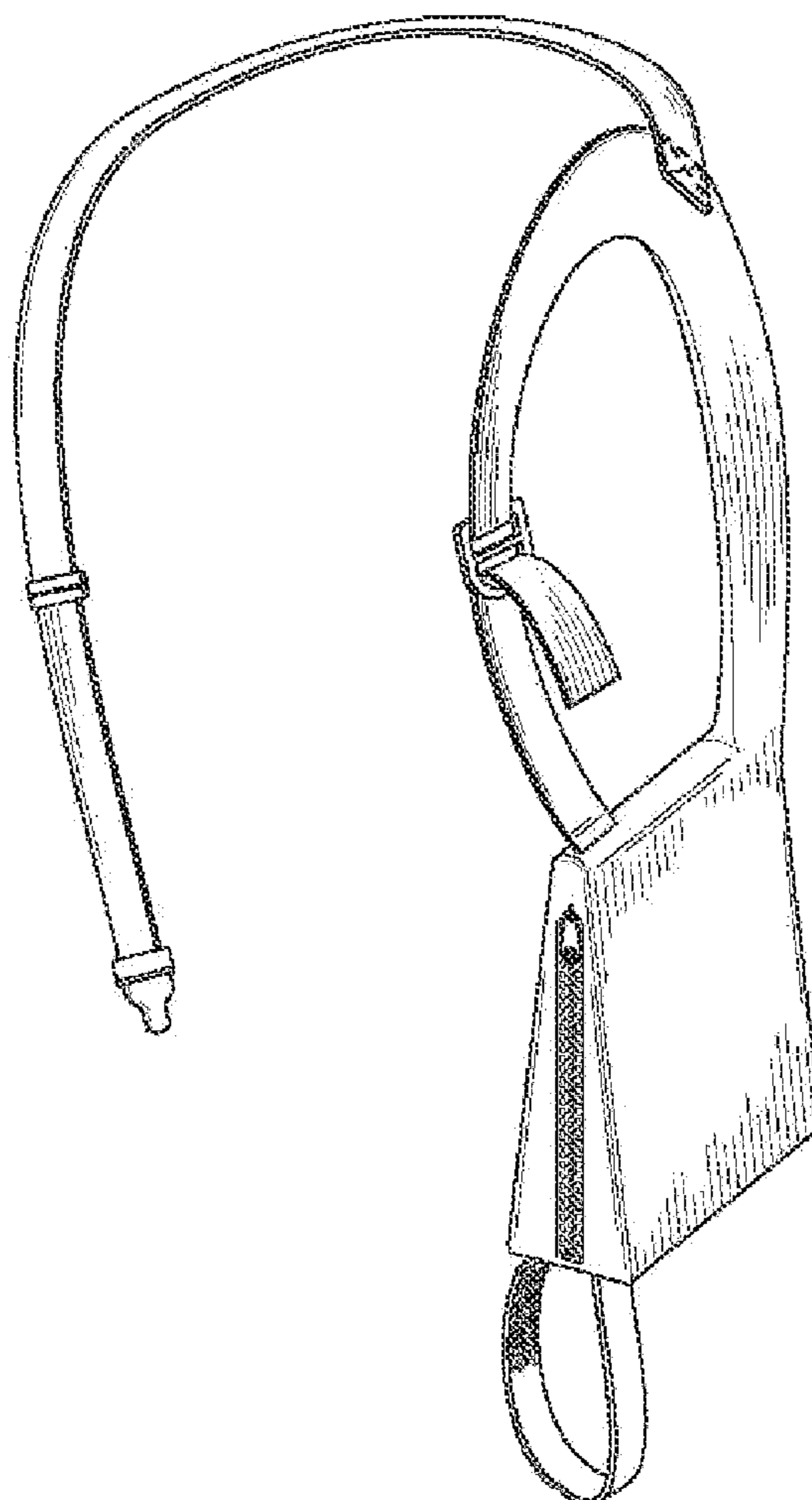

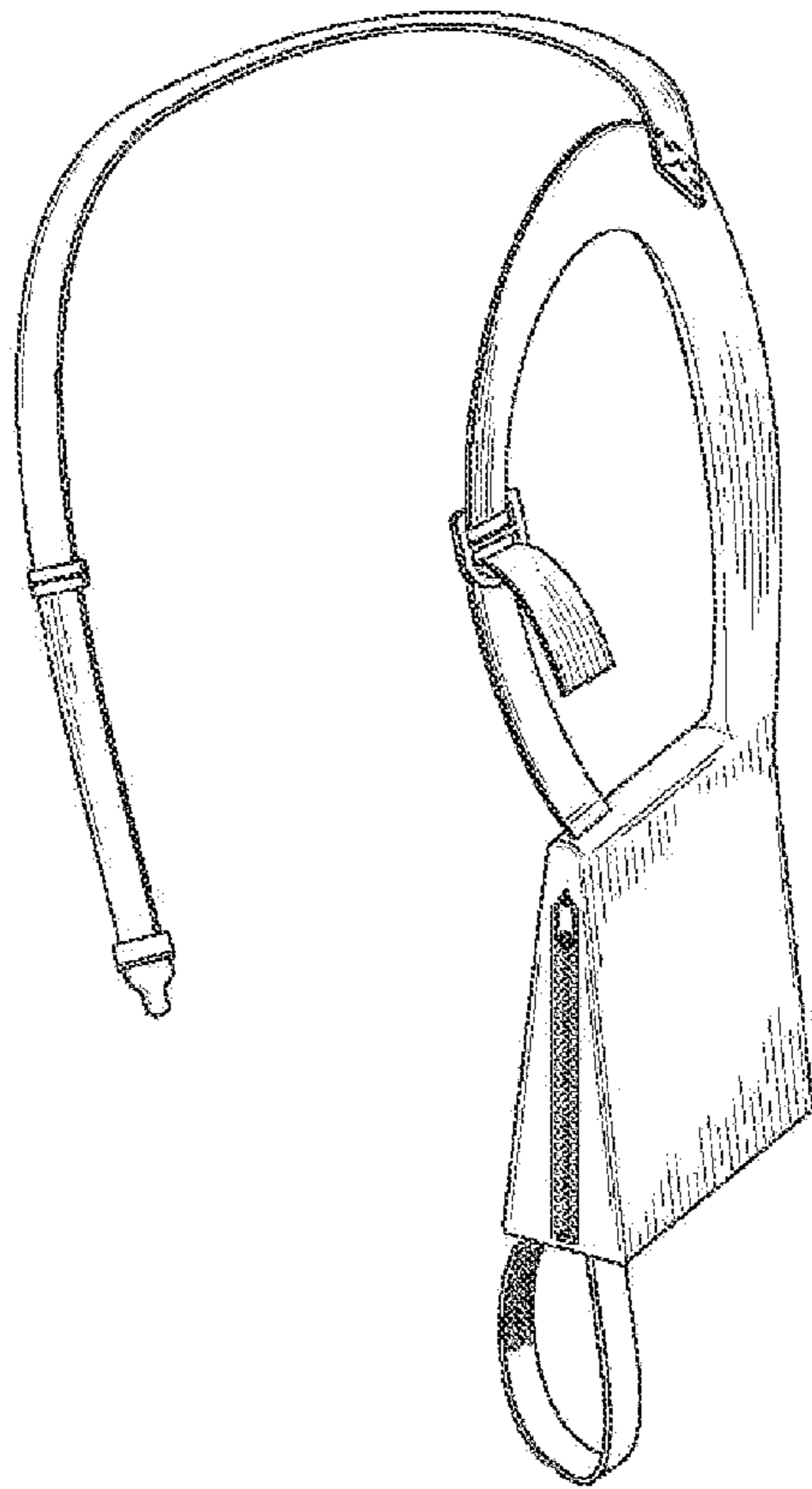

FIG. 1

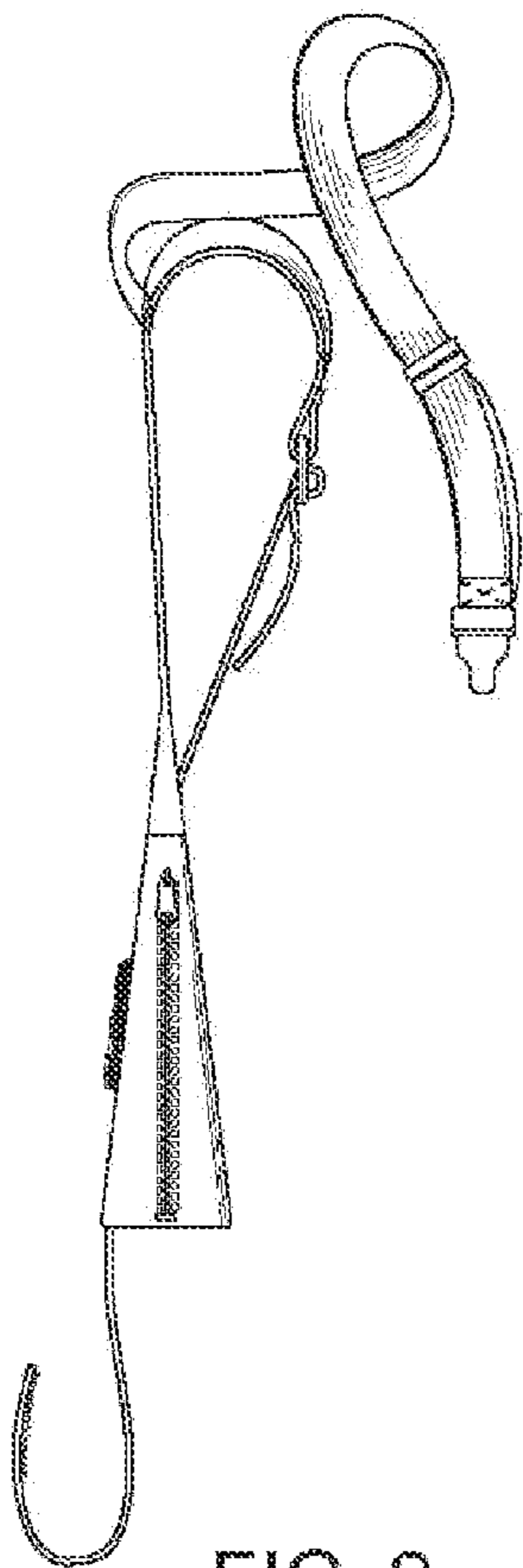

FIG. 2

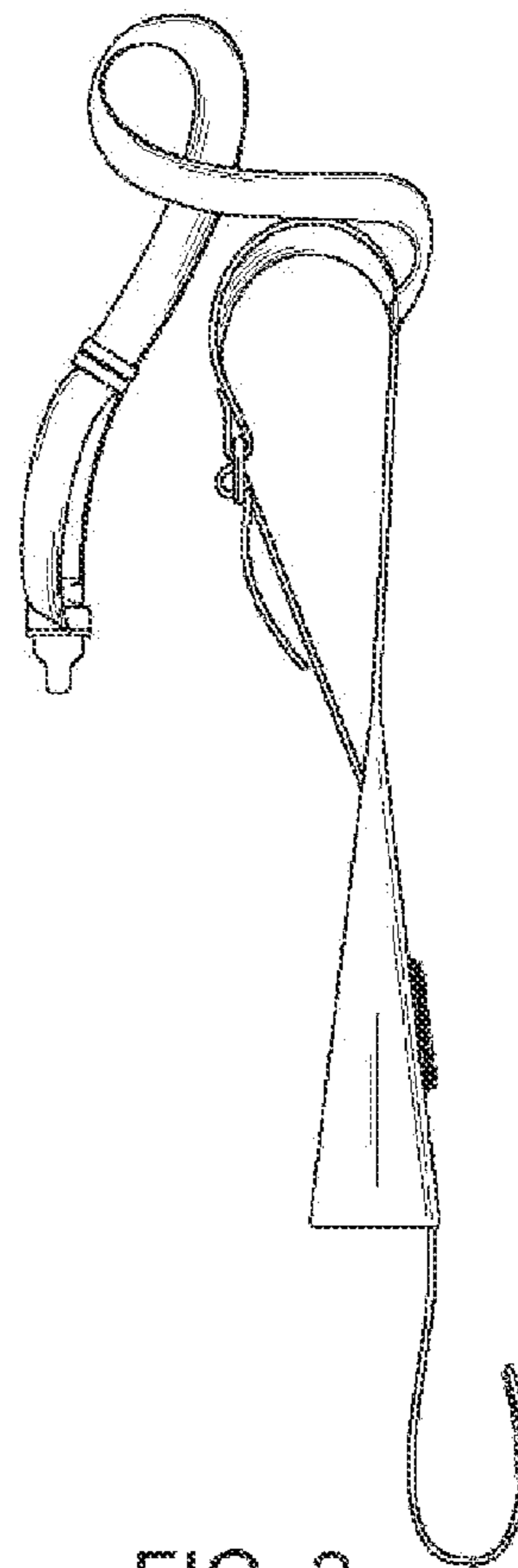

FIG. 3

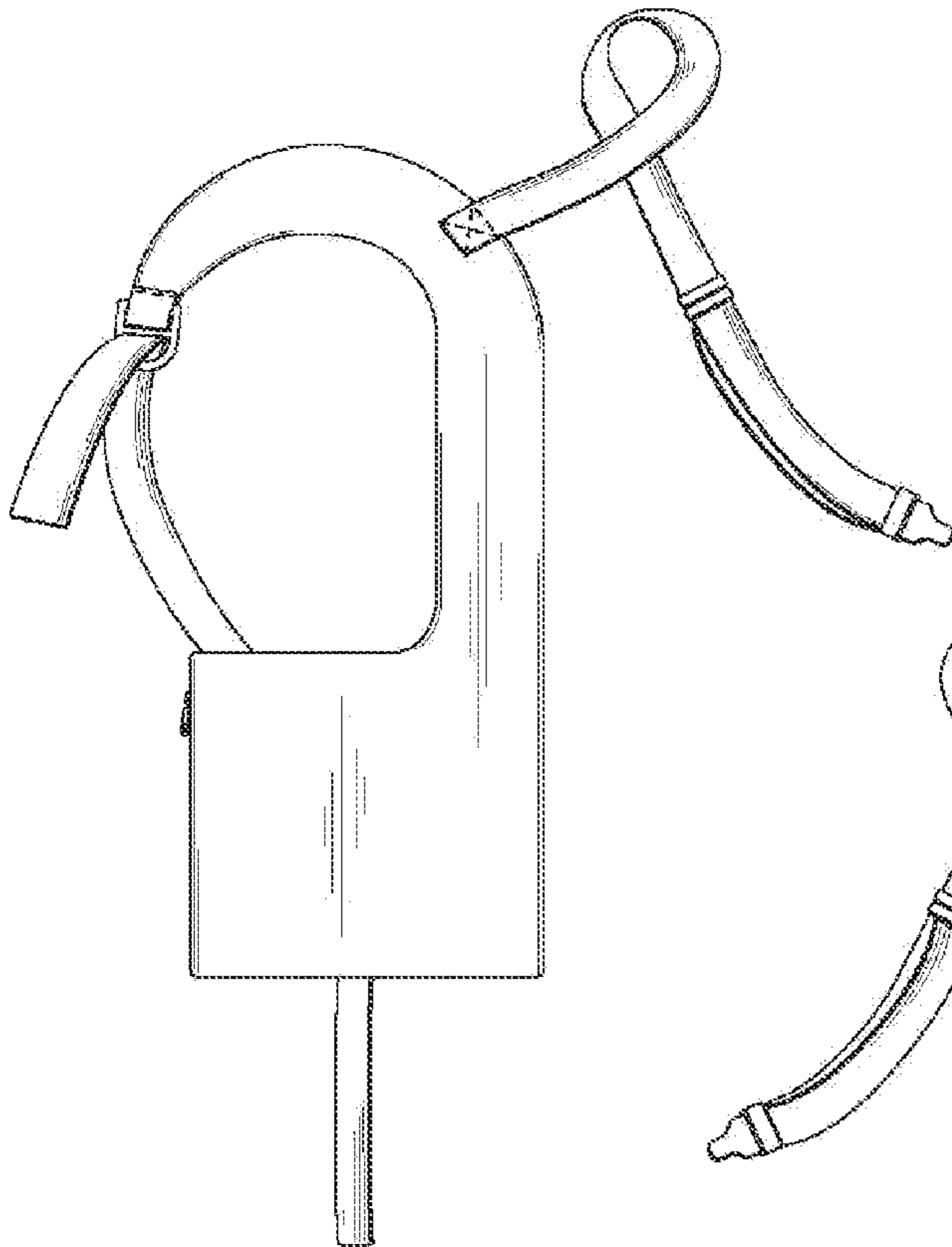

FIG. 4

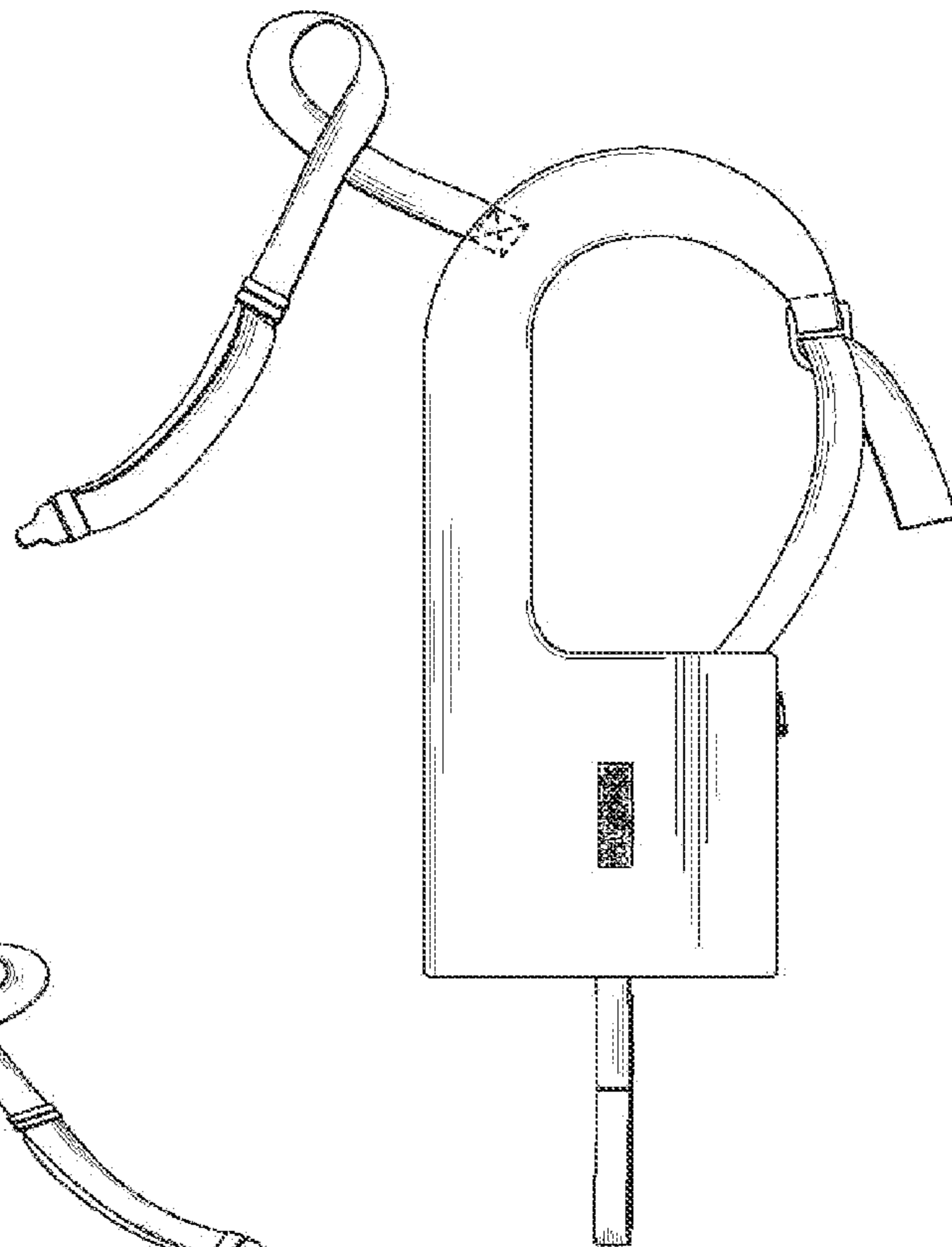

FIG. 5

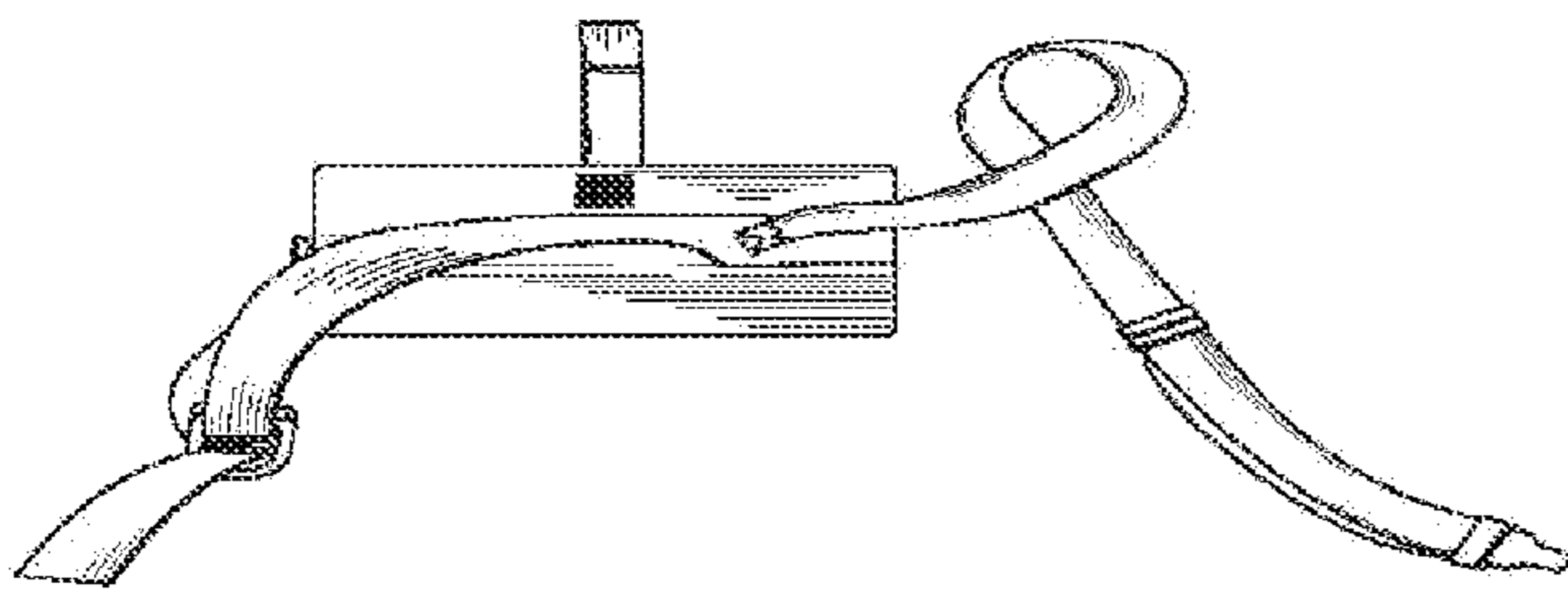

FIG. 6

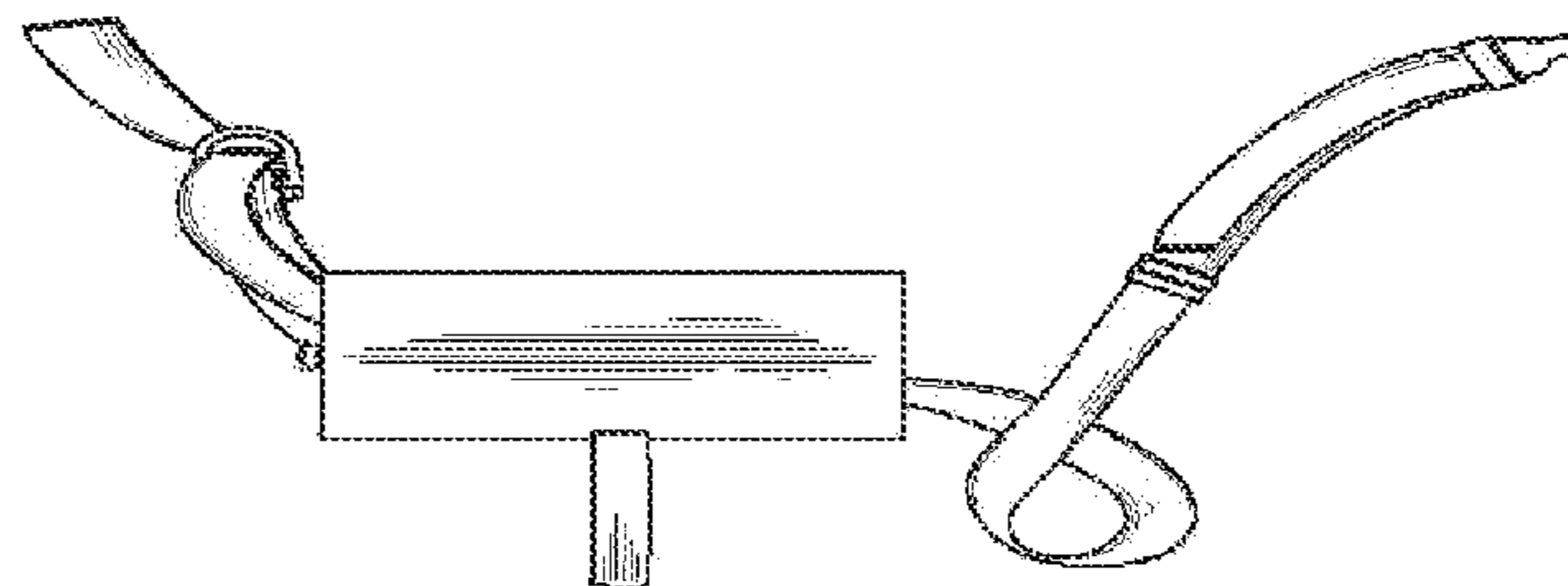

FIG. 7