



US00D557451S

(12) **United States Design Patent**
McDowell

(10) **Patent No.:** **US D557,451 S**

(45) **Date of Patent:** **** Dec. 11, 2007**

(54) **LAMPSHADE**

(75) Inventor: **Mark McDowell**, Davie, FL (US)

(73) Assignee: **Blumberg Industries, Inc.**, Miami Lakes, FL (US)

(**) Term: **14 Years**

(21) Appl. No.: **29/270,779**

(22) Filed: **Jan. 3, 2007**

Related U.S. Application Data

(62) Division of application No. 29/214,854, filed on Oct. 8, 2004, now Pat. No. Des. 539,971.

(51) **LOC (8) Cl.** **26-99**

(52) **U.S. Cl.** **D26/118**

(58) **Field of Classification Search** D26/123,
D26/124, 113, 118, 137, 142, 119, 128, 153,
D26/72, 85, 105; 362/363, 317, 351, 355,
362/356, 358, 223, 362

See application file for complete search history.

(56) **References Cited**

U.S. PATENT DOCUMENTS

| | | | |
|---------------|---------|----------------|---------|
| 41,547 A | 2/1864 | Stratton | |
| 249,690 A | 11/1881 | Swift | |
| D69,320 S | 1/1926 | Hall | |
| 1,586,577 A | 6/1926 | Raitt | |
| 1,955,684 A * | 4/1934 | Rezofsky | 362/444 |
| D114,108 S * | 4/1939 | Manning | D26/112 |
| 2,230,186 A * | 1/1941 | Andrews et al. | 362/291 |
| 2,538,676 A * | 1/1951 | Enright | 362/352 |
| 2,637,805 A | 5/1953 | Jacobs | 240/108 |
| 2,711,476 A | 6/1955 | Wells | 240/108 |
| 2,713,632 A * | 7/1955 | Fine | 362/357 |
| D201,295 S | 6/1965 | Robichaud | D48/16 |
| 3,222,517 A | 12/1965 | Peter | 240/108 |
| 3,239,662 A * | 3/1966 | Noller | 250/296 |
| D204,899 S * | 5/1966 | Curry | D26/105 |
| D218,474 S | 8/1970 | Devine | D48/16 |
| 3,666,934 A | 5/1972 | Moore | 240/3 |
| D226,327 S * | 2/1973 | Anderson | D26/67 |

| | | | |
|-------------------|---------|-----------------|----------|
| D244,875 S * | 6/1977 | Baca | D26/105 |
| D246,269 S | 11/1977 | Baker | D48/16 R |
| 4,079,245 A | 3/1978 | Baker | 362/355 |
| 4,233,656 A | 11/1980 | Shemitz | 362/352 |
| 4,290,099 A | 9/1981 | Vicars-Harris | 362/352 |
| 4,344,115 A | 8/1982 | Pickens et al. | 362/216 |
| D287,107 S * | 12/1986 | Bergeron et al. | D10/121 |
| D294,645 S * | 3/1988 | Ewing et al. | D26/67 |
| 4,731,716 A | 3/1988 | Chang | 362/352 |
| D298,861 S | 12/1988 | Ewing et al. | D26/71 |
| D323,037 S | 1/1992 | Edwards | D26/118 |
| D345,024 S | 3/1994 | Fox | D26/58 |
| 5,375,048 A * | 12/1994 | Barnes | 362/352 |
| D377,402 S * | 1/1997 | Perkins | D26/135 |
| D385,650 S * | 10/1997 | Okros | D26/120 |
| D396,319 S | 7/1998 | Sutton | D26/128 |
| D416,099 S | 11/1999 | Hardy | D26/9 |
| D417,026 S | 11/1999 | Taylor et al. | D26/67 |
| 6,000,817 A | 12/1999 | Chan | 362/352 |
| D429,360 S | 8/2000 | Chelf et al. | D26/86 |
| D434,518 S | 11/2000 | Rivers | D26/110 |
| D438,327 S | 2/2001 | Chelf et al. | D26/80 |
| D447,272 S | 8/2001 | Smith | D26/118 |
| D463,613 S | 9/2002 | Block | D26/142 |
| 6,474,831 B1 * | 11/2002 | Ruuttu et al. | 362/148 |
| 6,537,063 B1 * | 3/2003 | Pecoskie | 431/324 |
| D477,892 S | 7/2003 | Alduby | D26/118 |
| D482,158 S | 11/2003 | Velikov et al. | D26/128 |
| 6,652,124 B2 | 11/2003 | Schubert et al. | 362/285 |
| 6,669,468 B2 | 12/2003 | Pesu | 431/291 |
| 6,742,915 B1 * | 6/2004 | Westerheide | 362/360 |
| D495,822 S * | 9/2004 | Yoneda | D26/124 |
| 6,793,377 B2 * | 9/2004 | Chu | 362/350 |
| 2003/0064337 A1 * | 4/2003 | Pesu | 431/291 |
| 2003/0218883 A1 | 11/2003 | Thevenot | 362/362 |

OTHER PUBLICATIONS

Lumicube, lighting designs by Michael Seal; 'LUMISHADES', www.lumicube.com/pages/lumishades.html; 2002.

Global Lighting; "eda c"; <http://globallighting.net/product.htm?c=3&p=63>; 2004.

select website pages from <http://www.doveworld.org/ebay/Antiques/Lamps/TABLELAMPS/070614woodmetaltabela...> dated Aug. 2, 2007; 4 pages.

select catalog pages entitled "ikarus . . . design katalog" dated 1998; 3 pages.

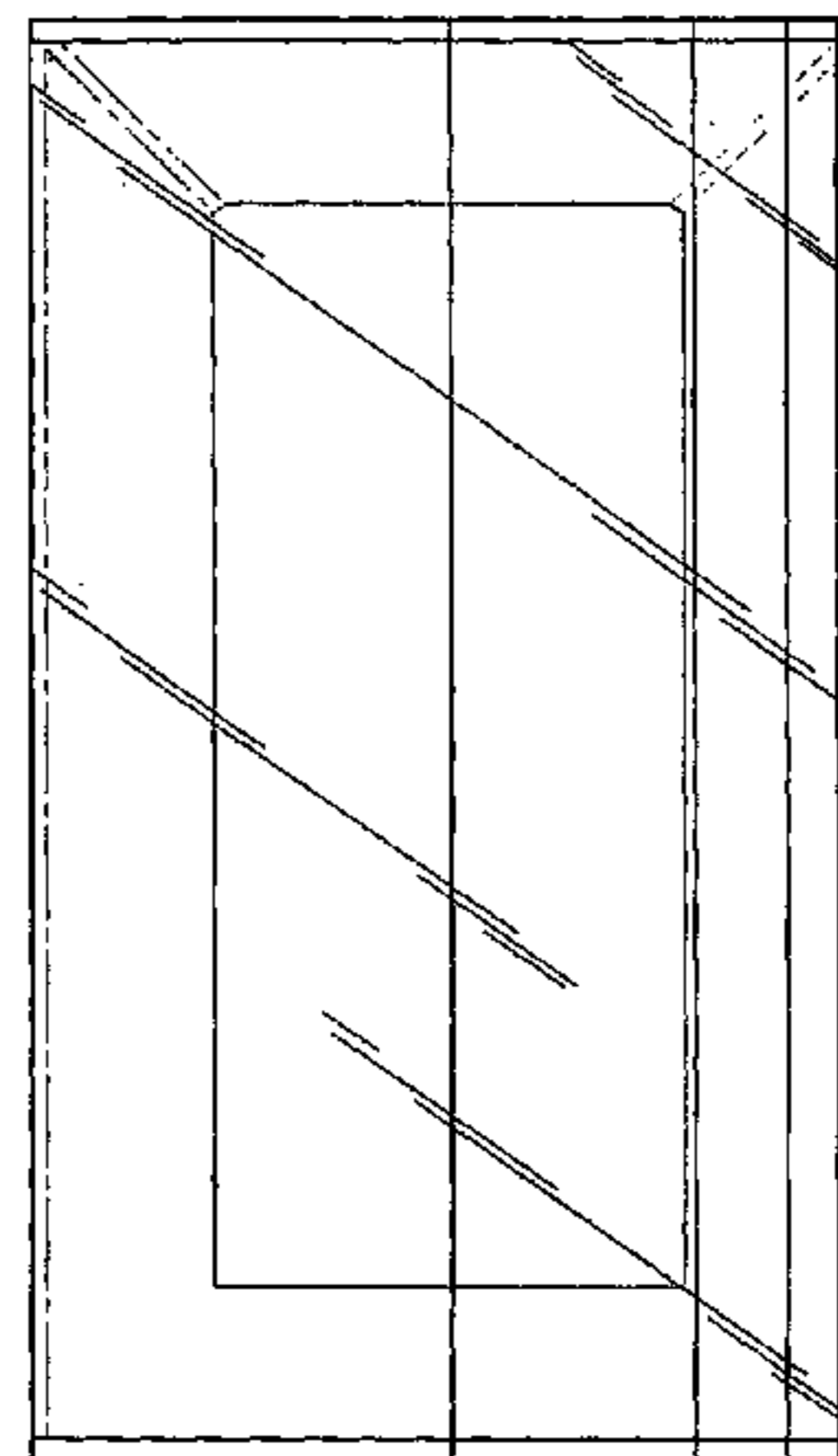
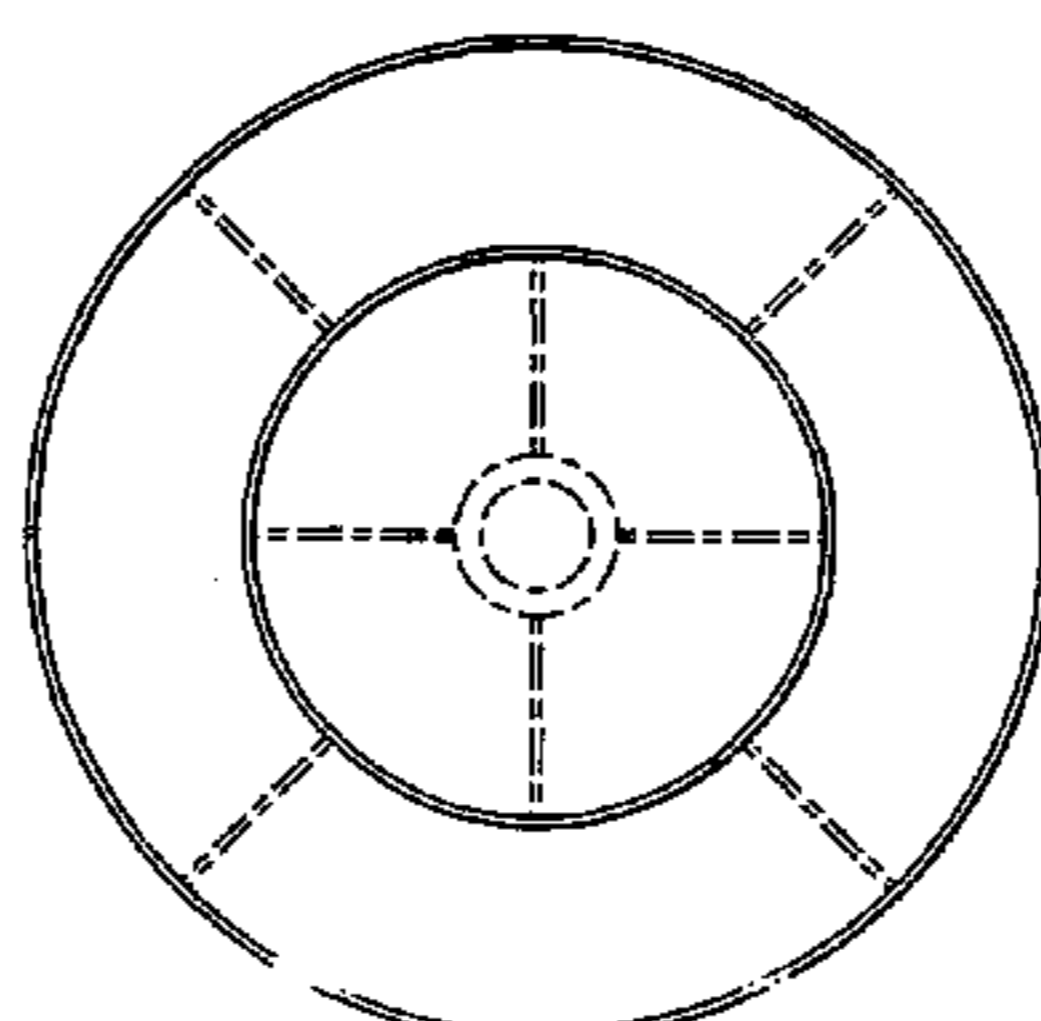
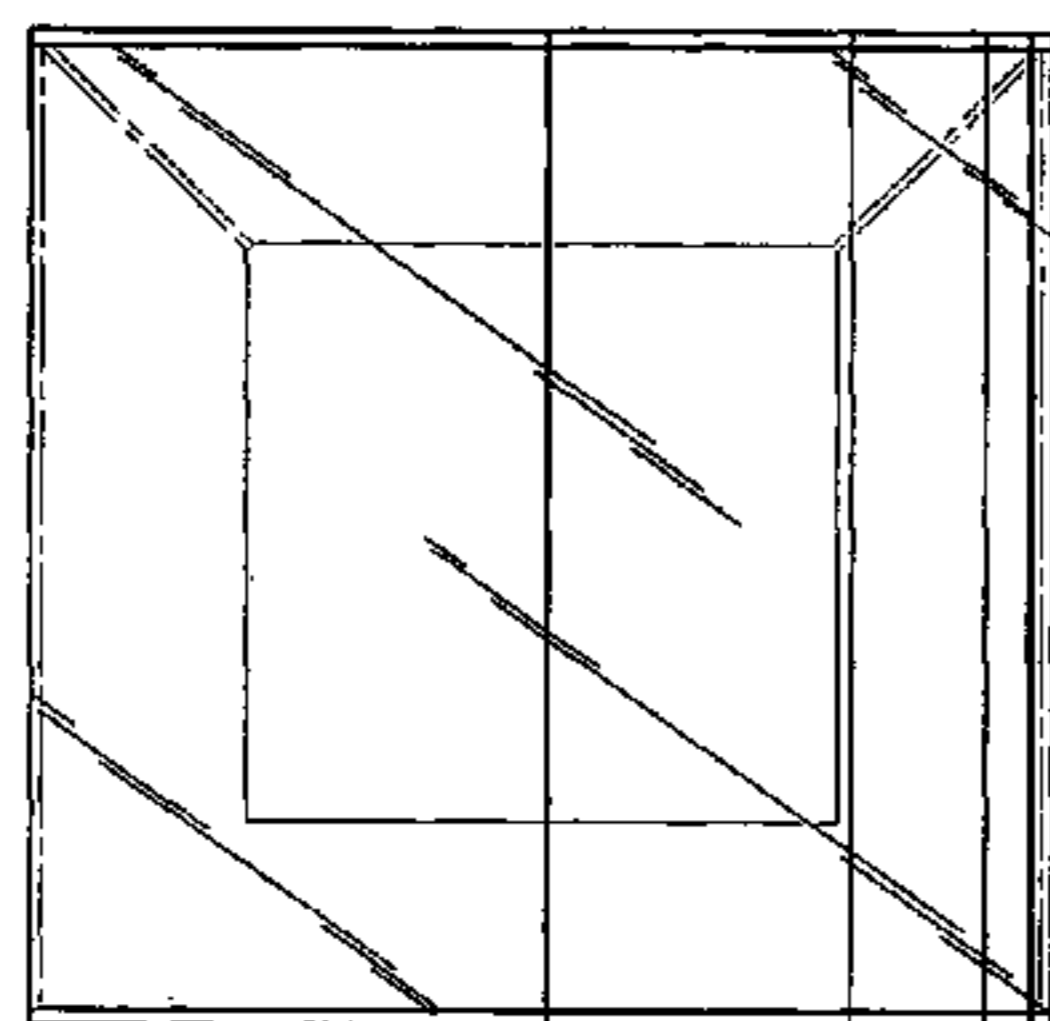

select catalog pages entitled "Il Giornale Dell'Arredamento" dated Apr. 1997; 2 pages.

* cited by examiner

Primary Examiner—Freda S. Nunn

Assistant Examiner—Kevin K. Rudzinski

(74) *Attorney, Agent, or Firm*—McCormick Paulding & Huber LLP

(57) **CLAIM**

The ornamental design for a lampshade, as shown and described.

DESCRIPTION

FIG. 1 is a front view of a lampshade comprising a first embodiment of the new original and ornamental design, the rear, left-hand and right-hand side views being a mirror image thereof.

FIG. 2 is a bottom view of a lampshade comprising the first embodiment of the new, original and ornamental design.

FIG. 3 is a top view of a lampshade comprising the first embodiment of the new, original and ornamental design.

FIG. 4 is a front view of a lampshade comprising a second embodiment of the new original and ornamental design, the rear, left-hand and right-hand side views being a mirror image thereof.

FIG. 5 is a bottom view of a lampshade comprising the second embodiment of the new, original and ornamental design.

FIG. 6 is a top view of a lampshade comprising the second embodiment of the new, original and ornamental design.

FIG. 7 is a front view of a lampshade comprising a third embodiment of the new original and ornamental design, the rear, left-hand and right-hand side views being a mirror image thereof.

FIG. 8 is a bottom view of a lampshade comprising the third embodiment of the new, original and ornamental design.

FIG. 9 is a top view of a lampshade comprising the third embodiment of the new, original and ornamental design.

FIG. 10 is a front view of a lampshade comprising a fourth embodiment of the new original and ornamental design, the rear, left-hand and right-hand side views being a mirror image thereof.

FIG. 11 is a bottom view of a lampshade comprising the fourth embodiment of the new, original and ornamental design.

FIG. 12 is a top view of a lampshade comprising the fourth embodiment of the new, original and ornamental design.

FIG. 13 is a front view of a lampshade comprising a fifth embodiment of the new original and ornamental design, the rear, left-hand and right-hand side views being a mirror image thereof.

FIG. 14 is a bottom view of a lampshade comprising the fifth embodiment of the new, original and ornamental design.

FIG. 15 is a top view of a lampshade comprising the fifth embodiment of the new, original and ornamental design.

FIG. 16 is a front view of a lampshade comprising a sixth embodiment of the new original and ornamental design, the rear, left-hand and right-hand side views being a mirror image thereof.

FIG. 17 is a bottom view of a lampshade comprising the sixth embodiment of the new, original and ornamental design.

FIG. 18 is a top view of a lampshade comprising the sixth embodiment of the new, original and ornamental design.

FIG. 19 is a front view of a lampshade comprising a seventh embodiment of the new original and ornamental design, the rear, left-hand and right-hand side views being a mirror image thereof.

FIG. 20 is a bottom view of a lampshade comprising the seventh embodiment of the new, original and ornamental design.

FIG. 21 is a top view of a lampshade comprising the seventh embodiment of the new, original and ornamental design.

FIG. 22 is a front view of a lampshade comprising an eighth embodiment of the new original and ornamental design, the rear, left-hand and right-hand side views being a mirror image thereof.

FIG. 23 is a bottom view of a lampshade comprising the eighth embodiment of the new, original and ornamental design; and,

FIG. 24 is a top view of a lampshade comprising the eighth embodiment of the new, original and ornamental design.

1 Claim, 8 Drawing Sheets

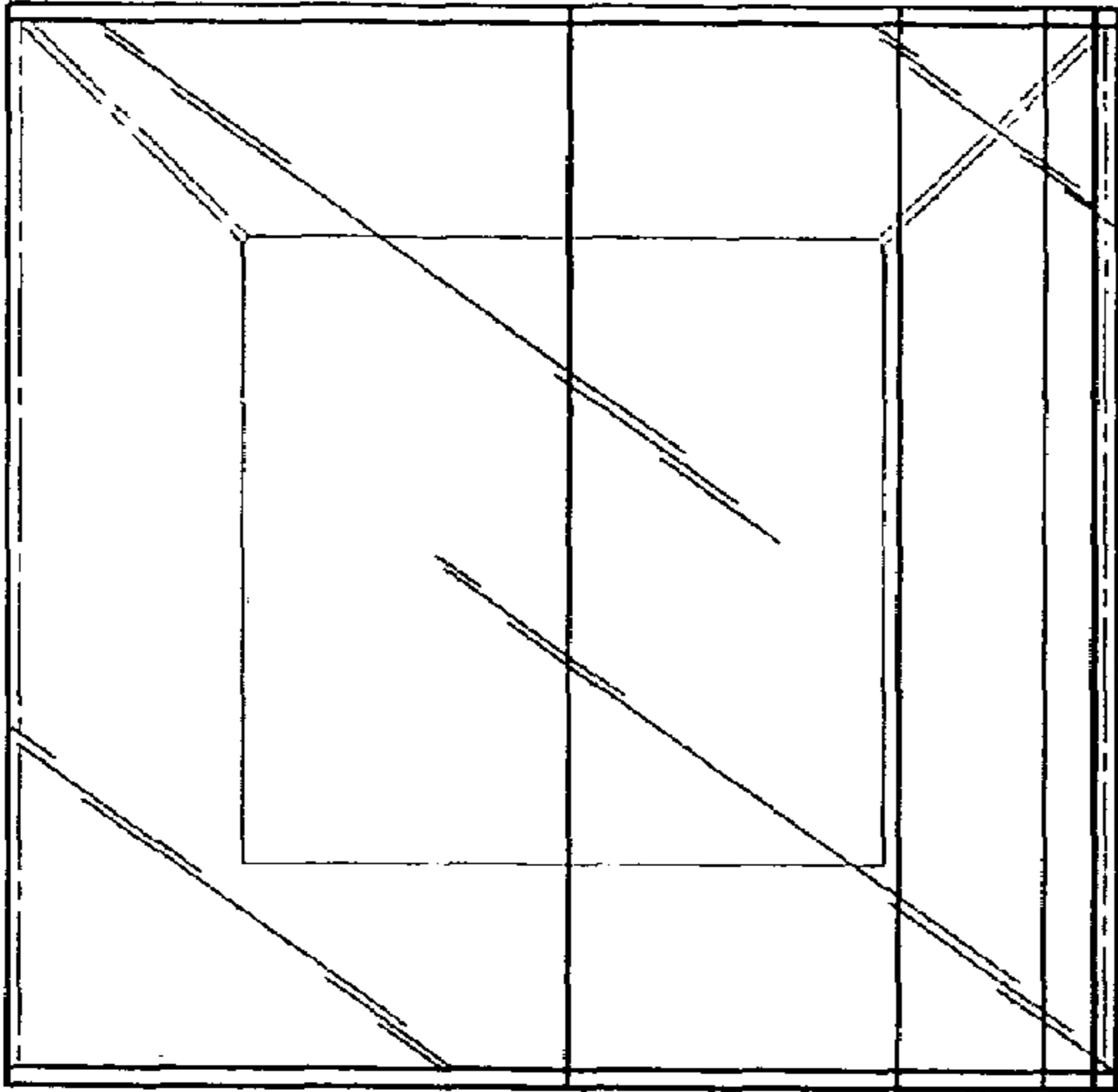

FIG. 1

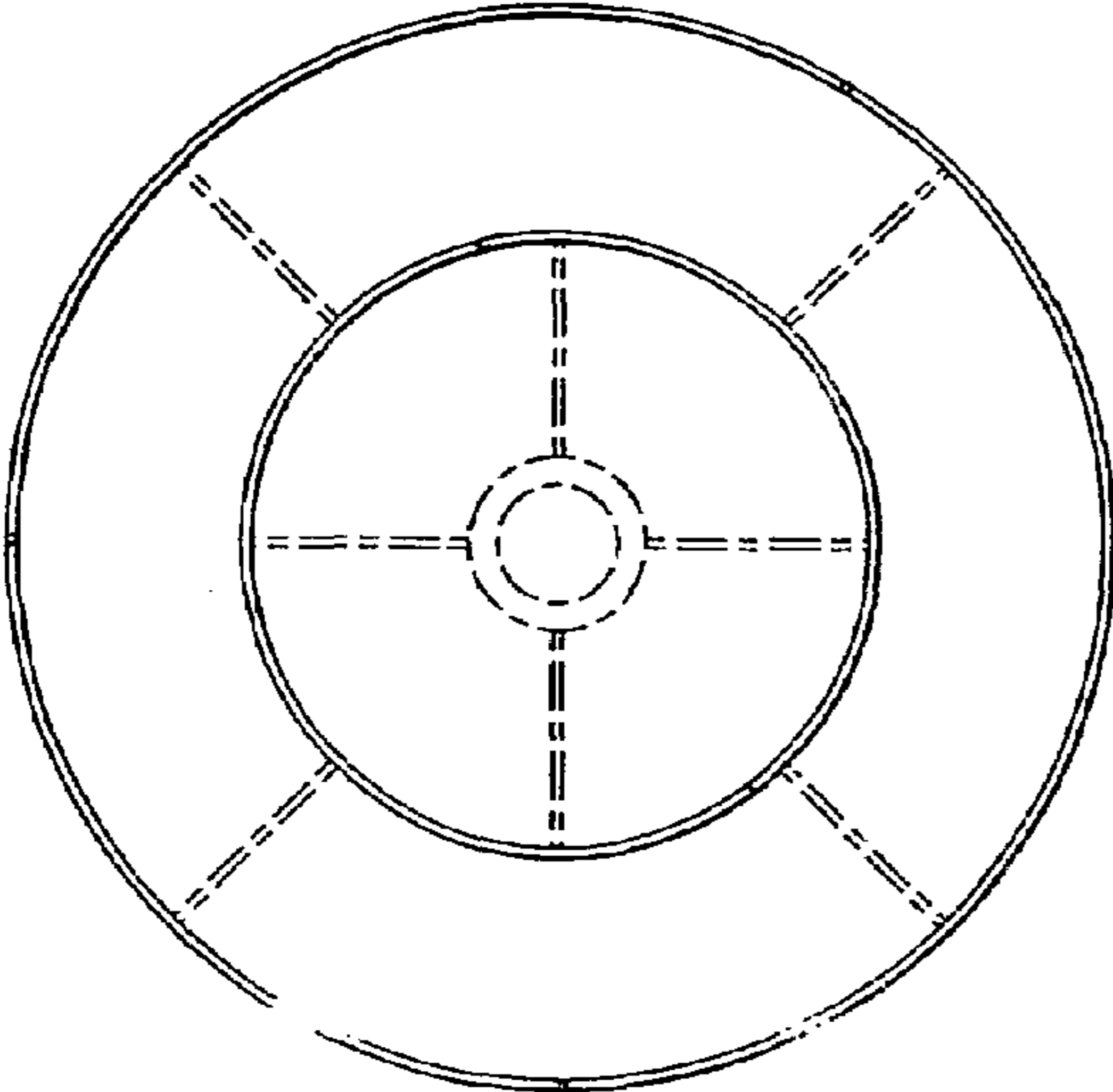

FIG. 2

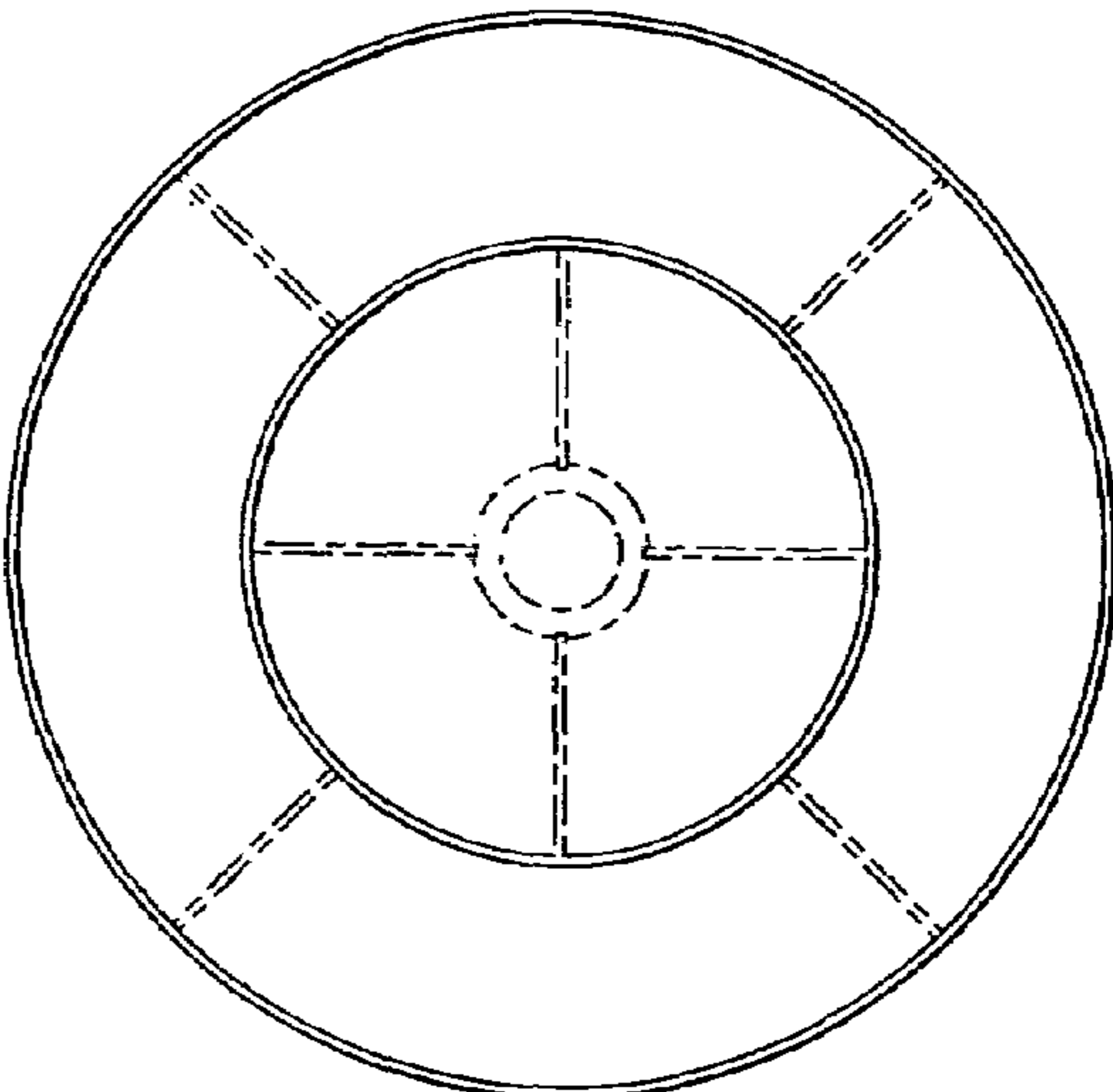

FIG. 3

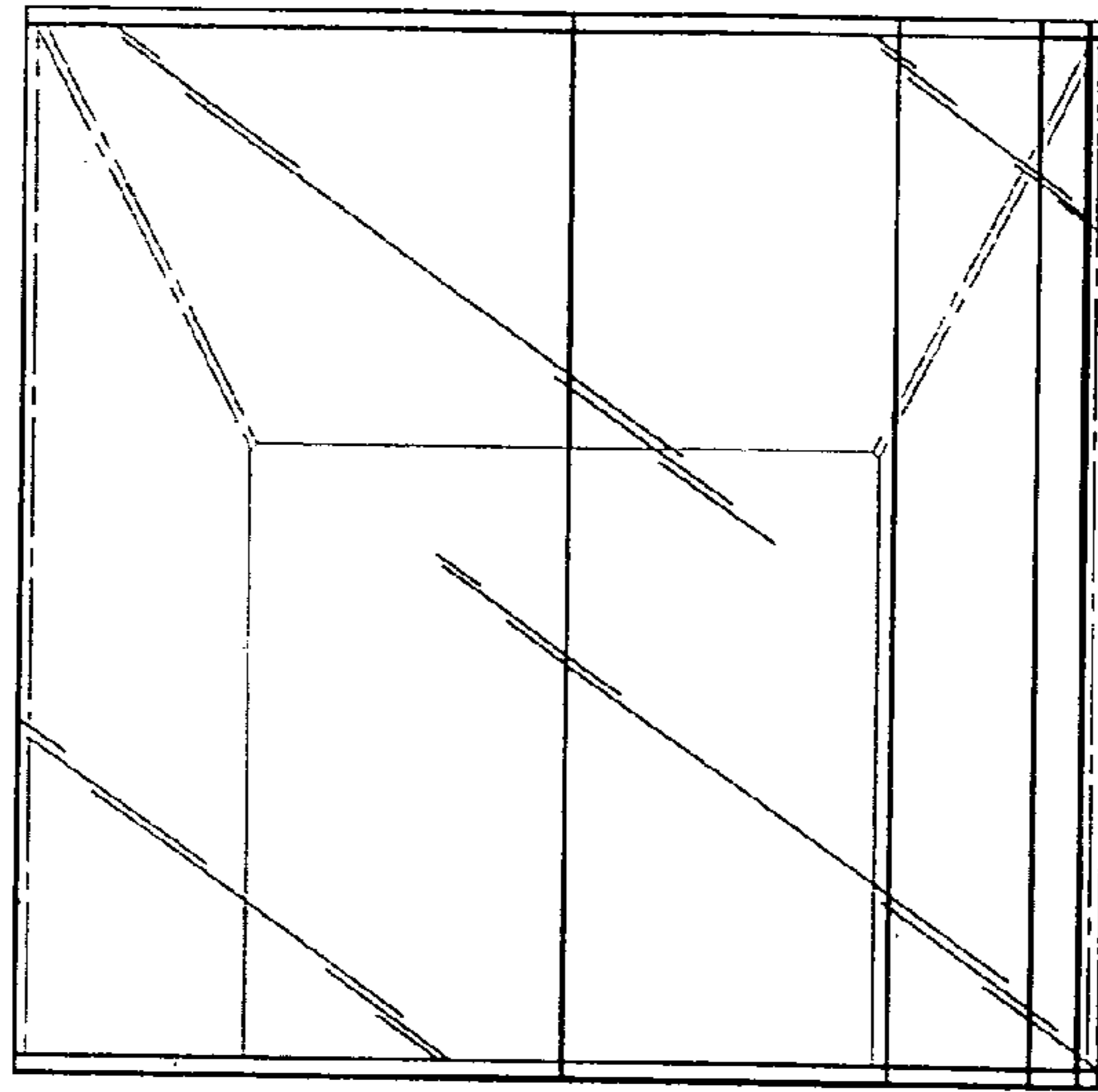

FIG. 4

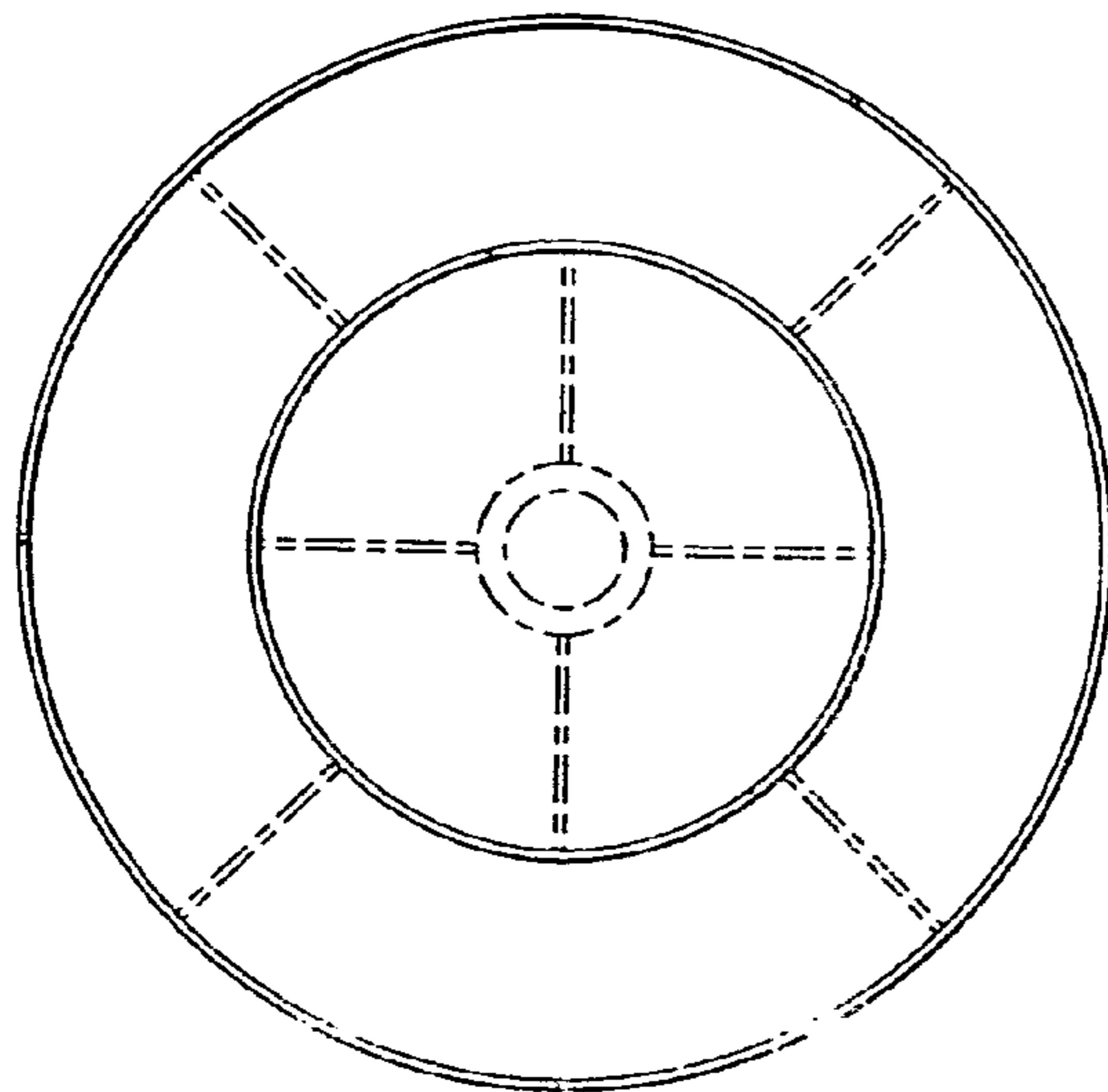

FIG. 5

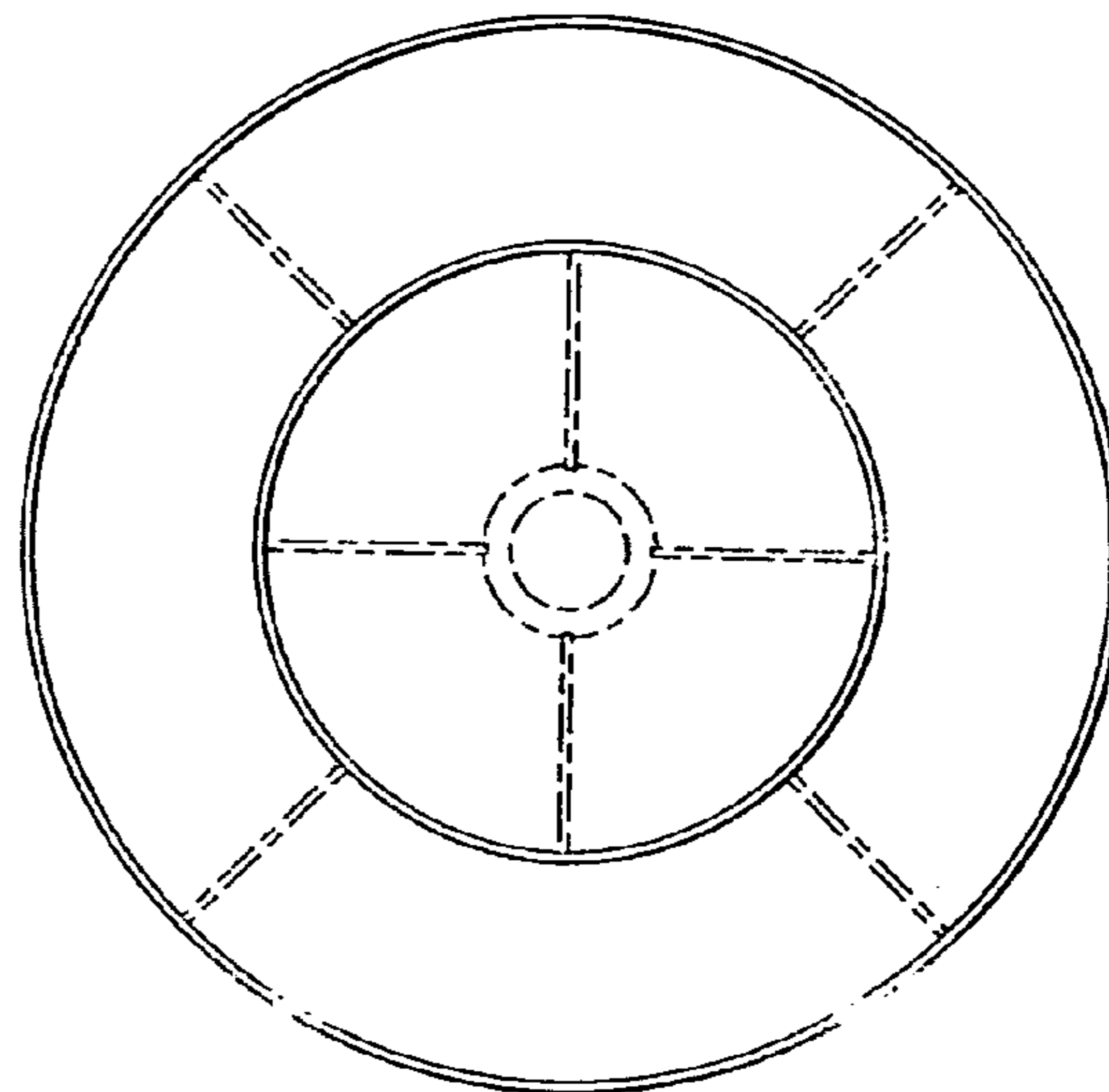

FIG. 6

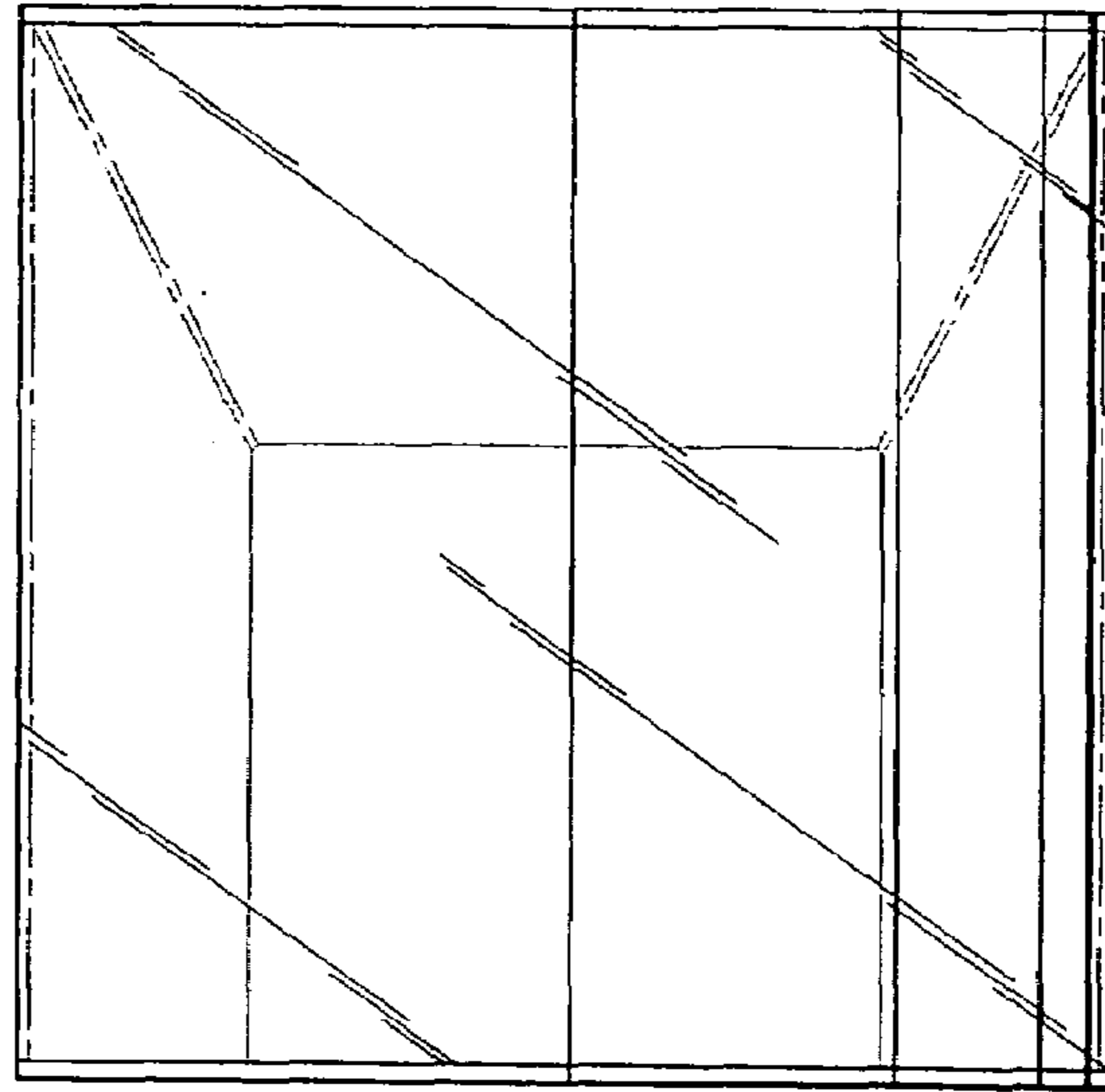

FIG. 7

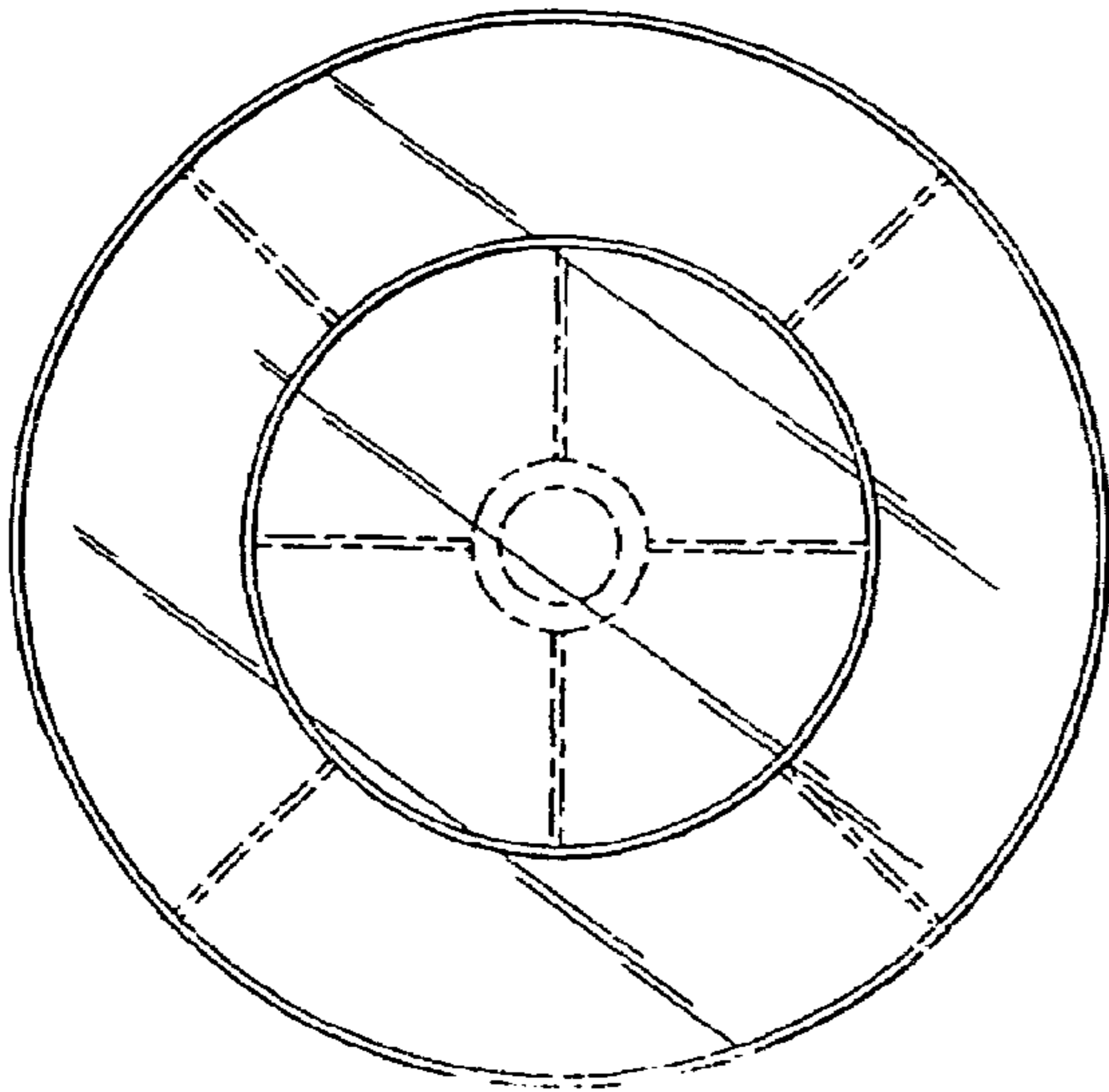

FIG. 8

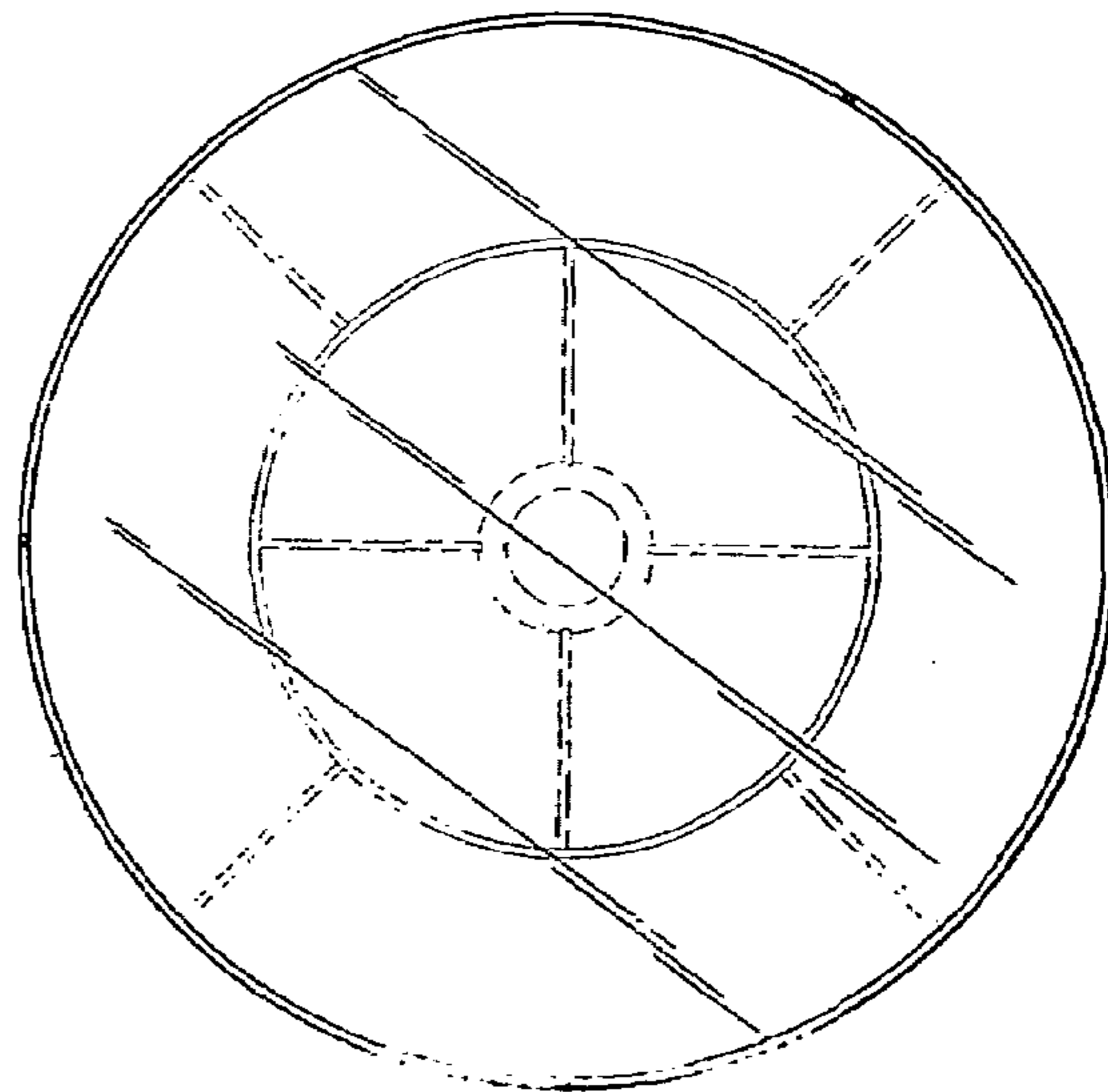

FIG. 9

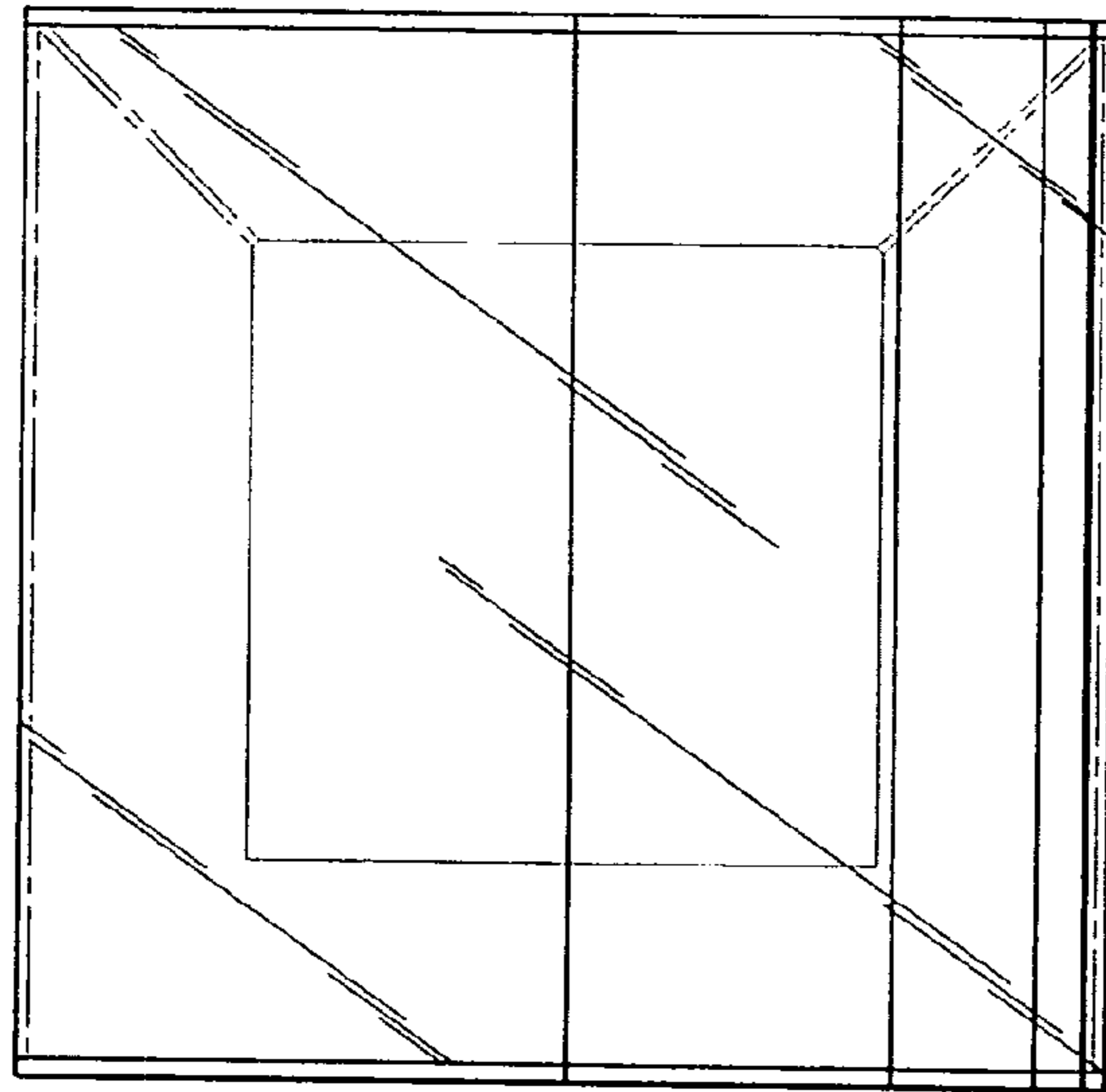

FIG. 10

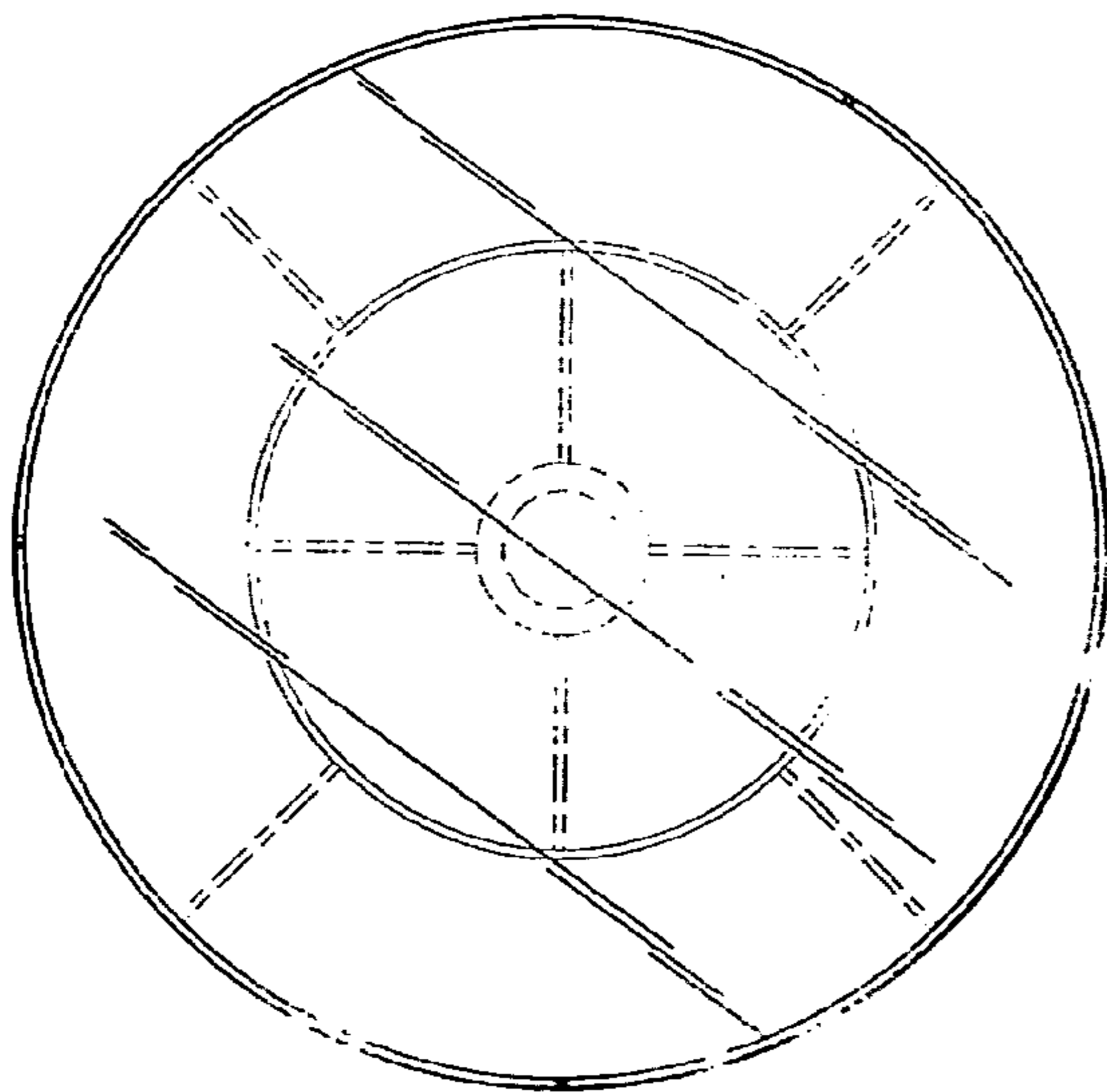

FIG. 11

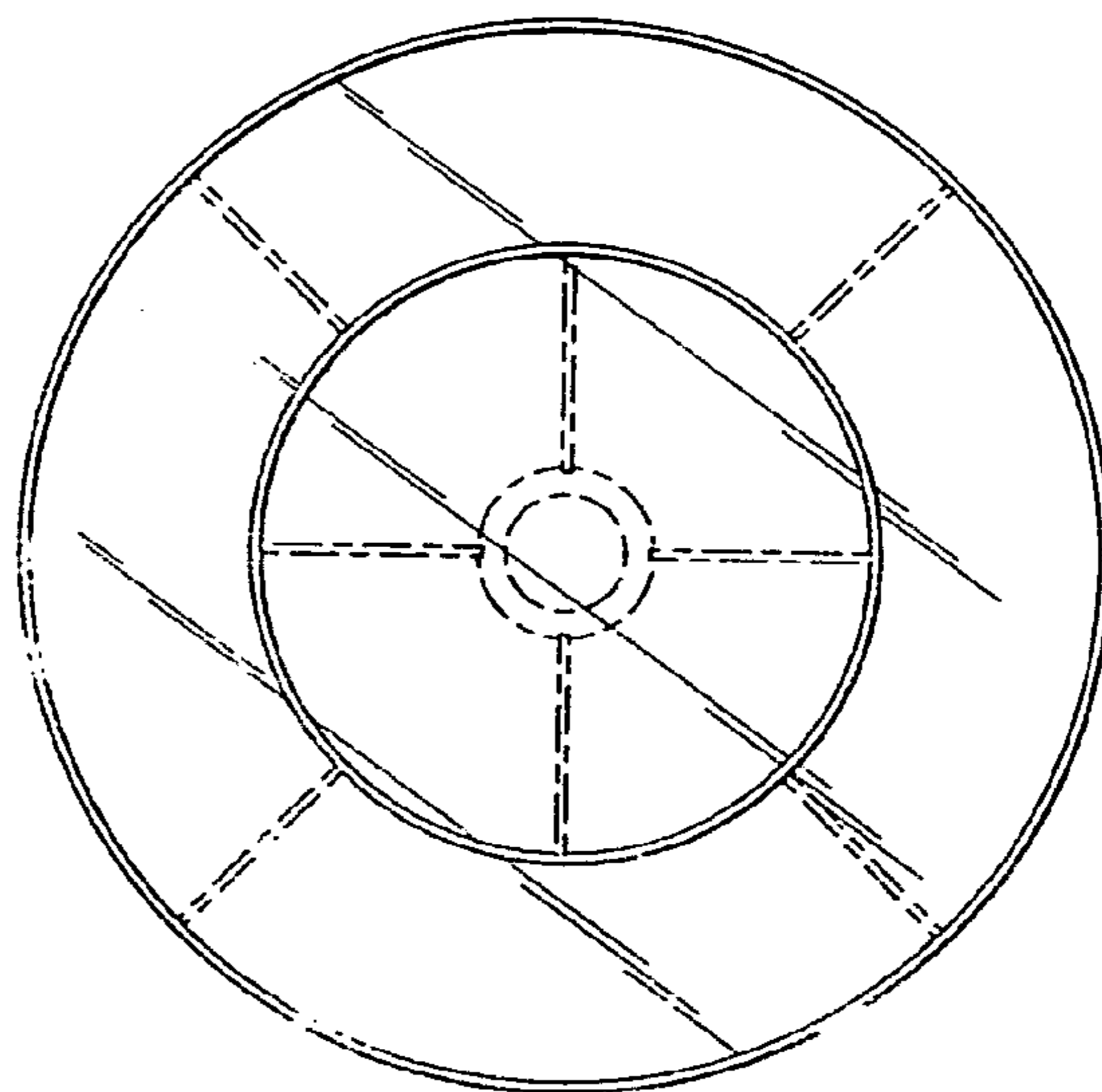

FIG. 12

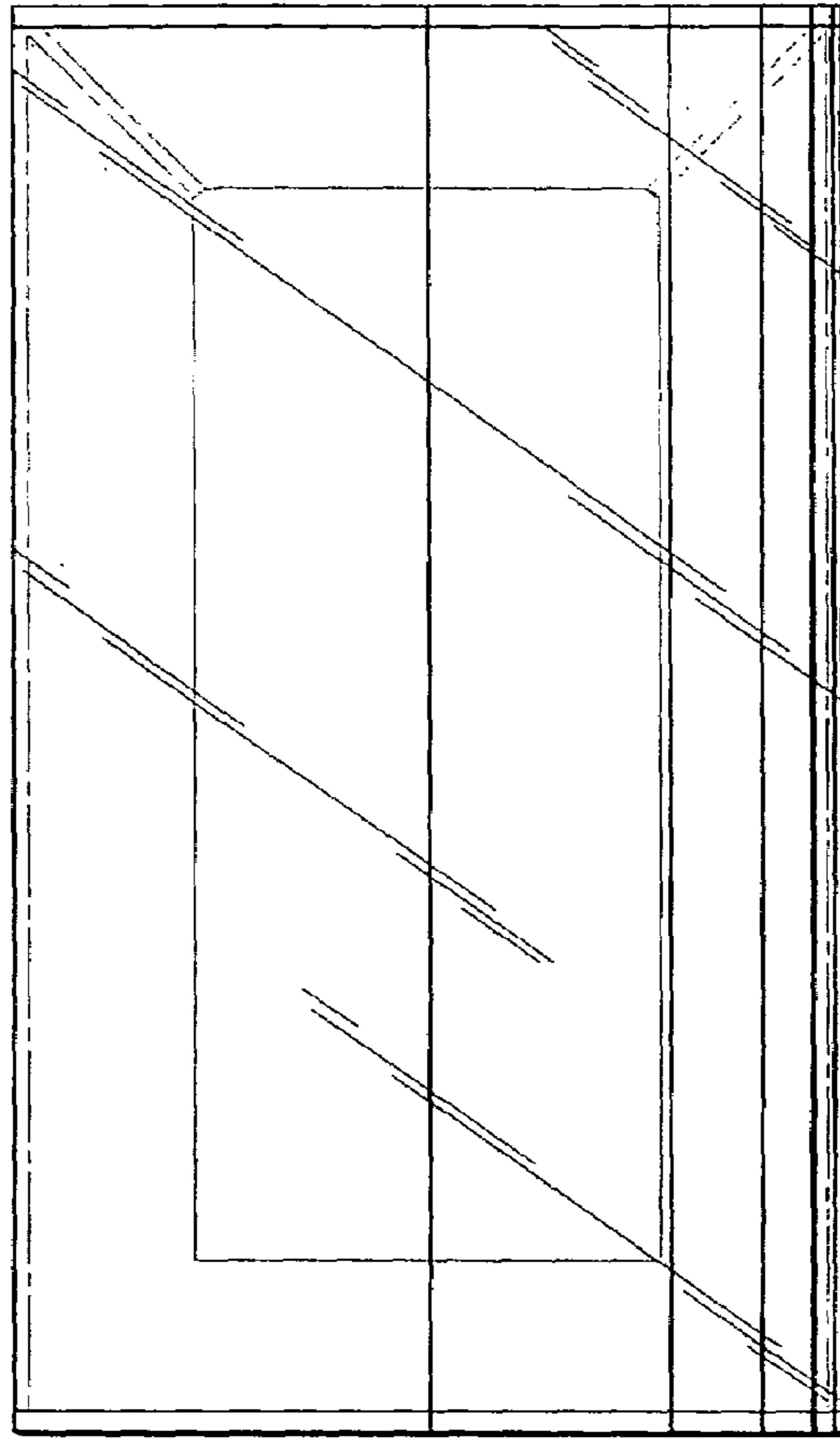

FIG. 13

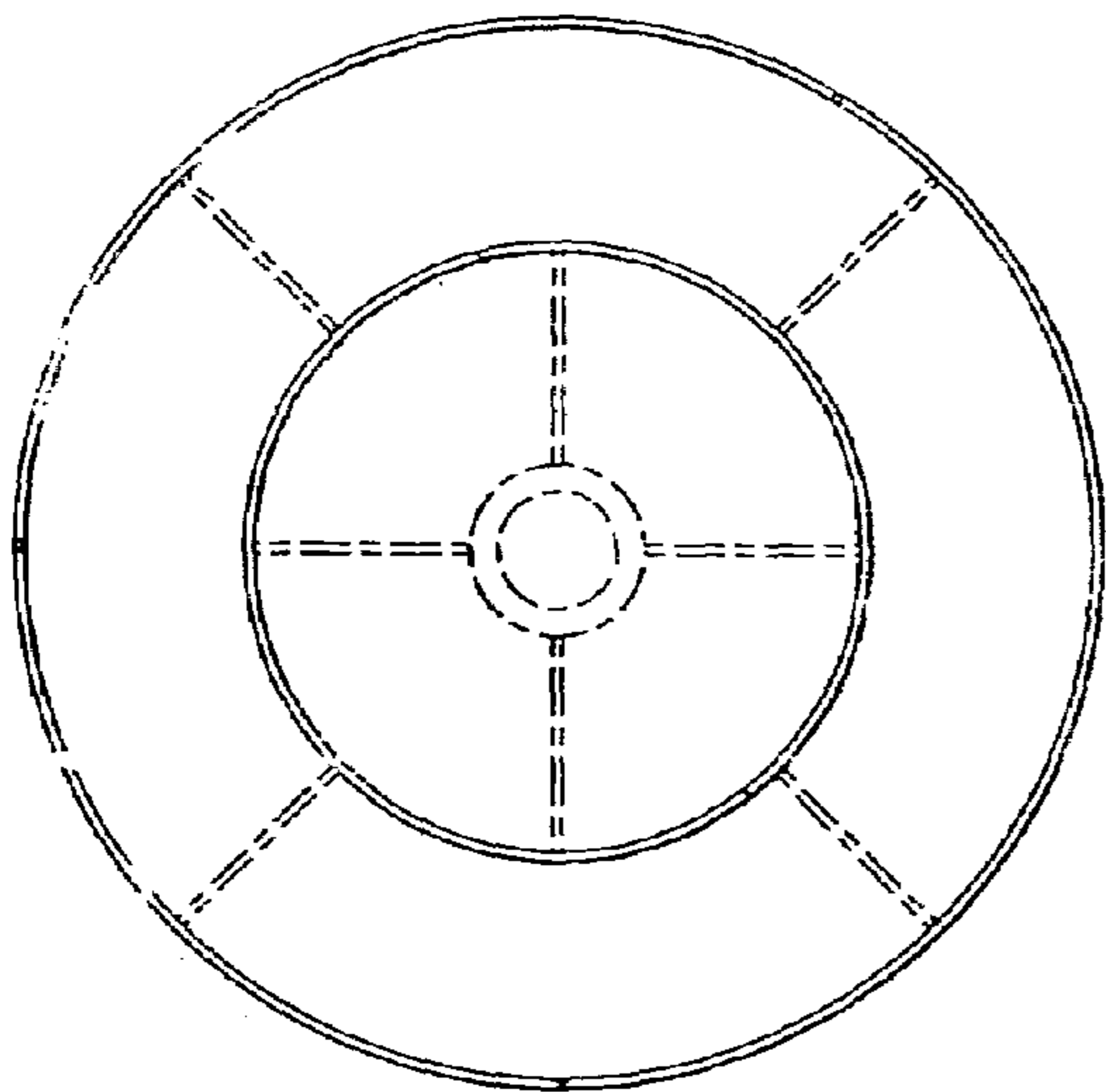

FIG. 14

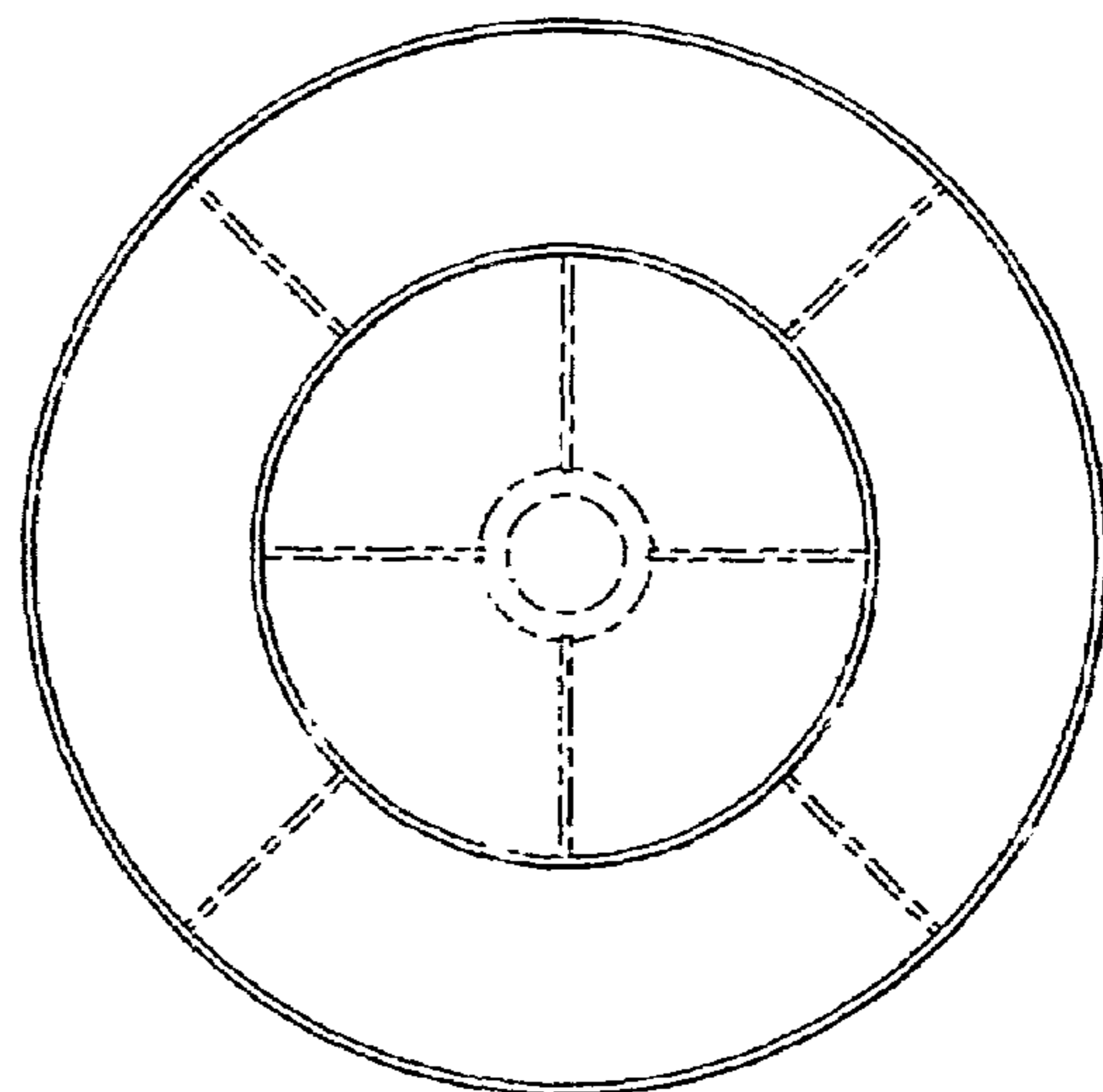

FIG. 15

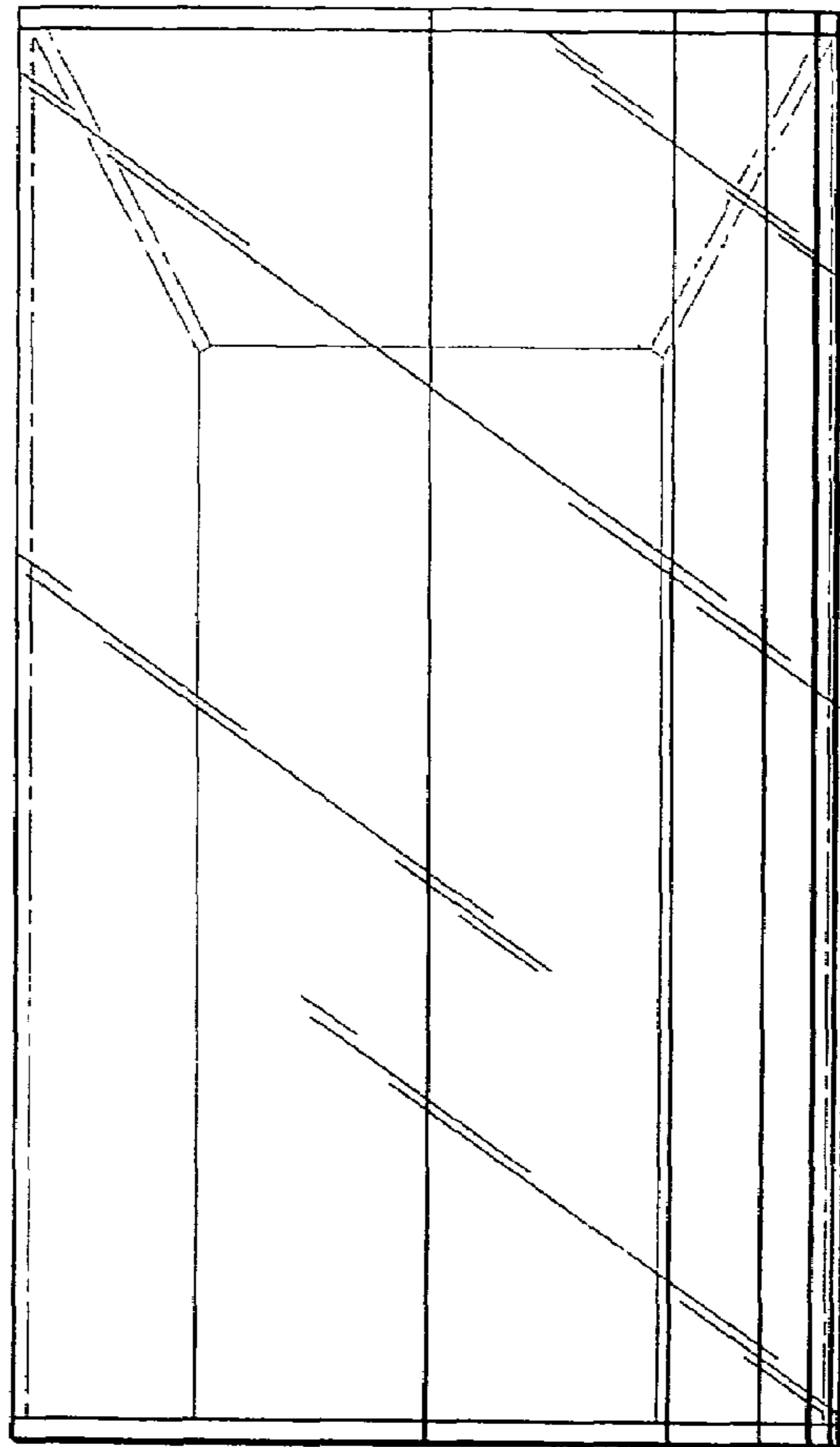

FIG. 16

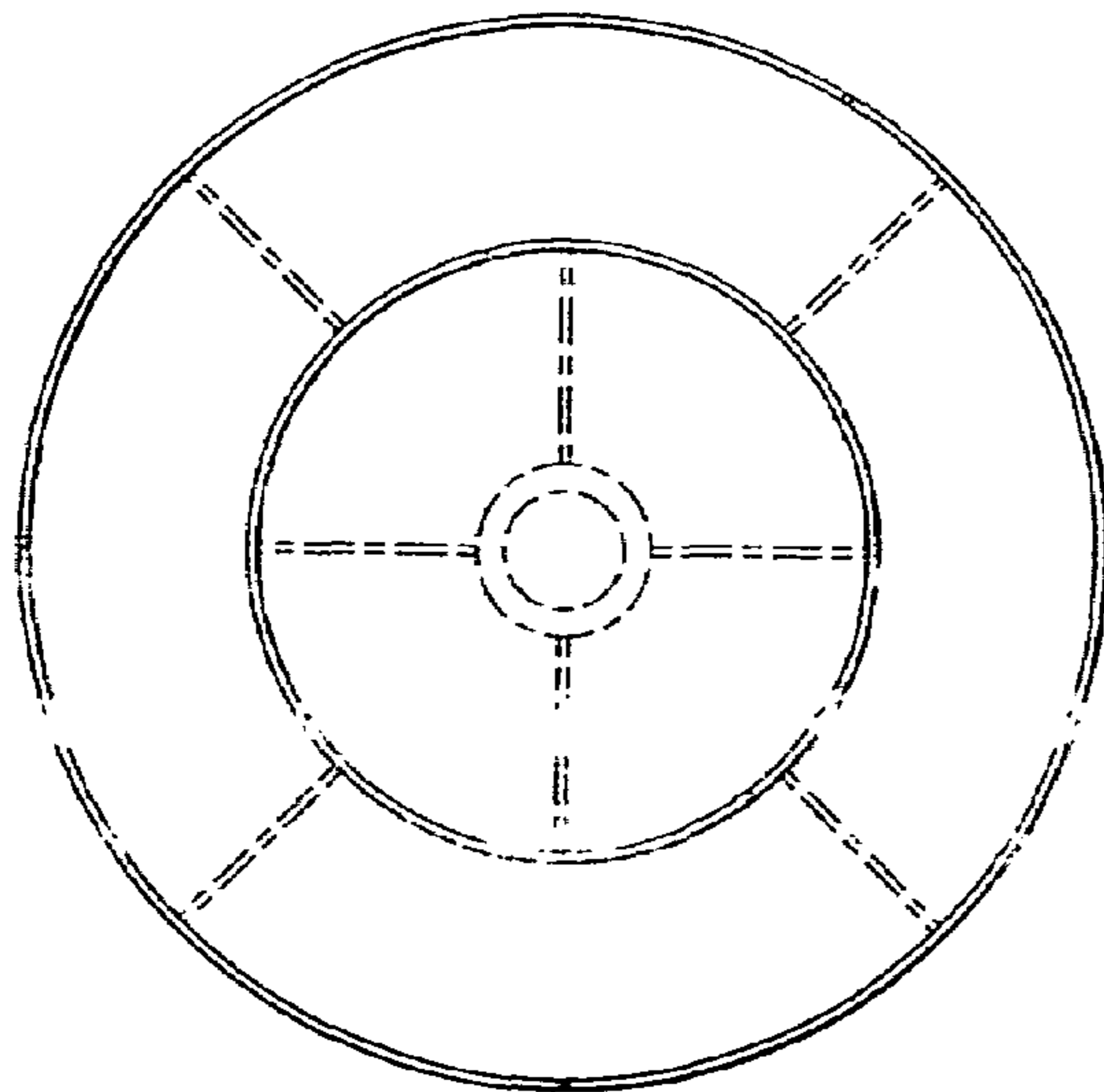

FIG. 17

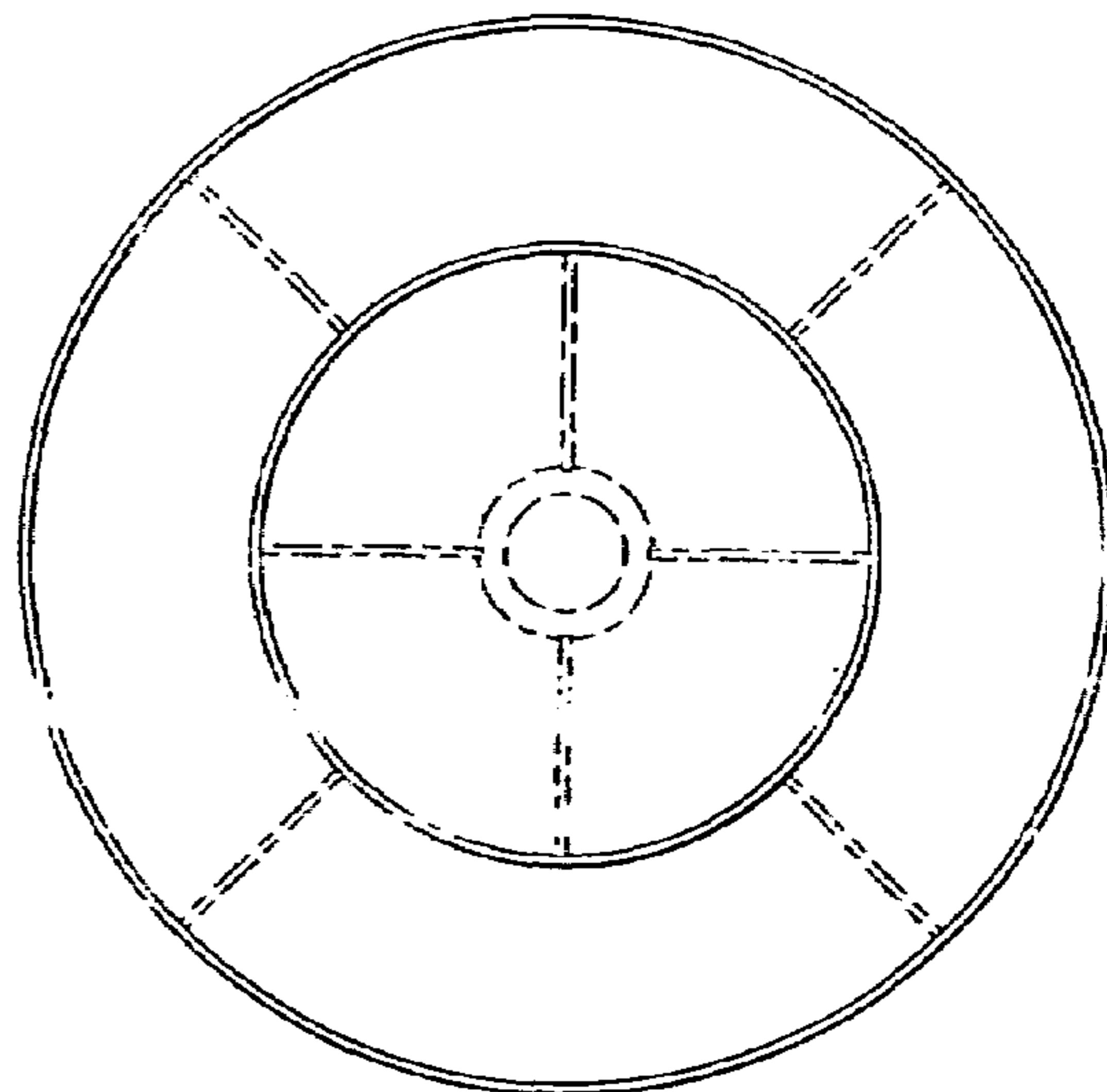

FIG. 18

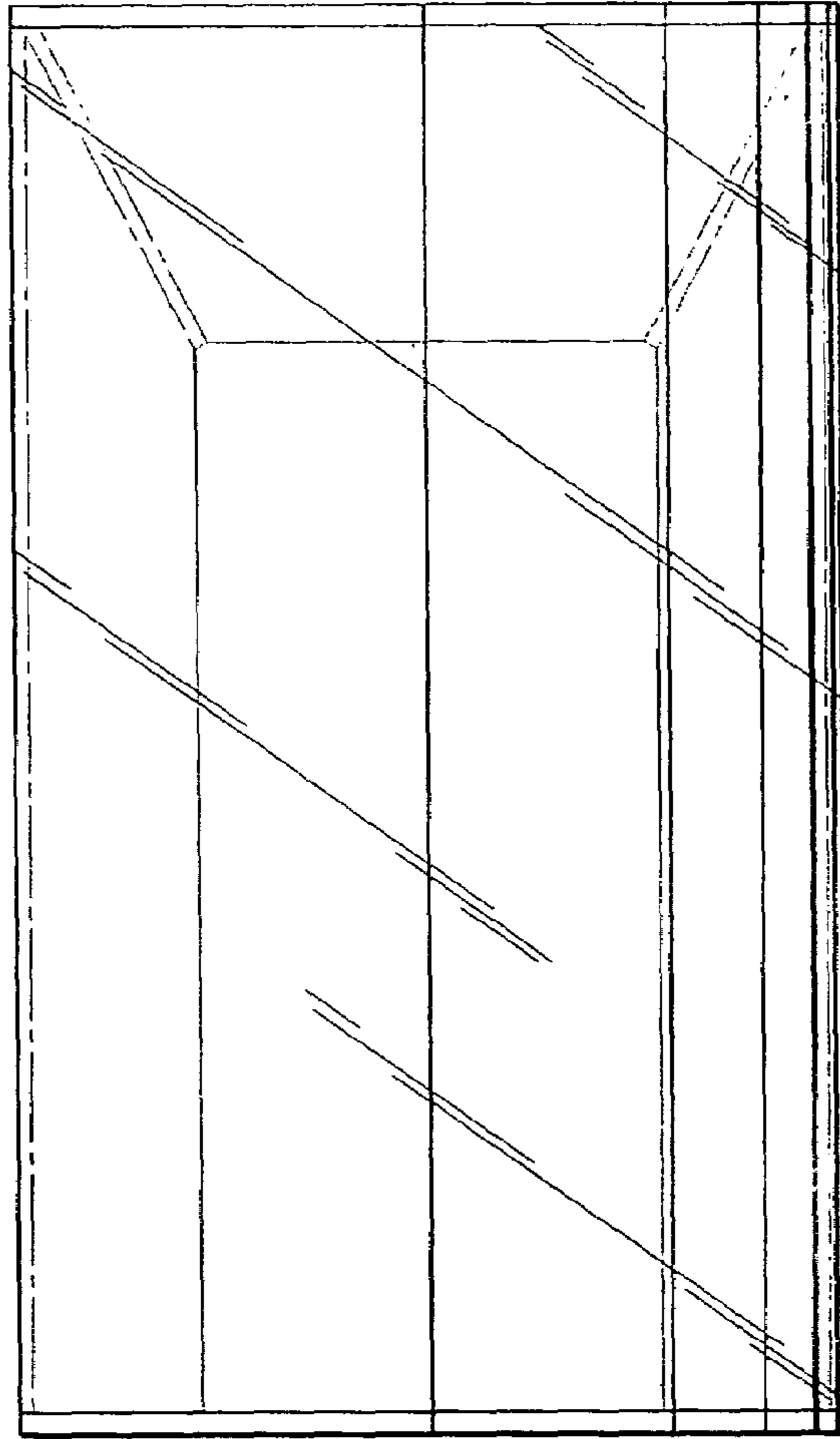

FIG. 19

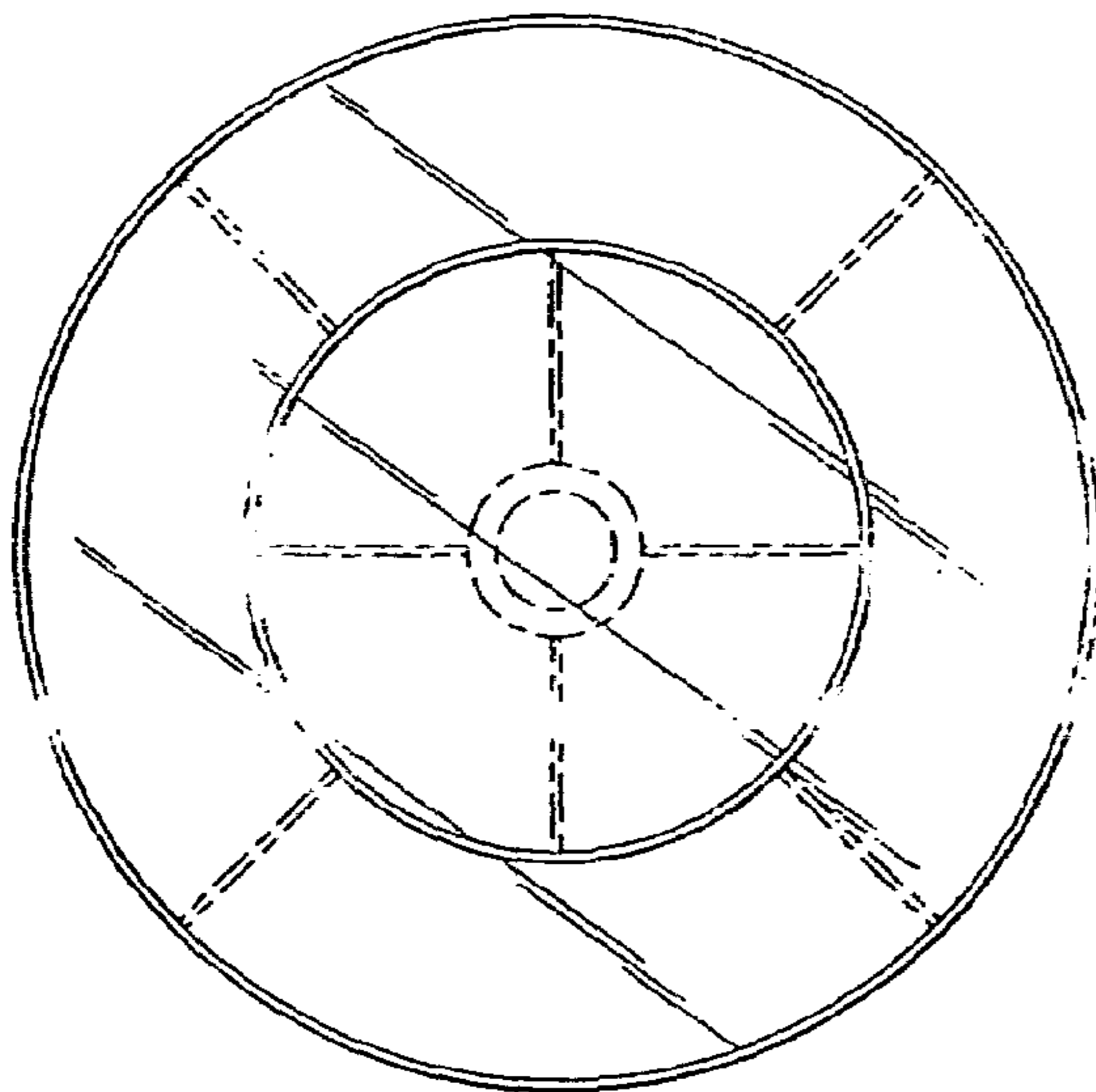

FIG. 20

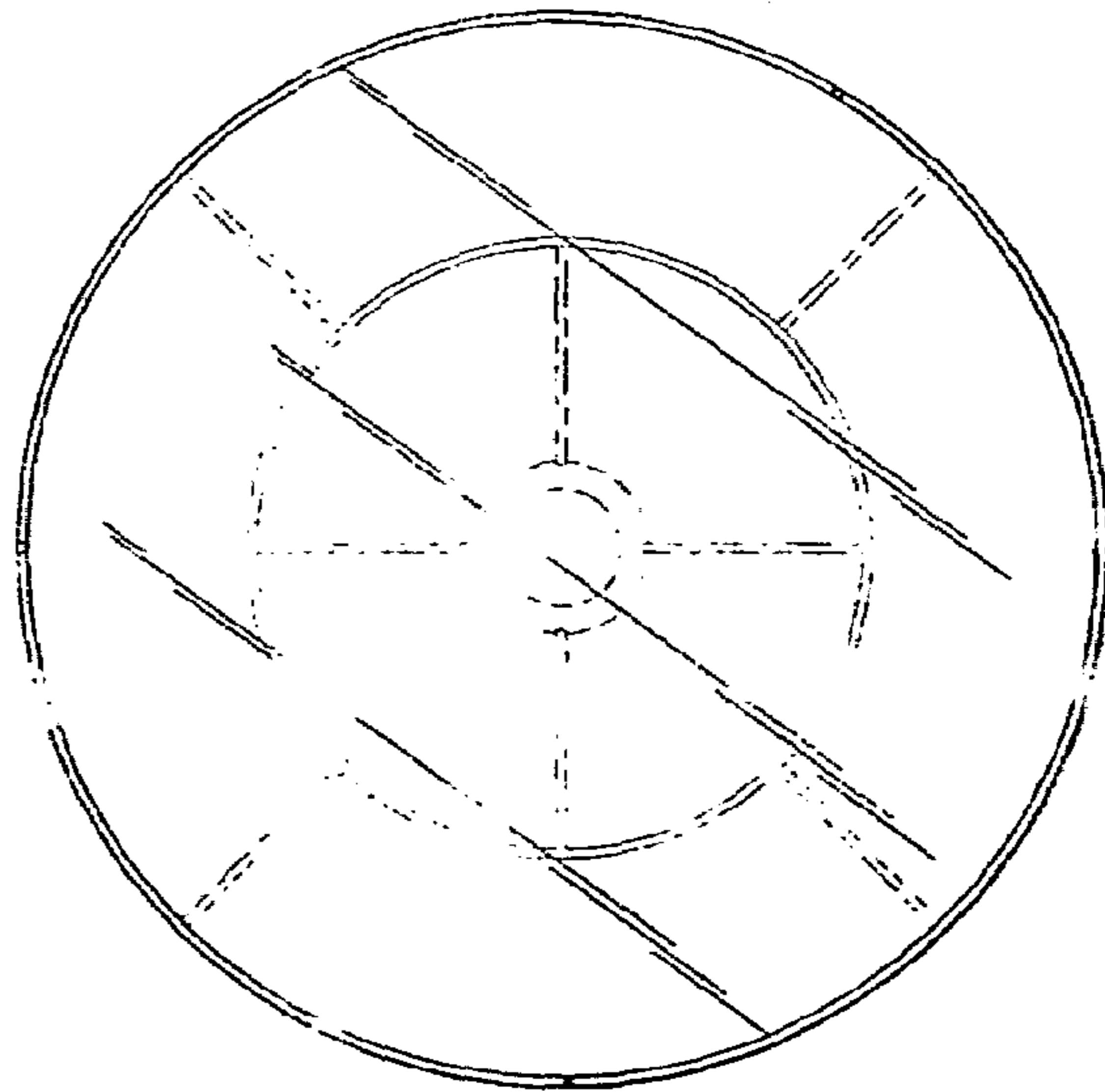

FIG. 21

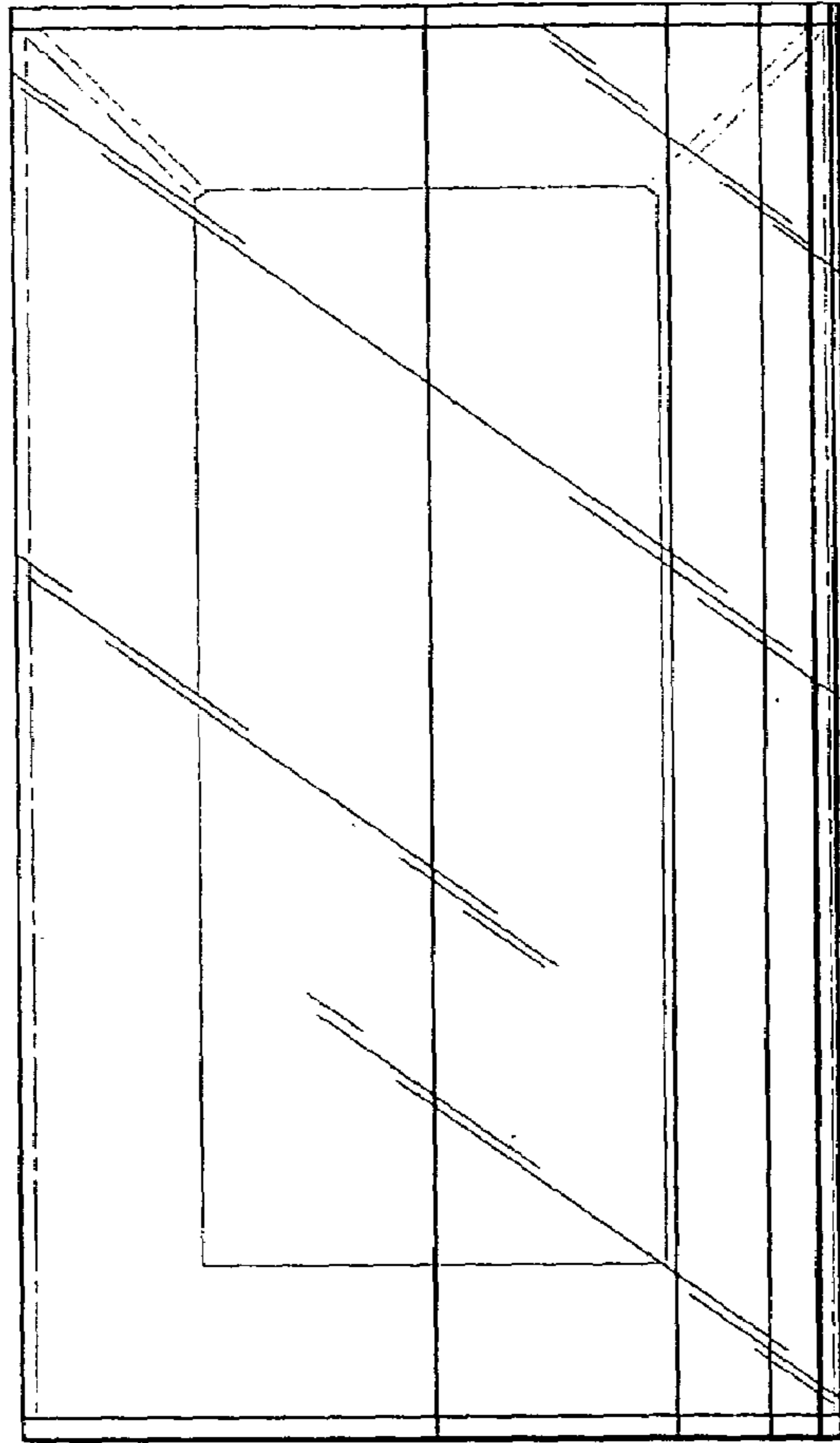

FIG. 22

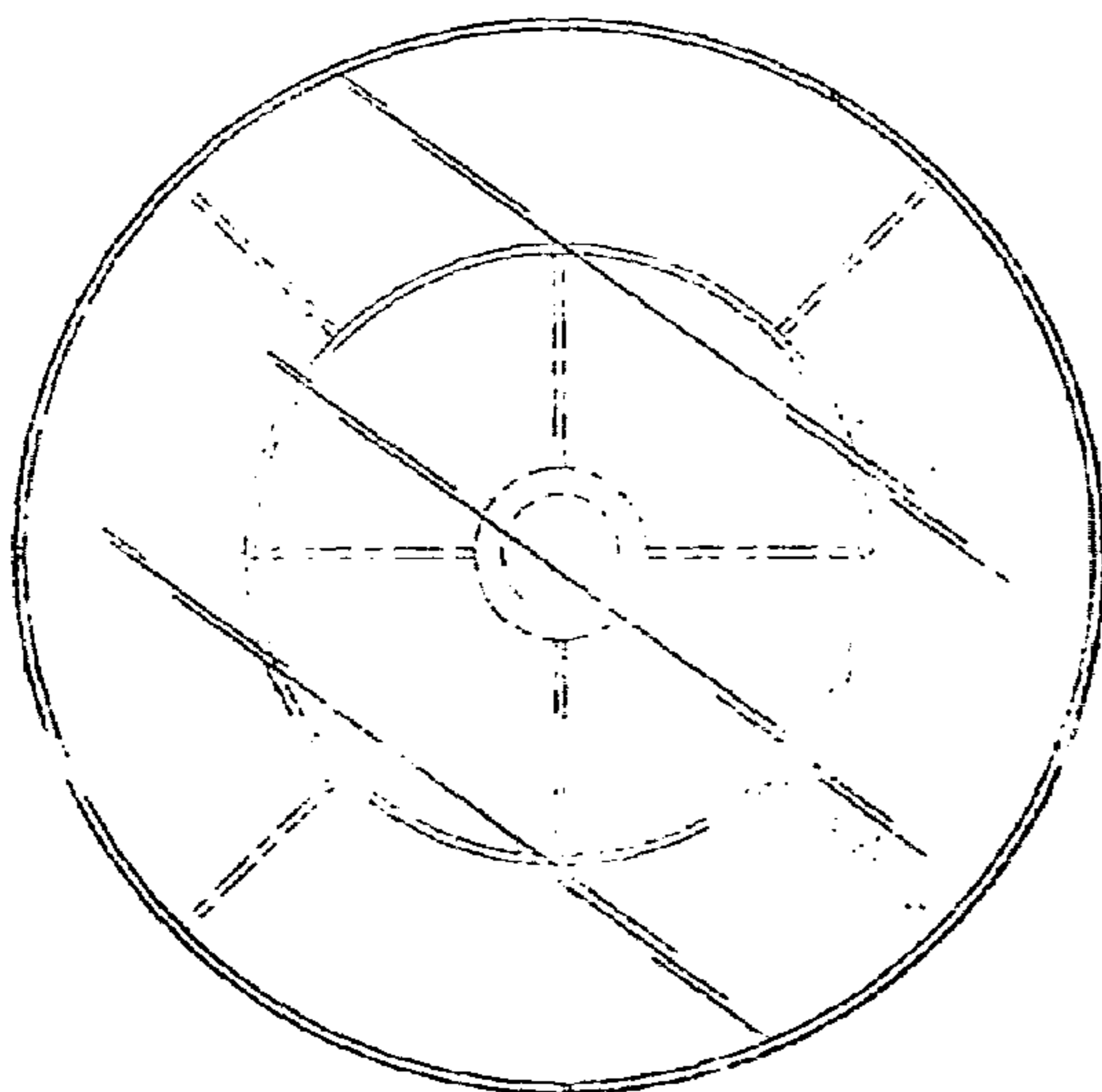

FIG. 23

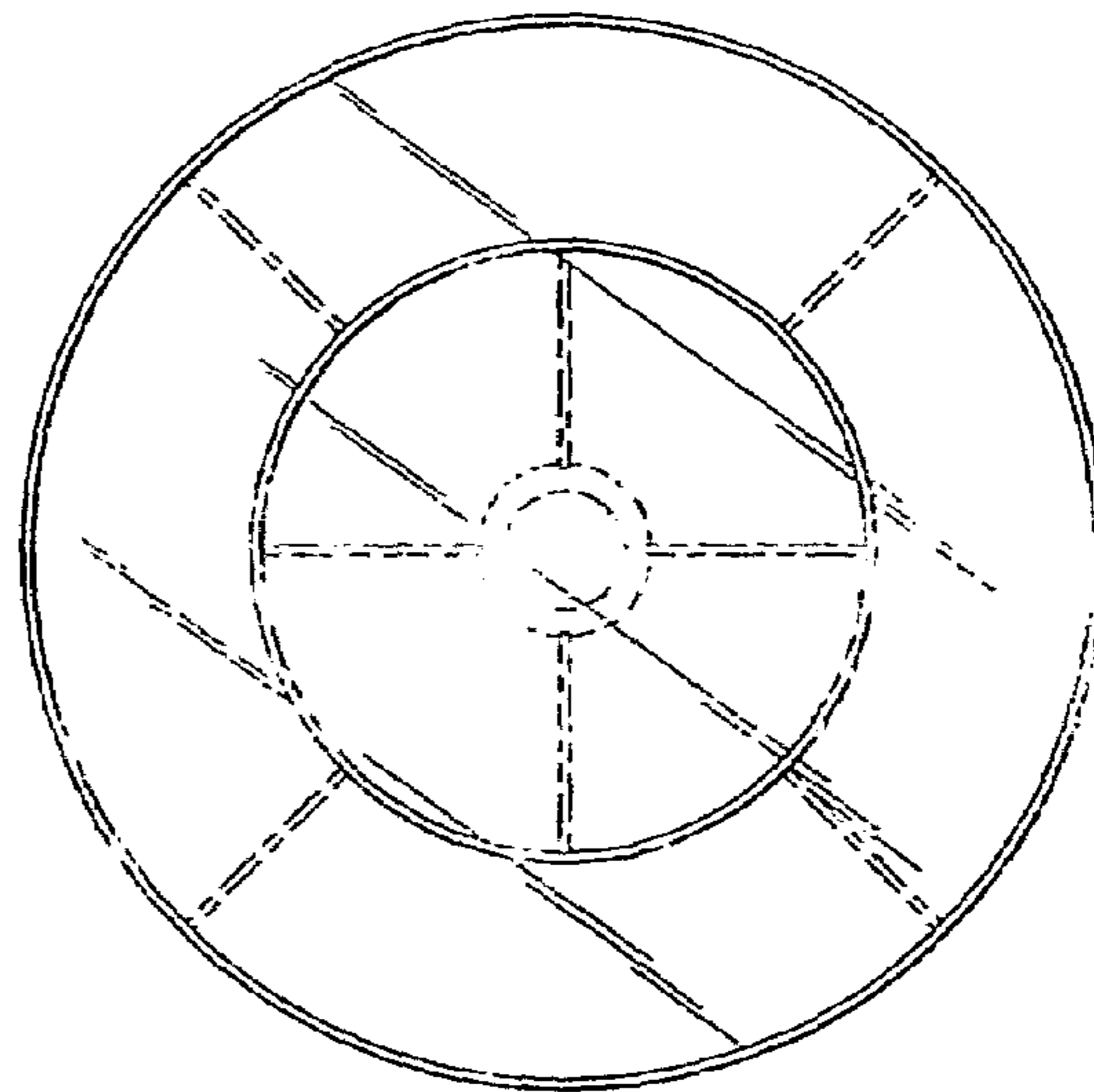

FIG. 24