



US00D557423S

(12) **United States Design Patent** (10) **Patent No.:** **US D557,423 S**
Chen (45) **Date of Patent:** **** Dec. 11, 2007**

(54) **HEART RATE SENSOR DEVICE EMBEDDED CONTACT**

D524,943 S * 7/2006 Faller et al. D24/167
D536,673 S * 2/2007 Silber D13/182
7,214,107 B2 * 5/2007 Powell et al. 439/729
7,215,989 B1 * 5/2007 Burks 600/393

(76) Inventor: **Yu-Yu Chen**, 65-08, 182 St., Fresh Meadows, NY (US) 11365

* cited by examiner

(**) Term: **14 Years**

Primary Examiner—Robert A. Delehanty

Assistant Examiner—Mark Cavanna

(21) Appl. No.: **29/245,280**

(74) *Attorney, Agent, or Firm*—Rosenberg, Klein & Lee

(22) Filed: **Dec. 22, 2005**

(57) **CLAIM**

(51) **LOC (8) Cl.** **24-01**

The ornamental design for a heart rate sensor device embedded contact, as shown and described.

(52) **U.S. Cl.** **D24/187**

(58) **Field of Classification Search** D24/167,
D24/187, 182; 439/729; 600/382–384,
600/391–393, 372; 607/148–149, 152
See application file for complete search history.

DESCRIPTION

FIG. 1 is a perspective view from the top of a heart rate sensor device embedded contact showing my new design; FIG. 2 is a front elevational view thereof; FIG. 3 is a rear elevational view thereof; FIG. 4 is a left side elevational view thereof; FIG. 5 is a right side elevational view thereof; FIG. 6 is a top plan view thereof; FIG. 7 is a bottom plan view; and, FIG. 8 is a perspective view from the bottom thereof.

(56) **References Cited**

U.S. PATENT DOCUMENTS

D409,752 S * 5/1999 Bishay et al. D24/187
D429,337 S * 8/2000 Sanfilippo D24/187
D456,907 S * 5/2002 Sanfilippo D24/187
D468,433 S * 1/2003 Wagner et al. D24/187
D471,281 S * 3/2003 Baura et al. D24/187
D475,138 S * 5/2003 Baura et al. D24/187
D495,055 S * 8/2004 Silber D24/187
D498,848 S * 11/2004 Vaisnys et al. D24/187

1 Claim, 5 Drawing Sheets

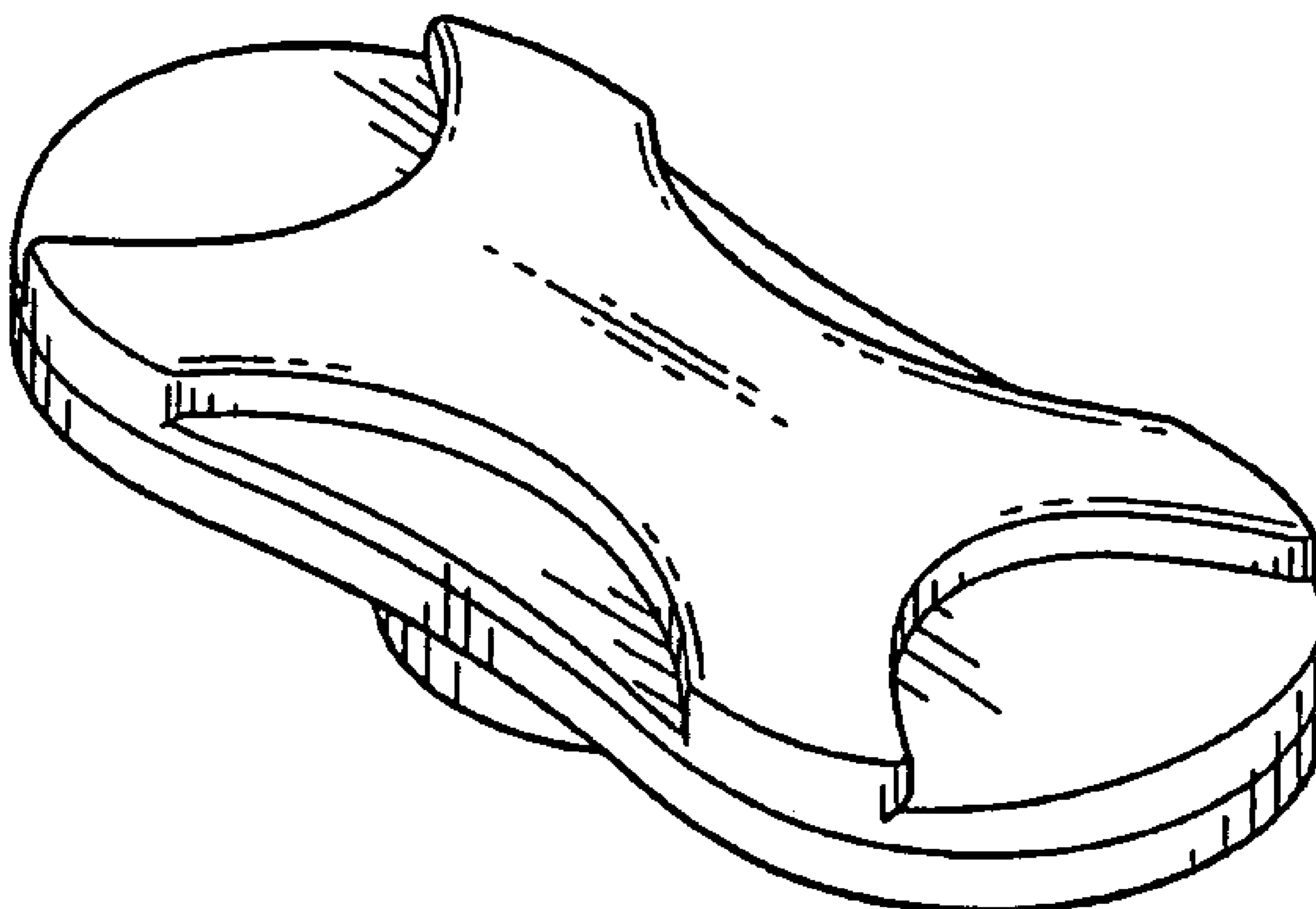

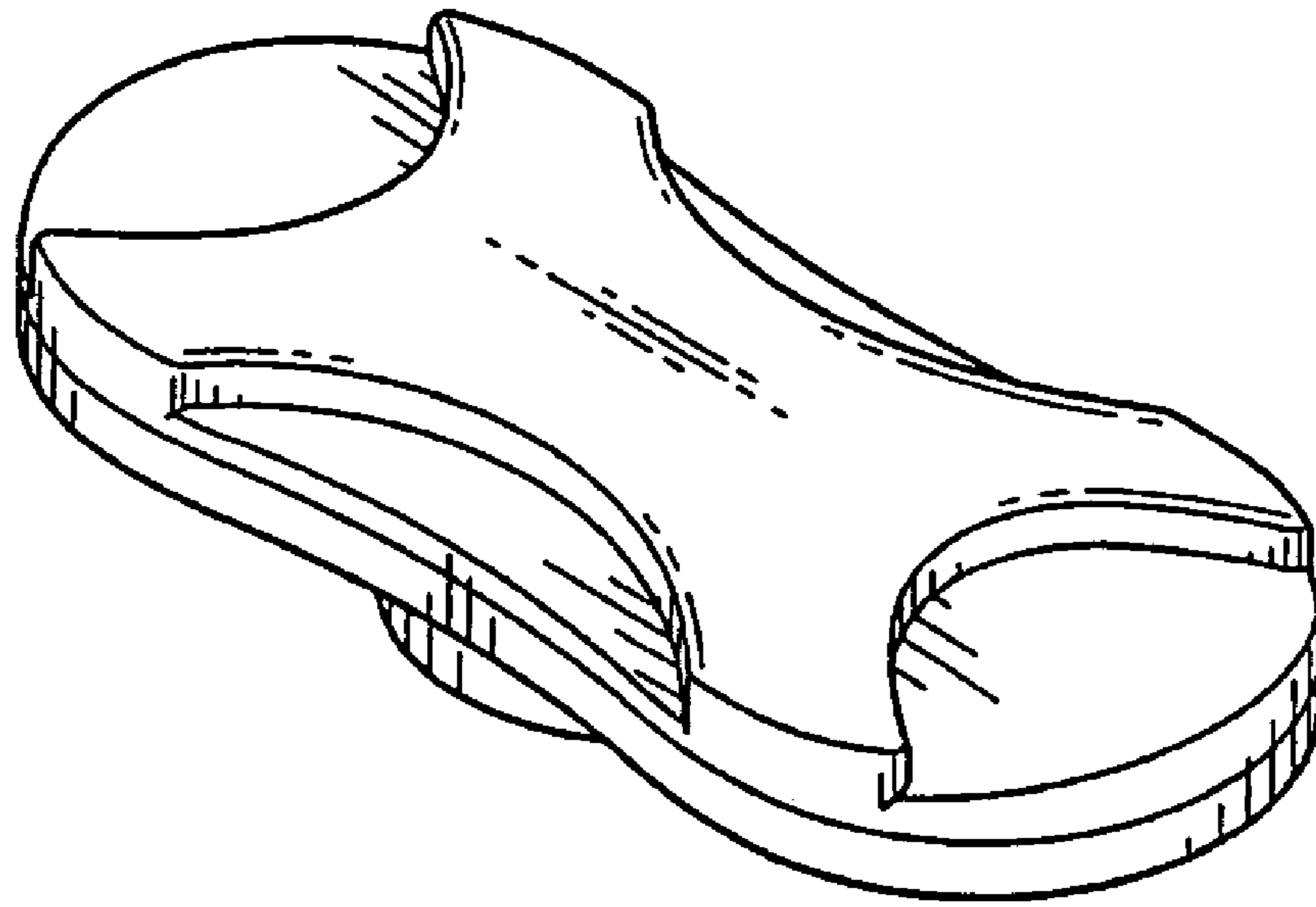

FIG. 1

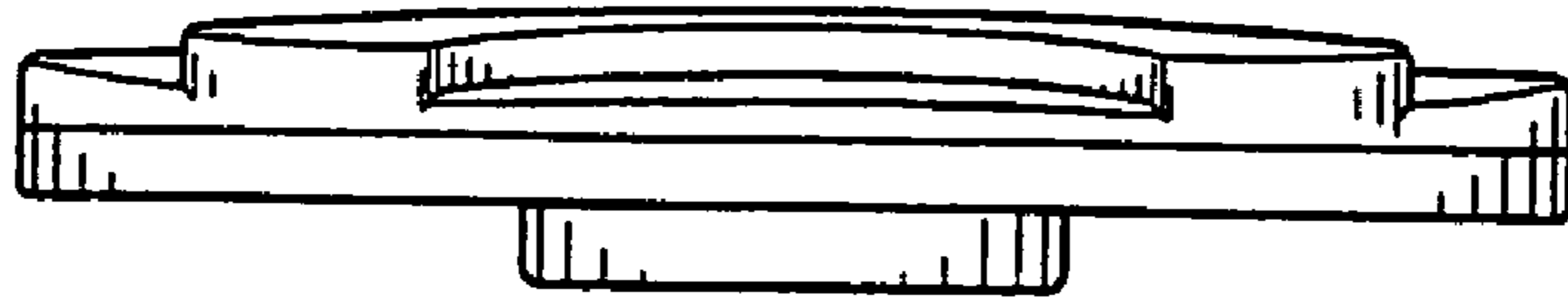

FIG. 2

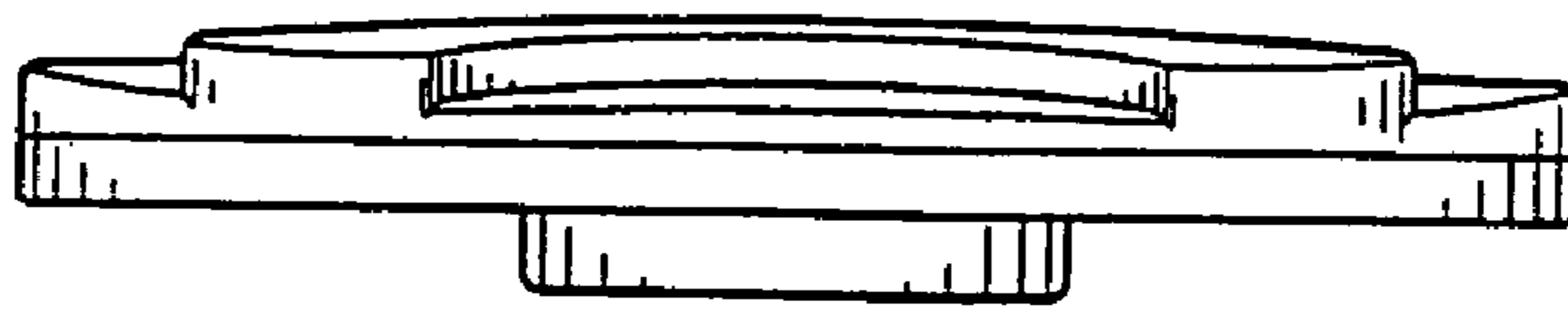

FIG. 3

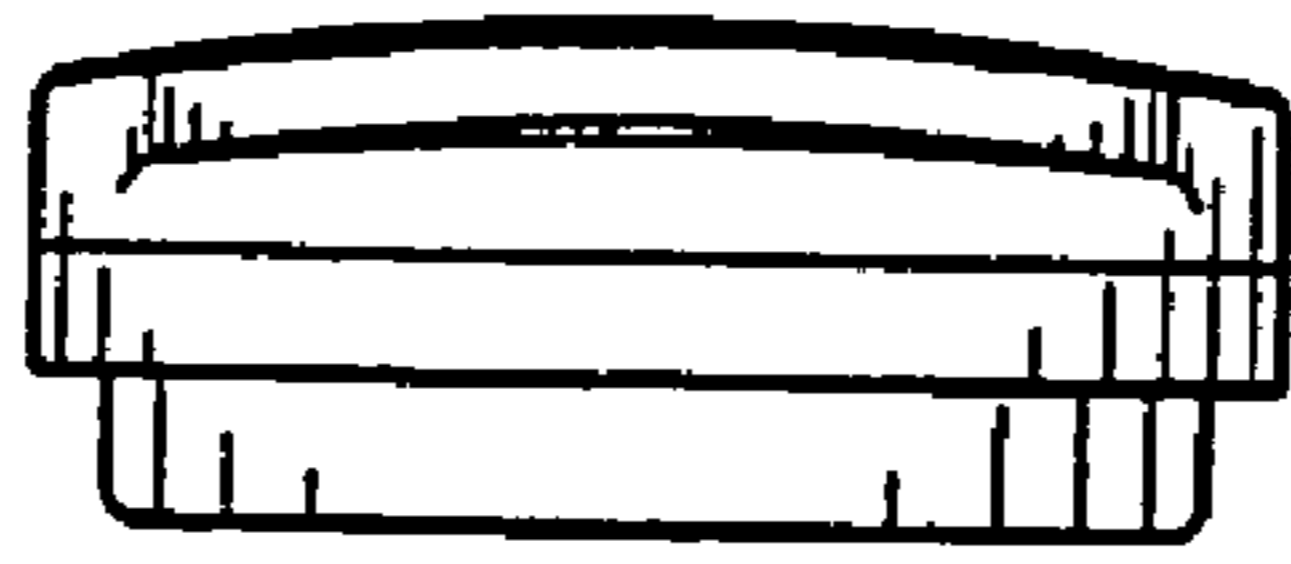

FIG. 4

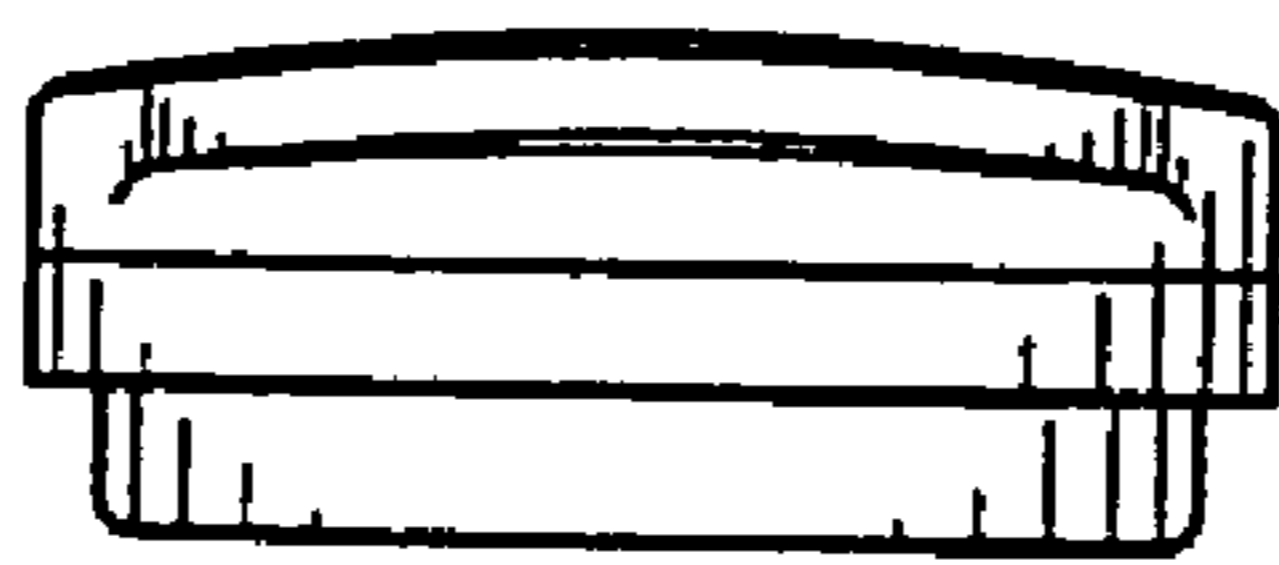

FIG. 5

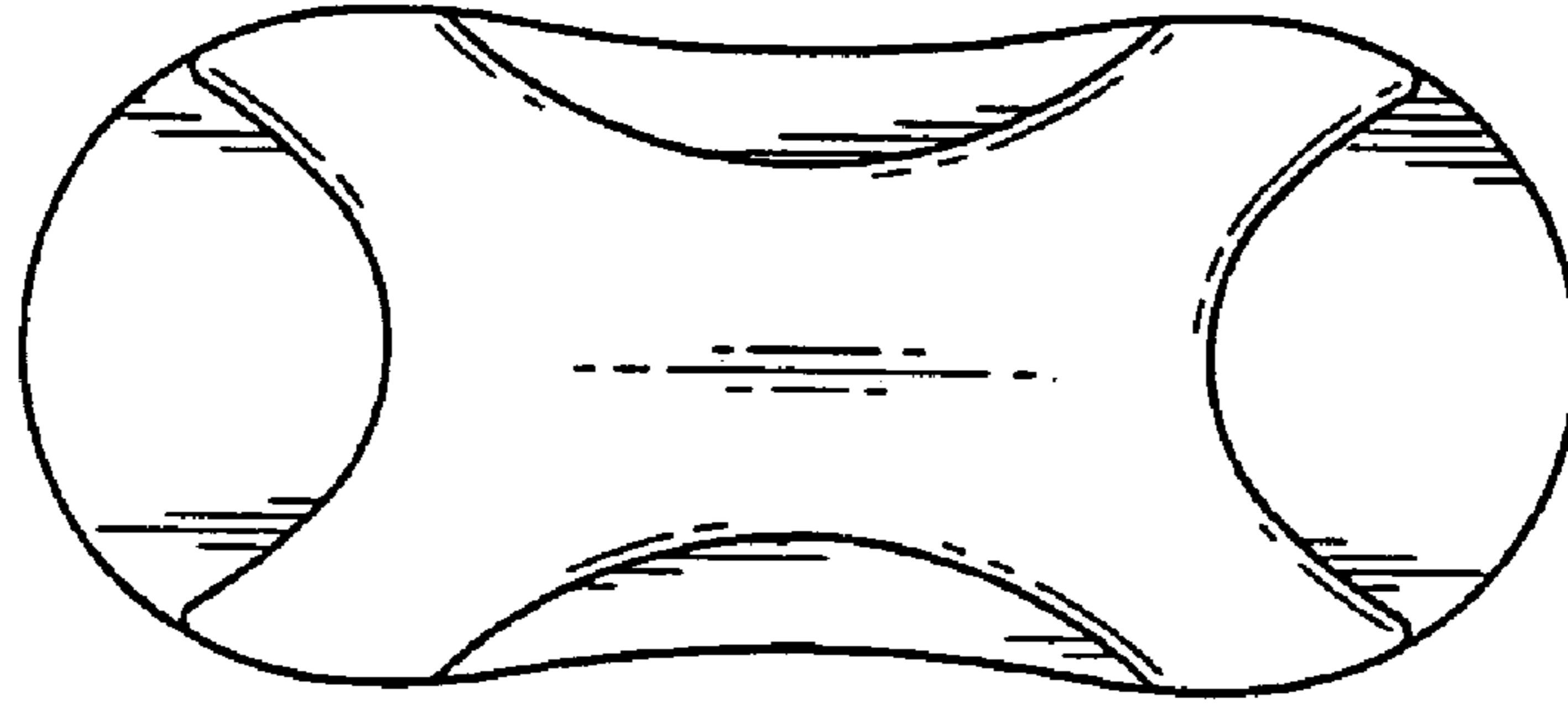

FIG. 6

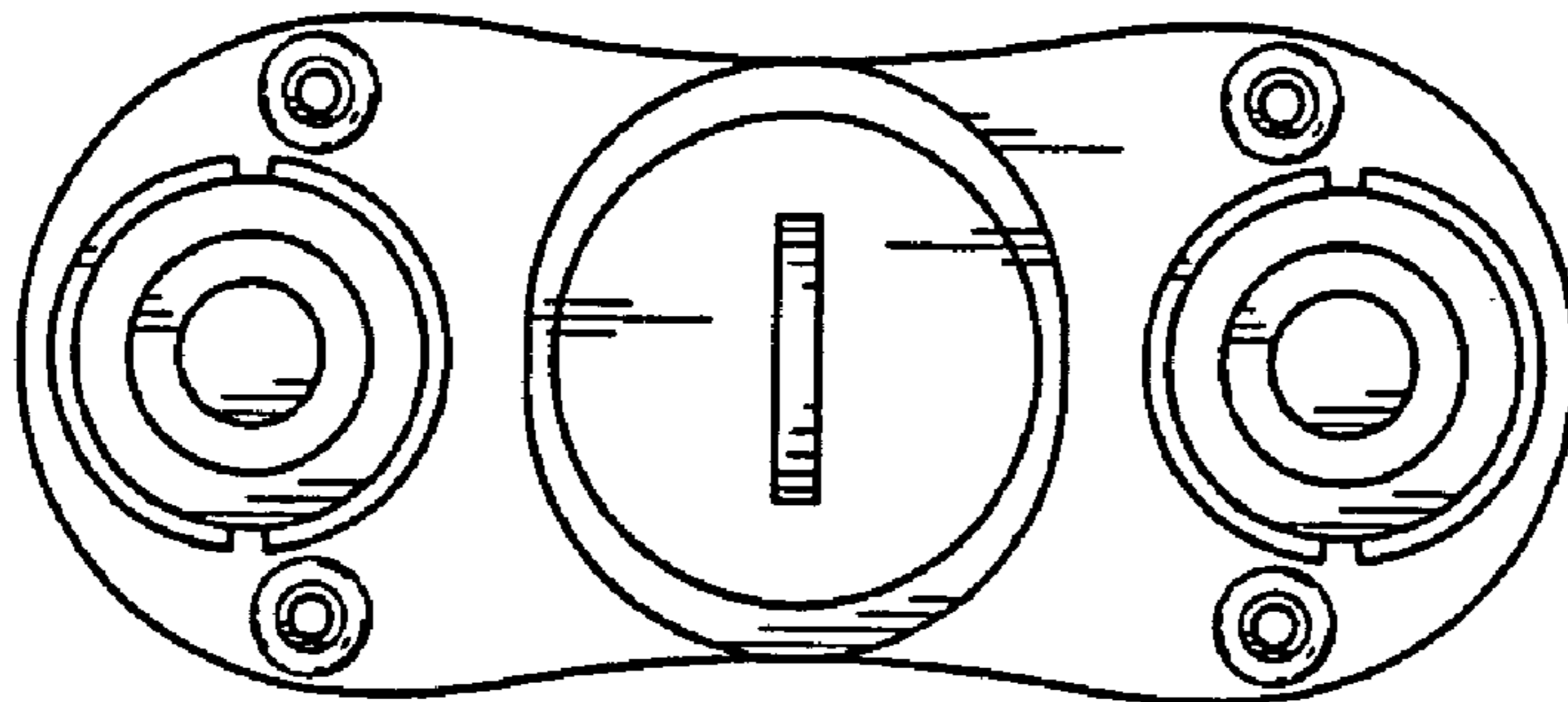

FIG. 7

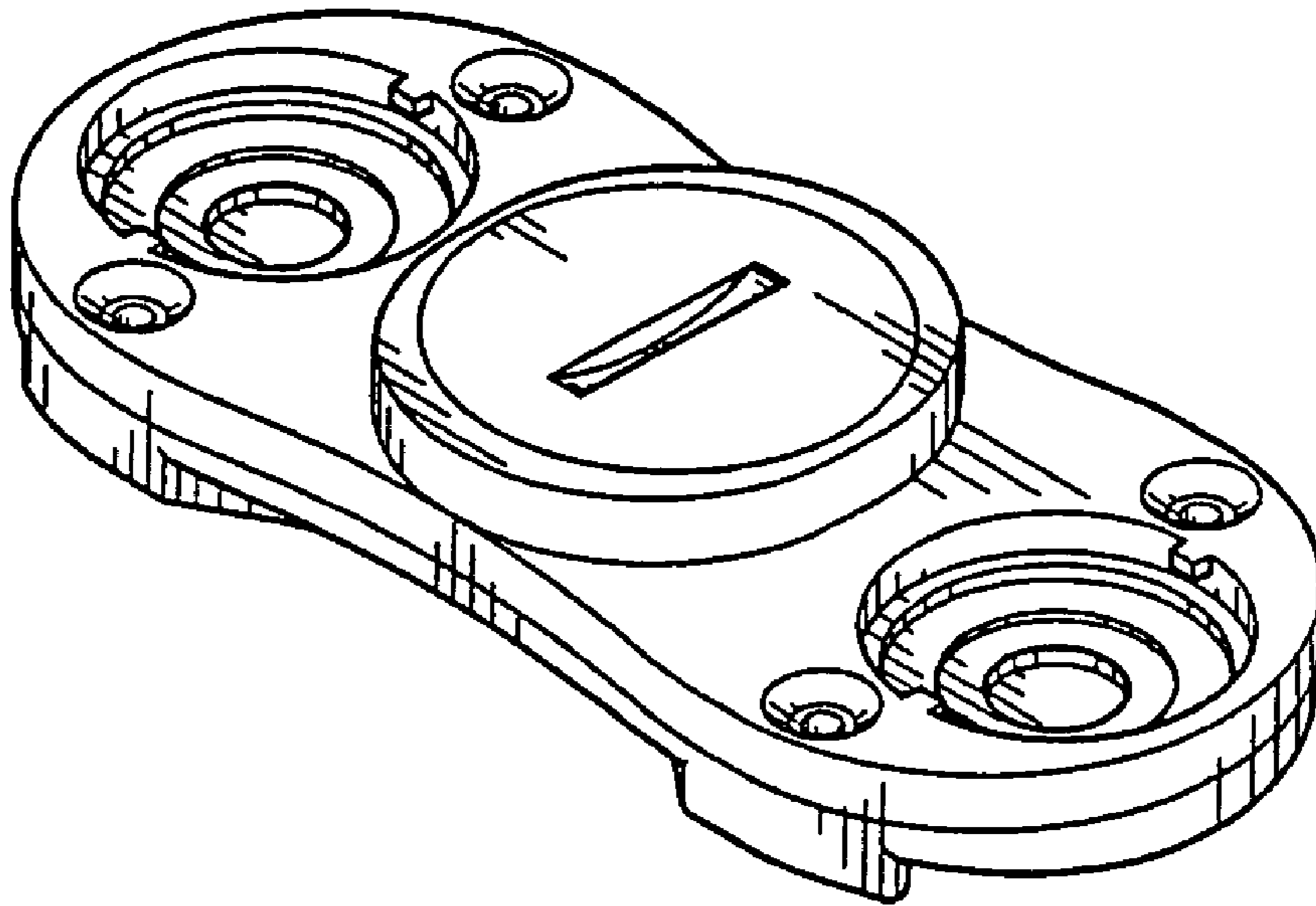

FIG. 8