



US00D557356S

(12) **United States Design Patent**
Johnston et al.

(10) **Patent No.:** **US D557,356 S**

(45) **Date of Patent:** **** Dec. 11, 2007**

(54) **WATER GUN**

(75) Inventors: **David Johnston**, East Haddam, CT
(US); **Brian Walsh**, Cheshire, CT (US)

(73) Assignee: **Jakks Pacific, Inc.**, Malibu, CA (US)

(**) Term: **14 Years**

(21) Appl. No.: **29/265,389**

(22) Filed: **Aug. 29, 2006**

(51) **LOC (8) Cl.** **21-01**

(52) **U.S. Cl.** **D21/572**

(58) **Field of Classification Search** D21/567-575,
D21/597, 599, 657; D22/103, 105; 446/267,
446/473, 175; 222/78-79; 239/211, 237,
239/329, 373; 124/6, 63-65, 73-75; D23/231
See application file for complete search history.

(56) **References Cited**

U.S. PATENT DOCUMENTS

D299,500 S * 1/1989 Geraci D21/599
5,009,413 A * 4/1991 Allen 446/153
D330,575 S * 10/1992 Kupperman D21/599
D334,955 S * 4/1993 Kupperman D21/599
5,928,053 A * 7/1999 Henderson 446/475

5,992,697 A * 11/1999 James 222/175
D451,229 S * 11/2001 Sehl D26/98
D471,948 S * 3/2003 Dehaan D21/572
D524,881 S * 7/2006 Orłowski et al. D21/572
D536,748 S * 2/2007 Chuang et al. D21/572

* cited by examiner

Primary Examiner—Holly H. Baynham

Assistant Examiner—Cynthia M. Chin

(74) *Attorney, Agent, or Firm*—Tope-McKay & Associates

(57) **CLAIM**

The ornamental design for a water gun, as shown and described.

DESCRIPTION

FIG. 1 is a front perspective view of a water gun;

FIG. 2 is a side elevational view thereof;

FIG. 3 is an opposite side view thereof;

FIG. 4 is a top plan view thereof;

FIG. 5 is a bottom plan view thereof;

FIG. 6 is an enlarged front elevational view thereof; and,

FIG. 7 is an enlarged rear elevational view thereof.

1 Claim, 7 Drawing Sheets

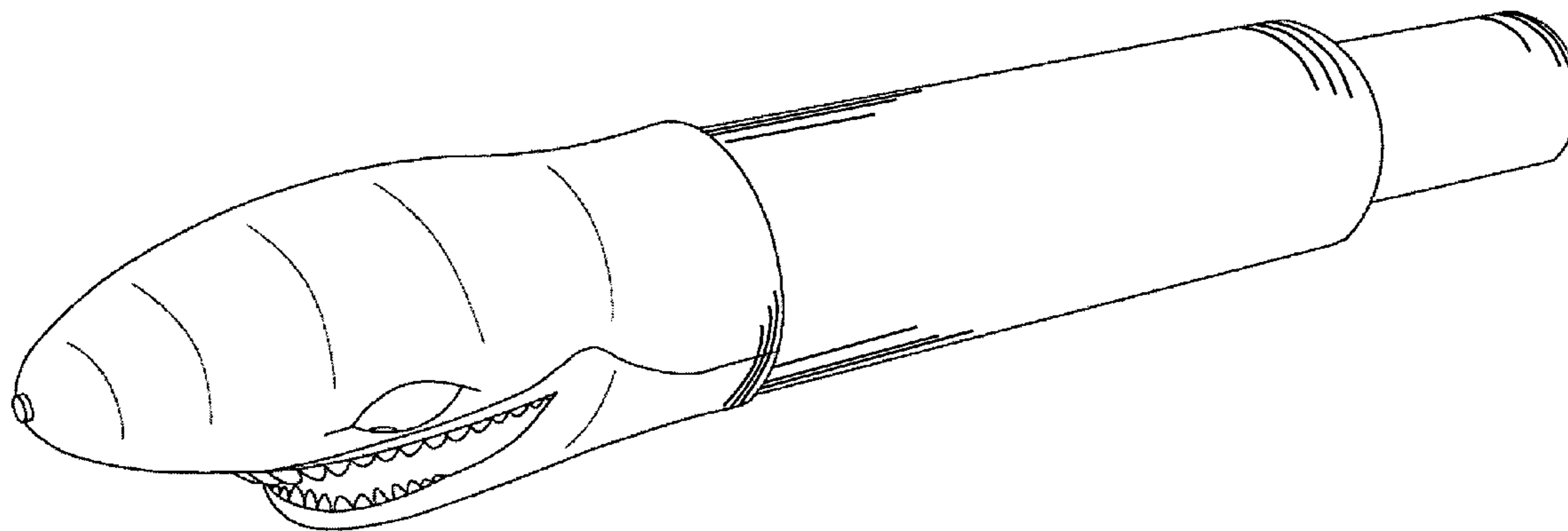

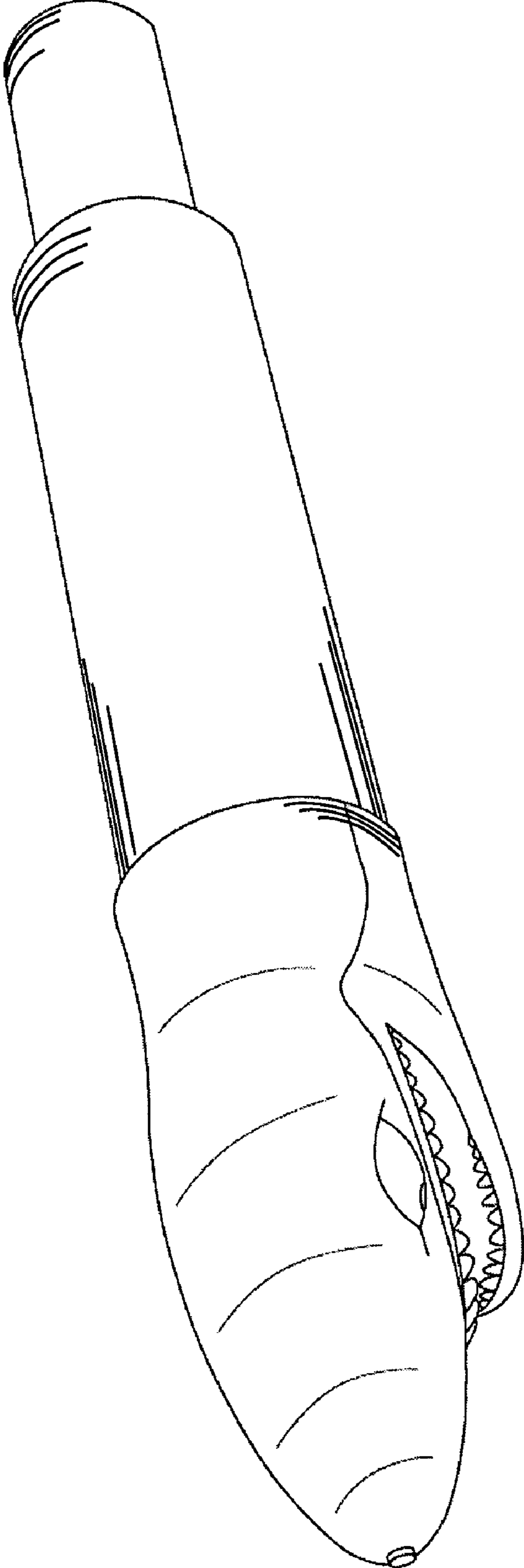

FIG. 1

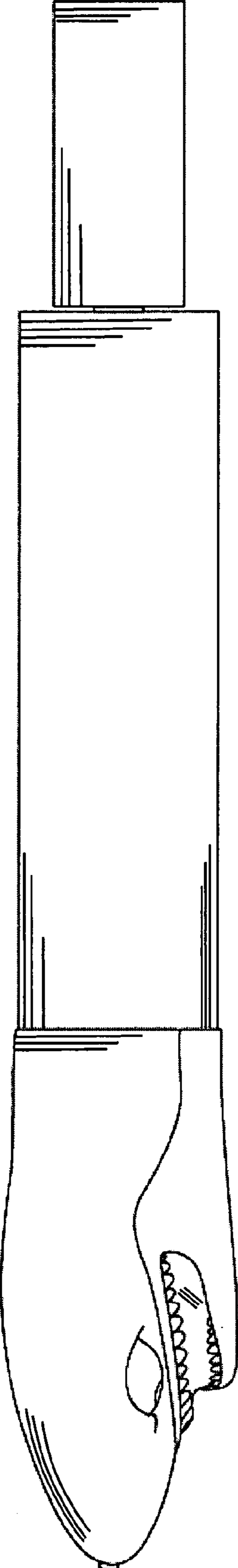

FIG. 2

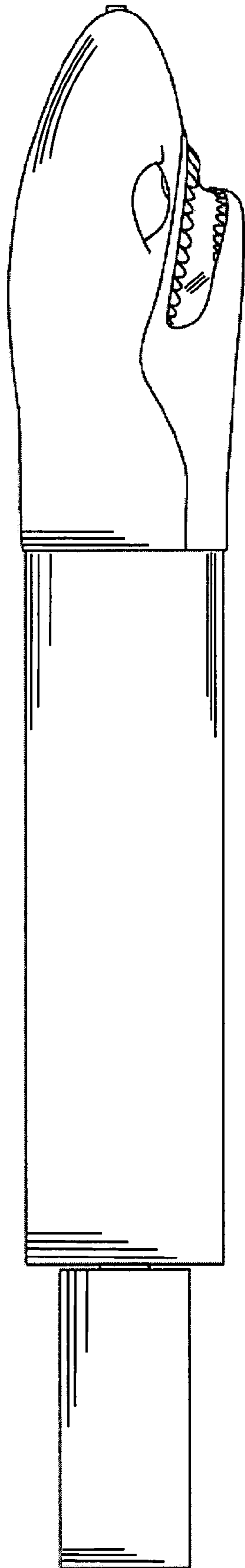

FIG. 3

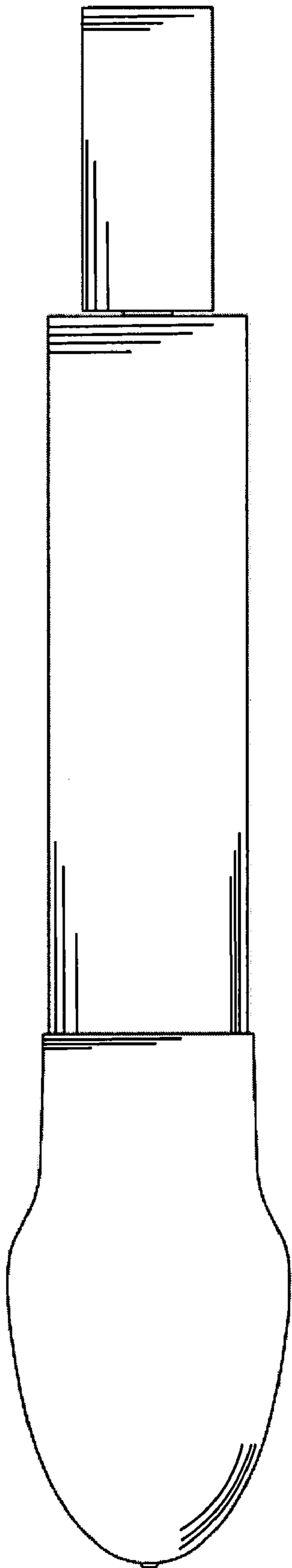

FIG. 4

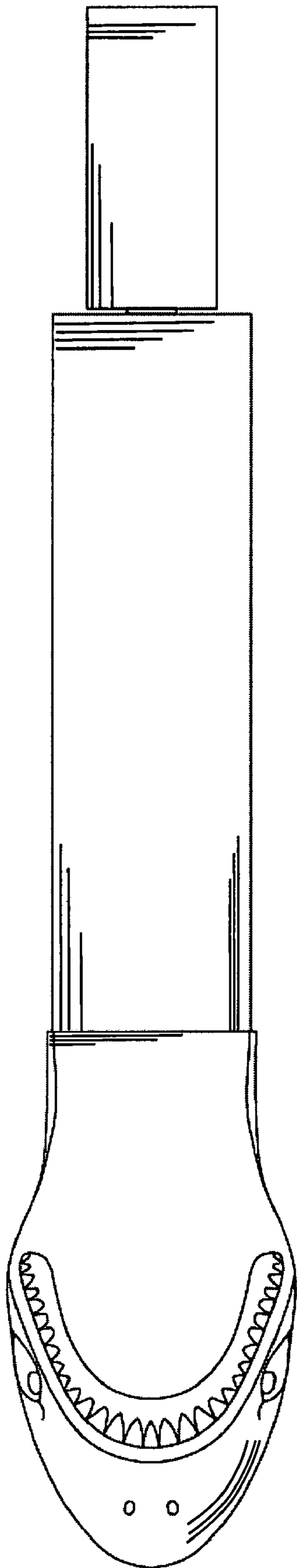

FIG. 5

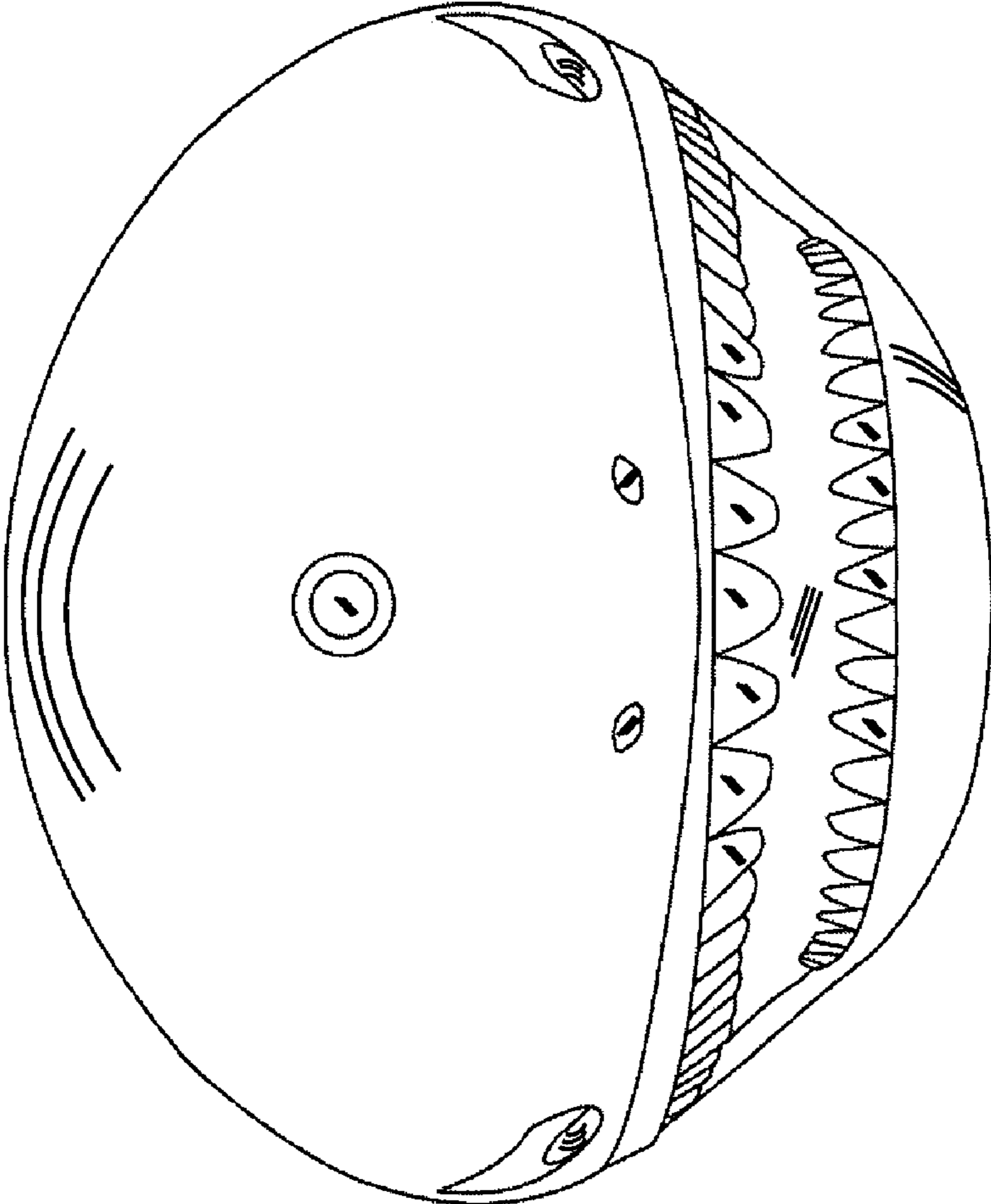

FIG. 6

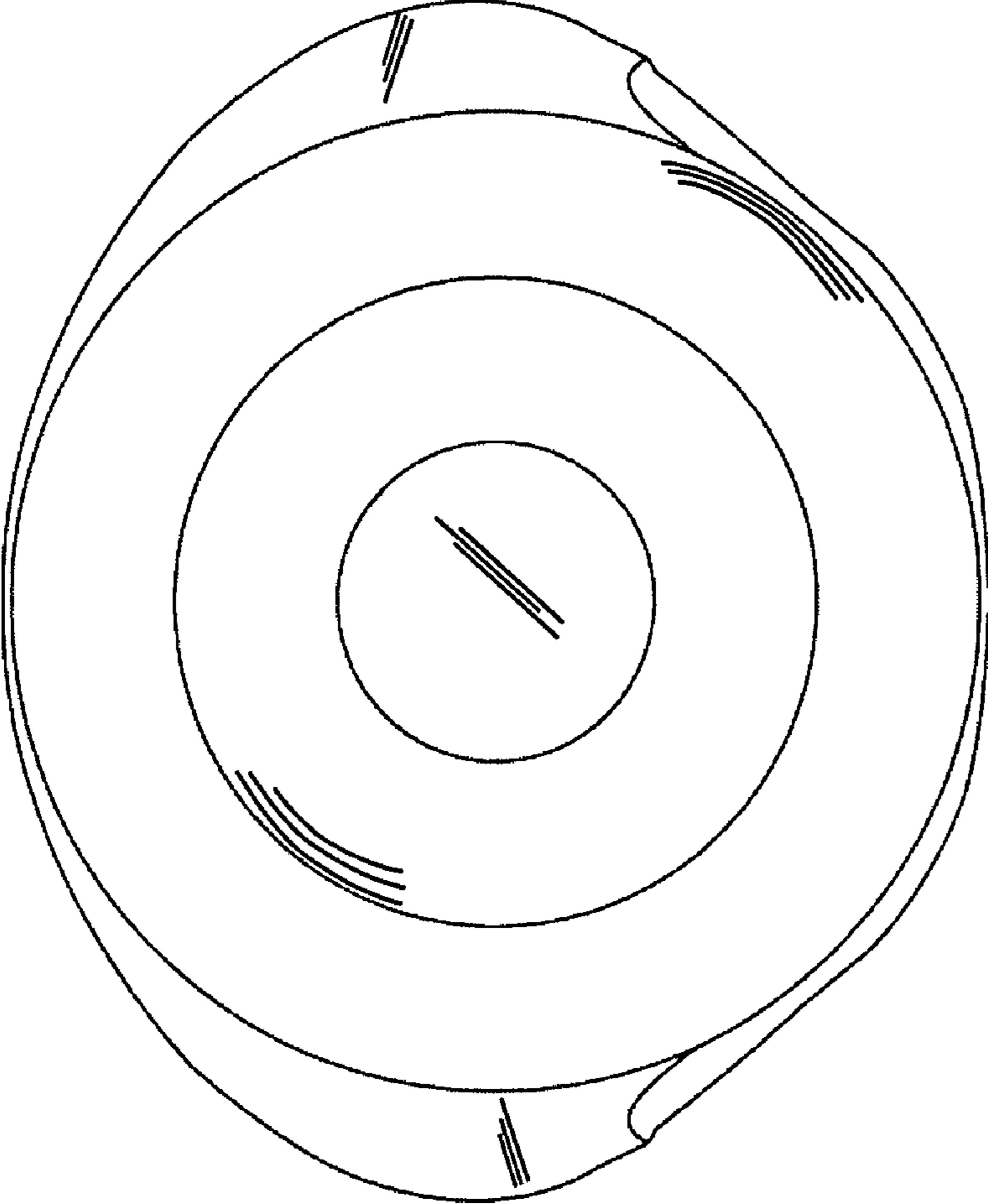

FIG. 7