



US00D557266S

(12) **United States Design Patent**
Hughes

(10) **Patent No.:** **US D557,266 S**

(45) **Date of Patent:** **** Dec. 11, 2007**

(54) **MONITOR AND PRINTER STAND**

(75) Inventor: **William Scott Hughes**, Chicago, IL
(US)

(73) Assignee: **Sanford, L.P.**, Oak Brook, IL (US)

(**) Term: **14 Years**

(21) Appl. No.: **29/259,108**

(22) Filed: **May 2, 2006**

(51) **LOC (8) Cl.** **14-03**

(52) **U.S. Cl.** **D14/451**

(58) **Field of Classification Search** D14/224,
D14/239, 251, 253, 316, 375, 376, 432, 439,
D14/447, 448, 451, 452, 457; D6/444, 513,
D6/396, 449, 510, 511; D8/349, 355, 363,
D8/373, 380; 248/121, 124.1, 127, 176.1,
248/177.1, 201, 205.1, 274.1, 276.1, 291.1,
248/309.1, 313, 346.01, 346.03, 371, 415,
248/917-24; 312/223.3; 348/825, 836;
379/446, 454; 211/134, 151; 108/51.11;
D18/59

See application file for complete search history.

(56) **References Cited**

U.S. PATENT DOCUMENTS

D285,632 S *	9/1986	Axhamre	D6/474
D287,678 S *	1/1987	Hatcher et al.	D6/474
D300,291 S *	3/1989	Naes	D6/474
D308,537 S *	6/1990	Clark	D18/59
4,931,978 A *	6/1990	Drake et al.	361/680
D316,710 S *	5/1991	Drake et al.	D14/447
D319,463 S *	8/1991	Clyburn	D18/59
5,213,401 A *	5/1993	Hatcher	312/208.1
D362,358 S *	9/1995	Hatcher	D6/449
D364,290 S *	11/1995	Watts	D6/474
D370,366 S *	6/1996	Watts	D6/449

D376,787 S *	12/1996	Calfee	D14/451
6,036,288 A *	3/2000	Shih	312/223.3
6,474,614 B2	11/2002	MacEachern	248/349.1
6,490,154 B2	12/2002	Thompson	361/686
6,682,040 B1	1/2004	MacEachern	248/349.1

OTHER PUBLICATIONS

Computer Stand available at http://web.archive.org/web/20051103141107/http://mc3llc.com/prodimages/CA220L_LR.jpg*

Undated renderings of general product concepts disclosed more than one year before May 2, 2006.

* cited by examiner

Primary Examiner—Cathron C. Brooks

Assistant Examiner—Angela Lee

(74) *Attorney, Agent, or Firm*—Marshall Gerstein & Borun LLP

(57) **CLAIM**

The ornamental design for a monitor and printer stand, as shown and described.

DESCRIPTION

FIG. 1 is a perspective view showing my new design for a monitor and printer stand;

FIG. 2 is a front view of the stand of FIG. 1;

FIG. 3 is a side view of the stand of FIG. 1, the opposite side being a mirror image thereof;

FIG. 4 is a top plan view of the stand of FIG. 1;

FIG. 5 is a bottom plan view of the stand of FIG. 1; and,

FIG. 6 is a rear view of the stand of FIG. 1.

The dashed lines are for illustrative purposes only and form no part of the claimed design.

1 Claim, 5 Drawing Sheets

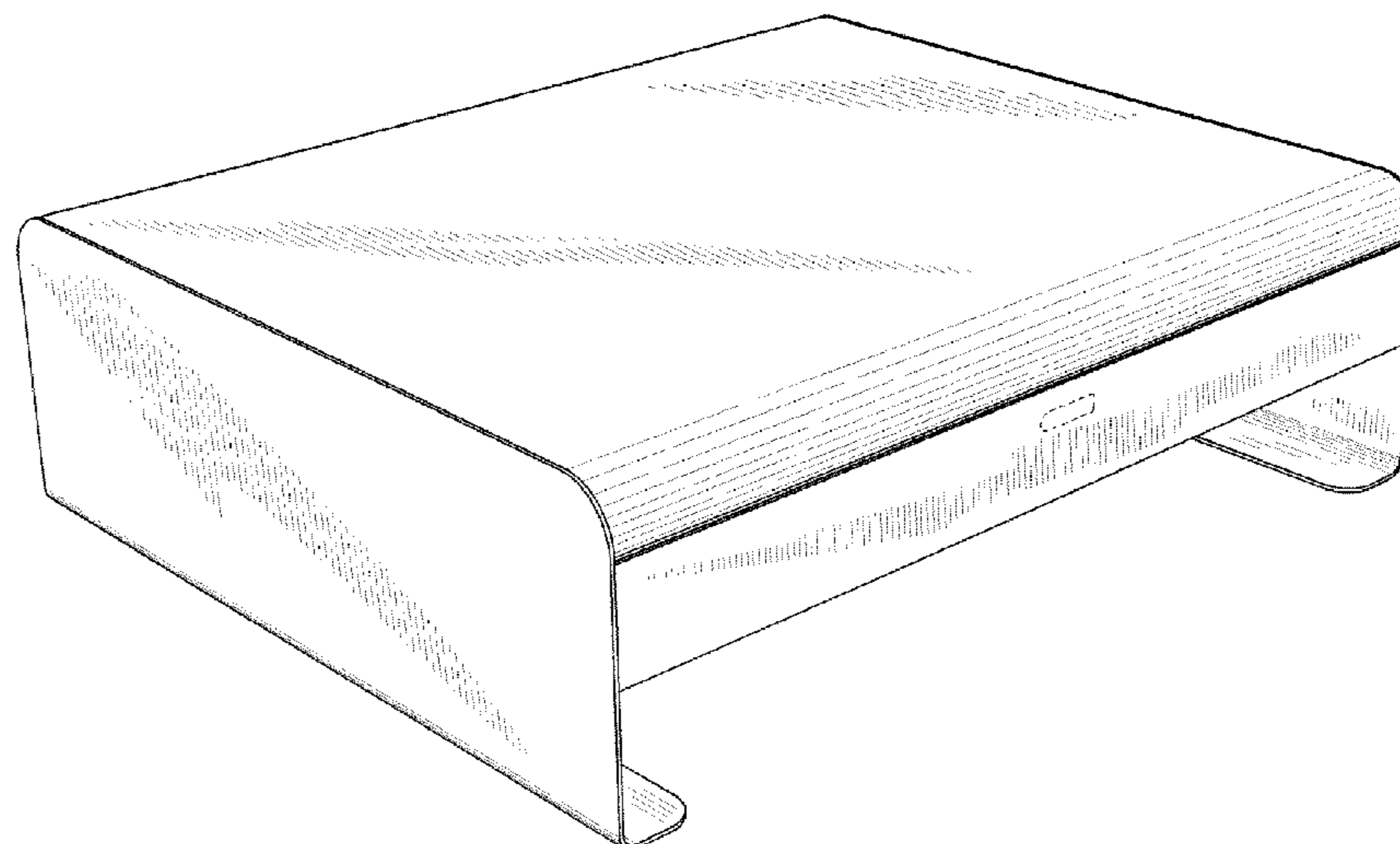

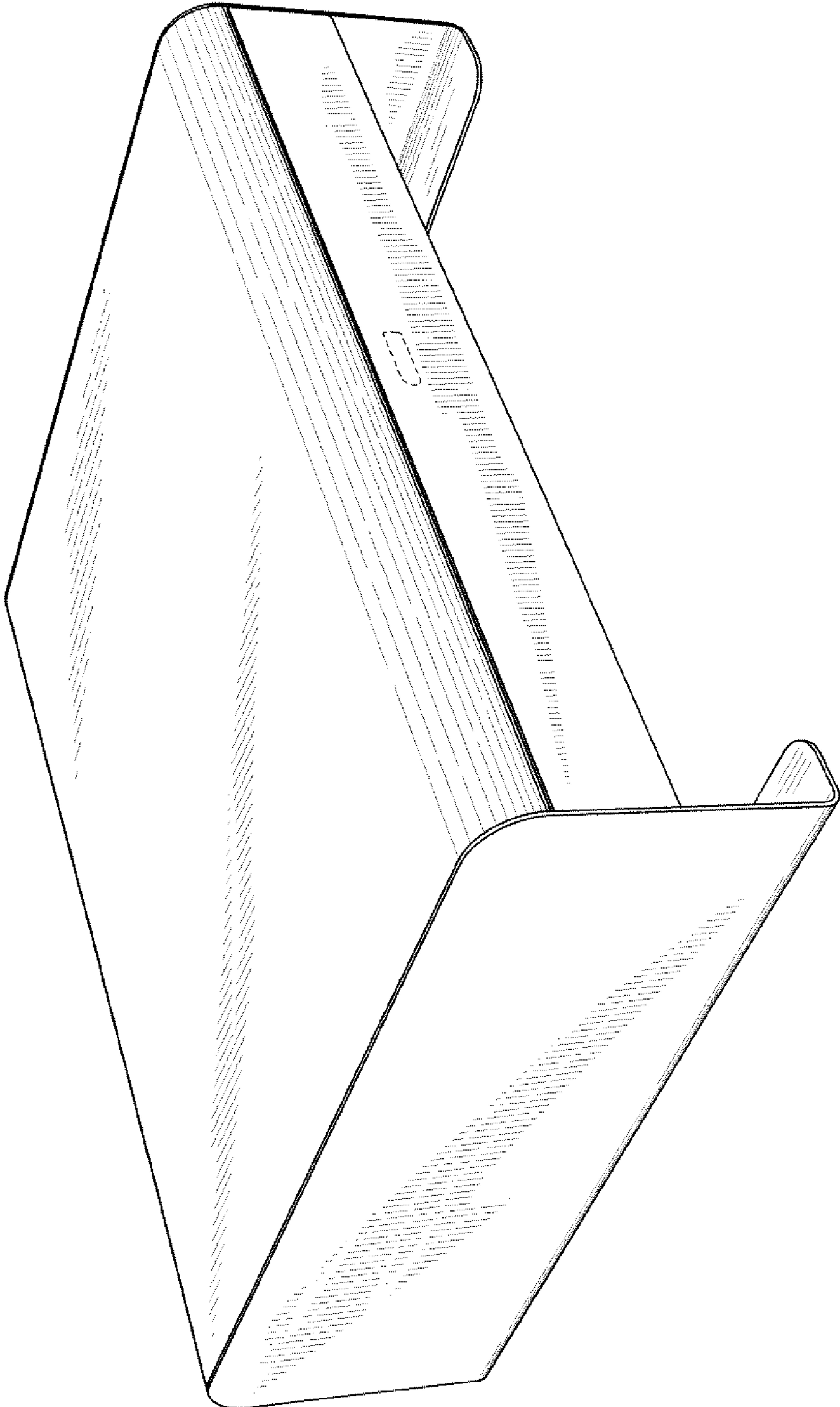

FIG. 1

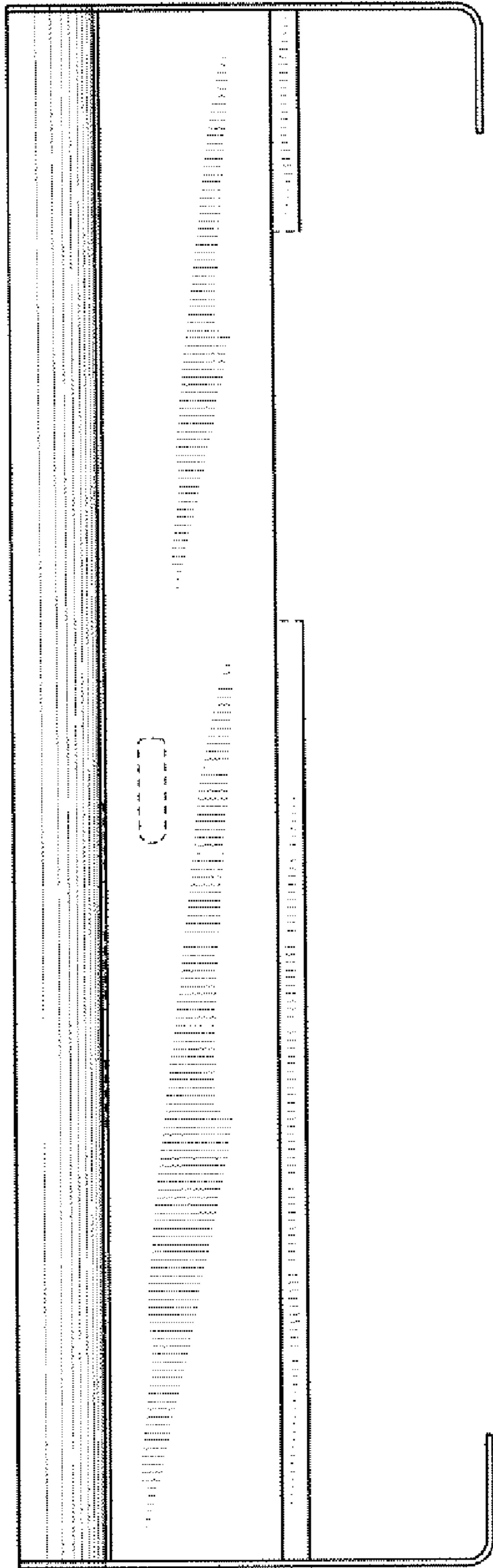

FIG. 2

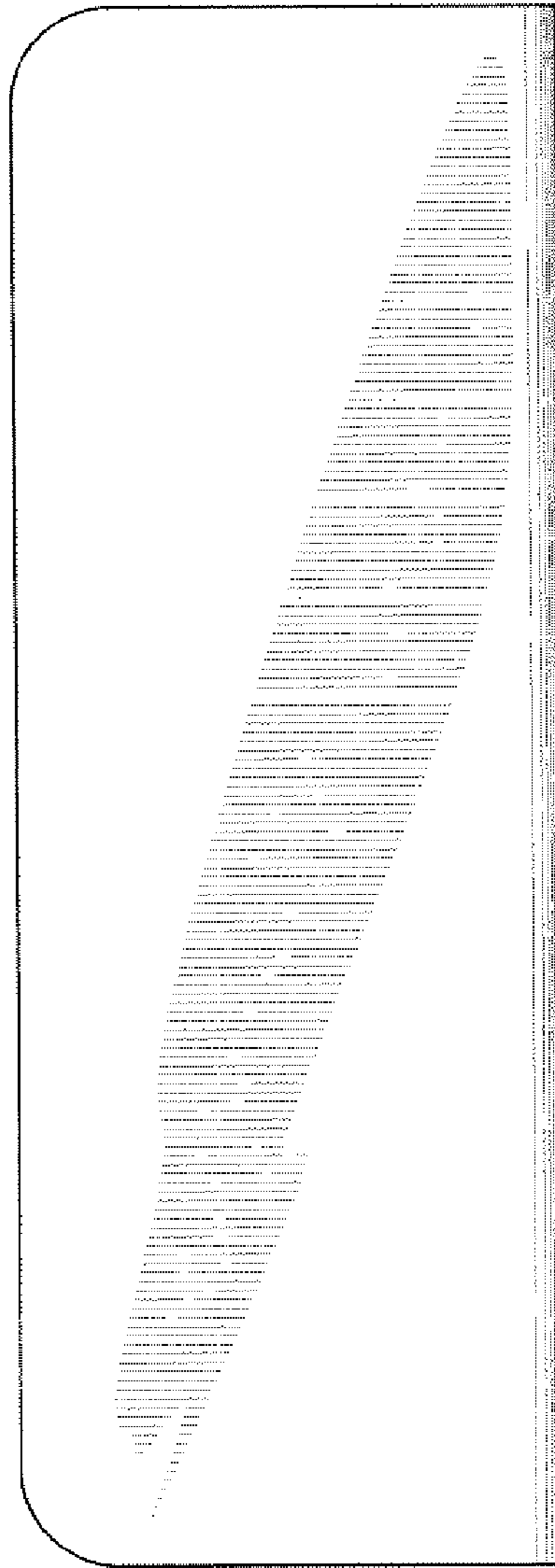

FIG. 3

FIG. 4

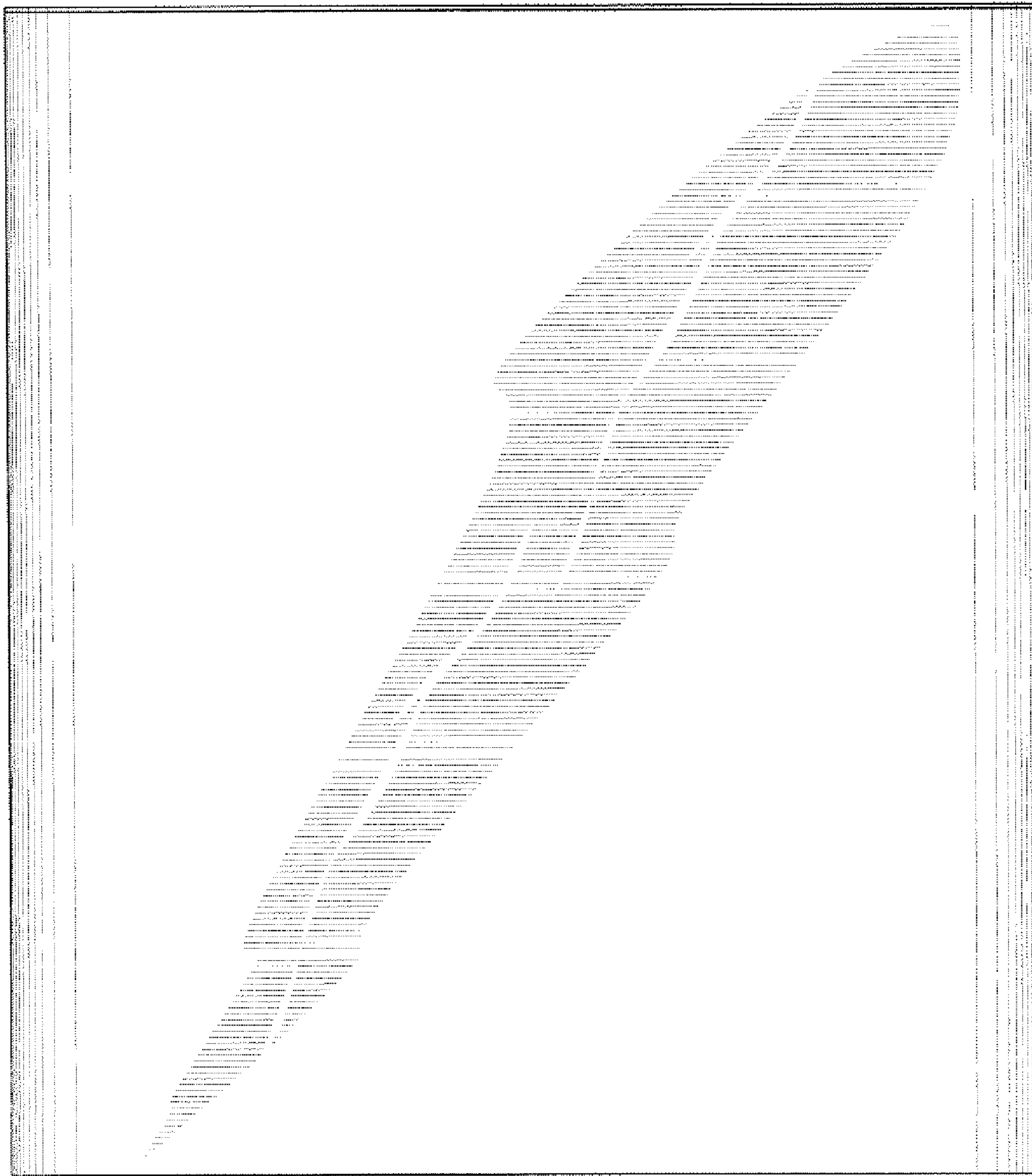
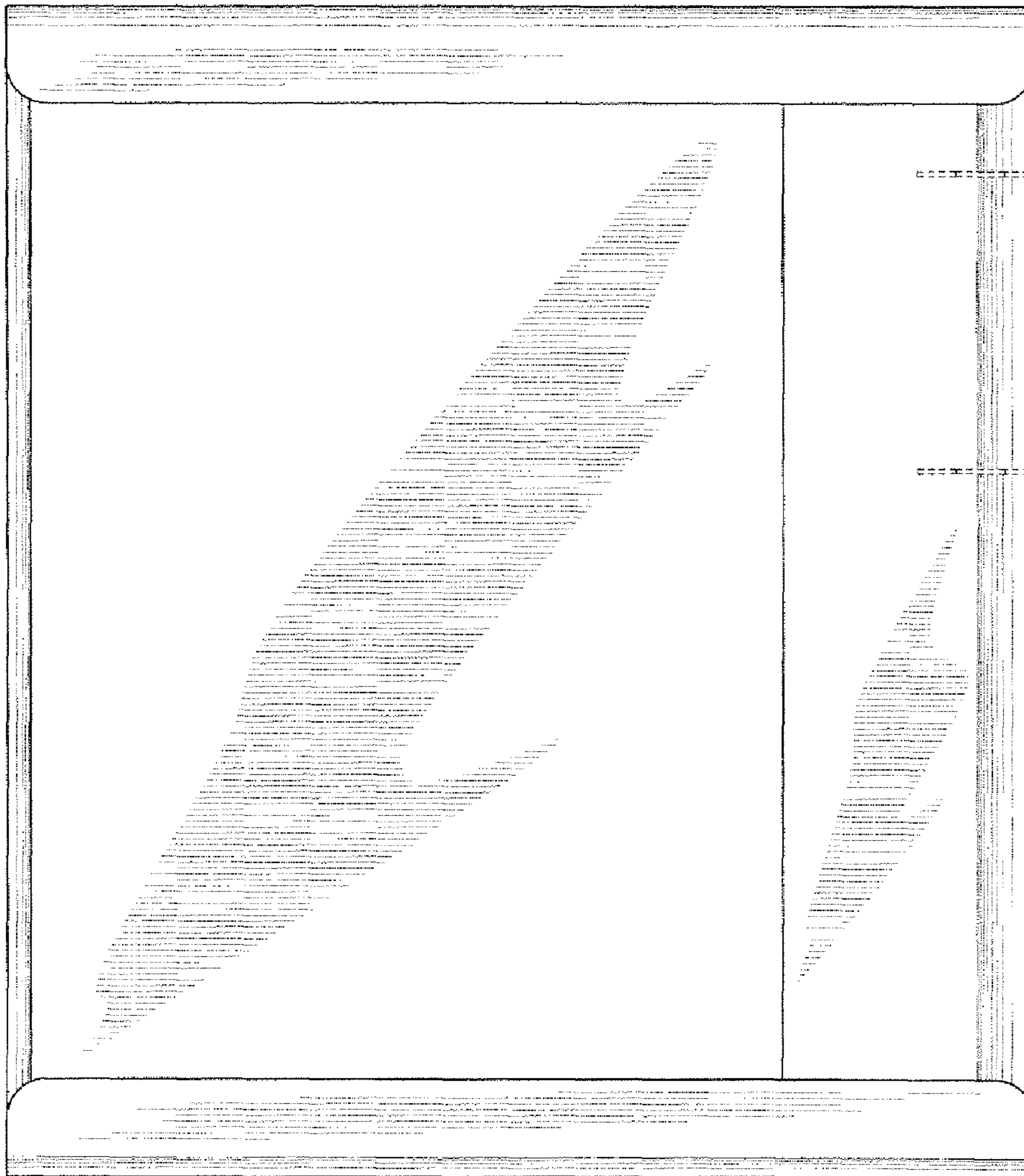

FIG. 5



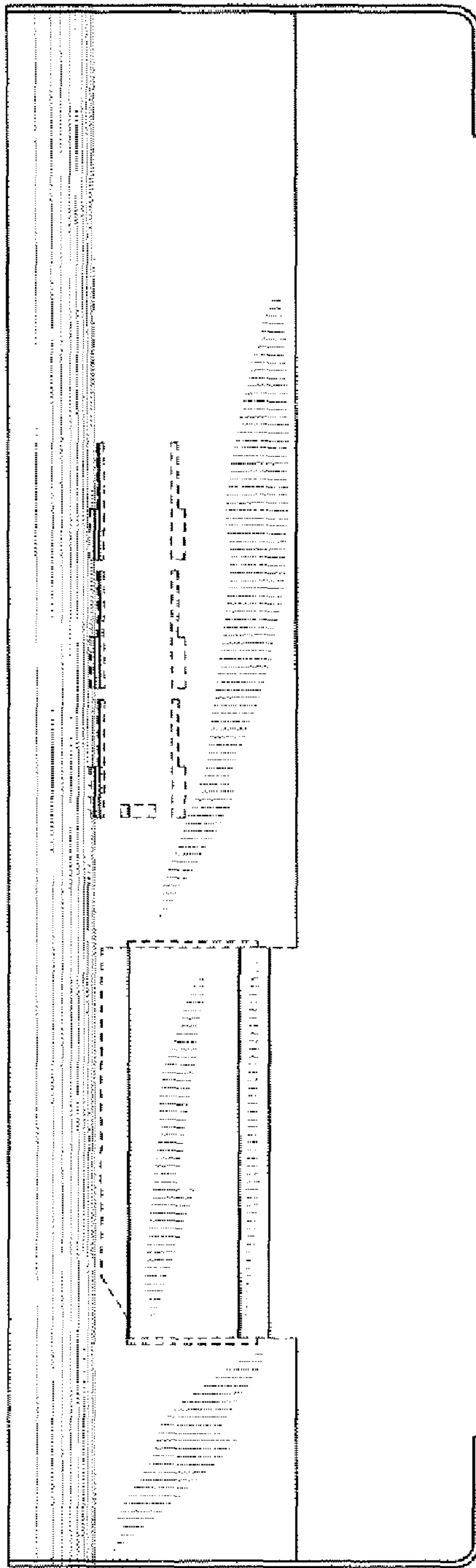

FIG. 6