



US00D557247S

(12) **United States Design Patent** (10) **Patent No.:** **US D557,247 S**
Keenan (45) **Date of Patent:** **** Dec. 11, 2007**

(54) **CELL PHONE BOOTH**

(76) Inventor: **Julie A. Keenan**, 6945 Kingsland,
Shelby Township, MI (US) 48317

(**) Term: **14 Years**

(21) Appl. No.: **29/253,001**

(22) Filed: **Jan. 31, 2006**

(51) **LOC (8) Cl.** **14-03**

(52) **U.S. Cl.** **D14/140.2; D14/143; D25/16**

(58) **Field of Classification Search** D14/138,
D14/140.2, 143, 299, 496; D25/16; 52/27.5,
52/27, 28
See application file for complete search history.

(56) **References Cited**

U.S. PATENT DOCUMENTS

D192,630 S *	4/1962	Sherron	D25/16
D270,726 S *	9/1983	Weiss	D14/143
D337,831 S *	7/1993	McNamara et al.	D25/16
D361,334 S	8/1995	Chan		
D367,065 S	2/1996	Wu		
D370,681 S	6/1996	Diamond		
D381,664 S	7/1997	Williams et al.		
D412,209 S *	7/1999	Hunt	D25/16
D416,914 S	11/1999	Lummis		
D432,661 S *	10/2000	Caya	D25/16
D439,577 S *	3/2001	Smith	D14/140.2

OTHER PUBLICATIONS

British Telephone Booth; author unknown; date unknown.
American Telephone Booth; author unknown; date unknown.

* cited by examiner

Primary Examiner—Terry A Wallace
(74) *Attorney, Agent, or Firm*—Harness, Dickey & Pierce,
PLC

(57) **CLAIM**

The ornamental design for a cell phone booth, as shown and described.

DESCRIPTION

FIG. 1 is a perspective view of a cell phone booth in accordance with the present teachings;

FIG. 2 is similar to FIG. 1 and shows a door of the cell phone booth open;

FIG. 3 is a front view of the cell phone booth of FIG. 1;

FIG. 4 is a side view of the cell phone booth of FIG. 1;

FIG. 5 is a side view of the cell phone booth of FIG. 1 and shows the door open;

FIG. 6 is a rear view of the cell phone booth; and,

FIG. 7 is a top view of the cell phone booth with the door open, a bottom view is excluded as the bottom is flat and devoid of surface ornamentation.

The broken lines are for illustrative purposes only and form no part of the claimed design. The “TELEPHONE” text being shown with broken lines is for illustrative purposes only and forms no part of the claimed design.

1 Claim, 7 Drawing Sheets

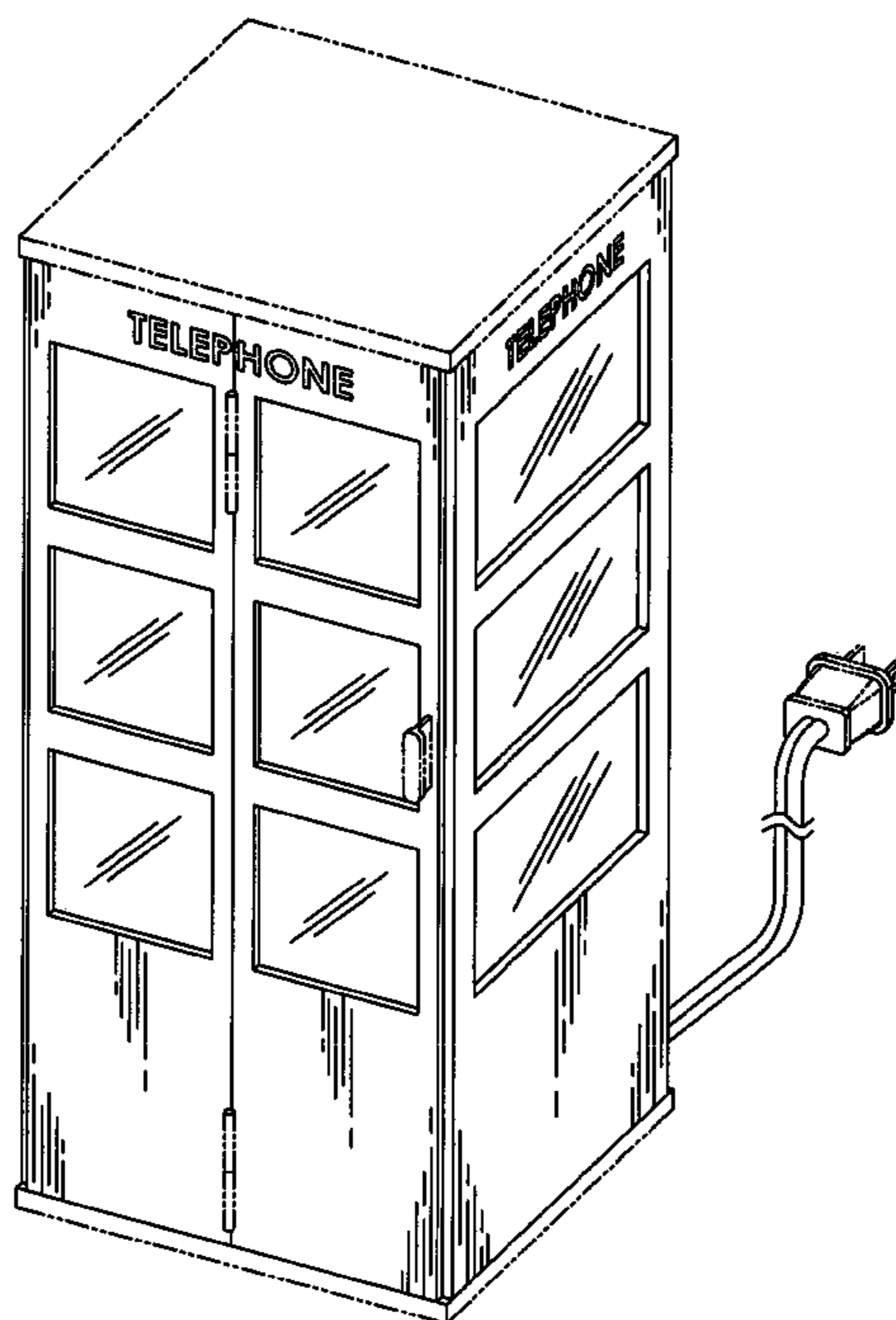

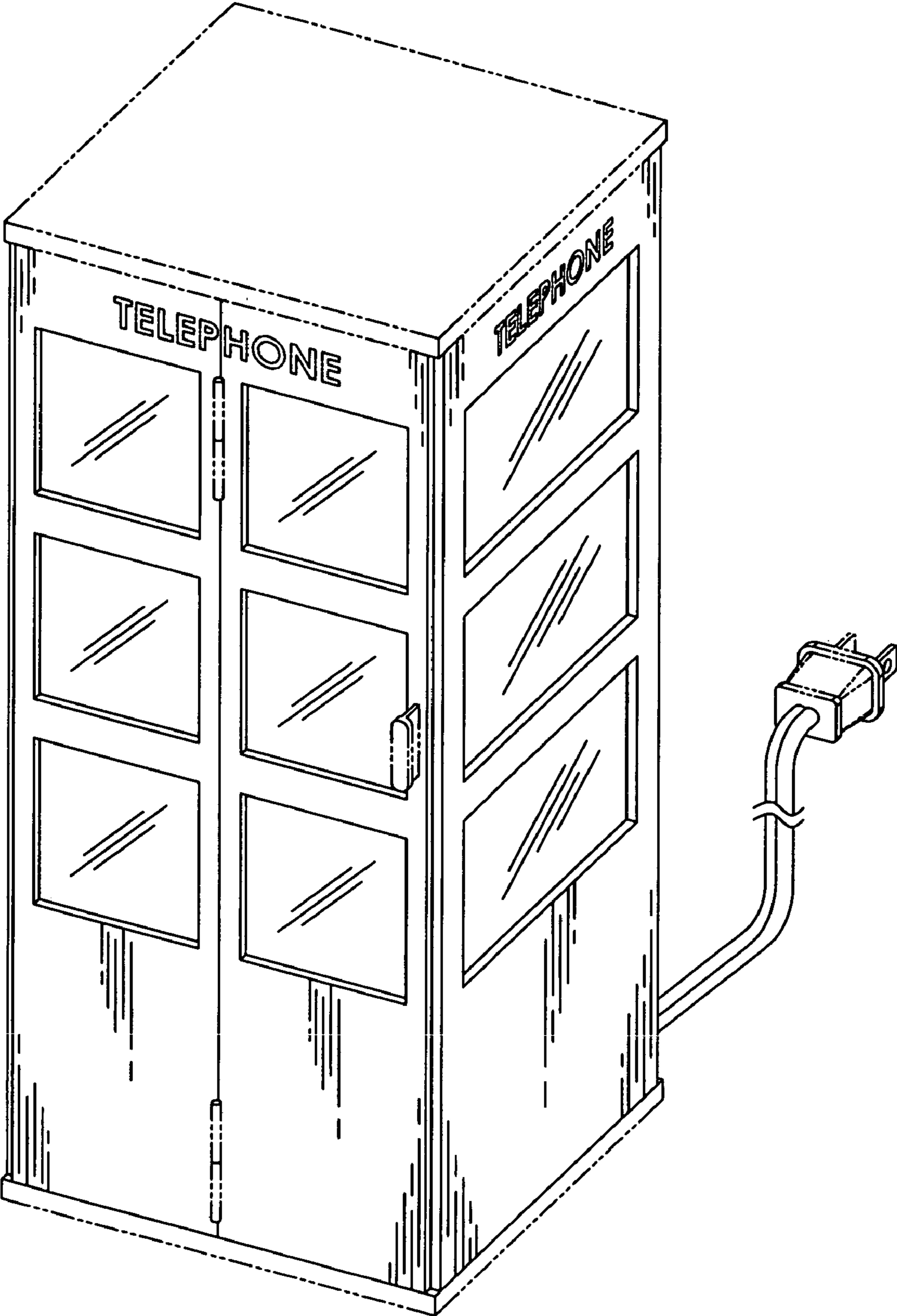

FIG 1

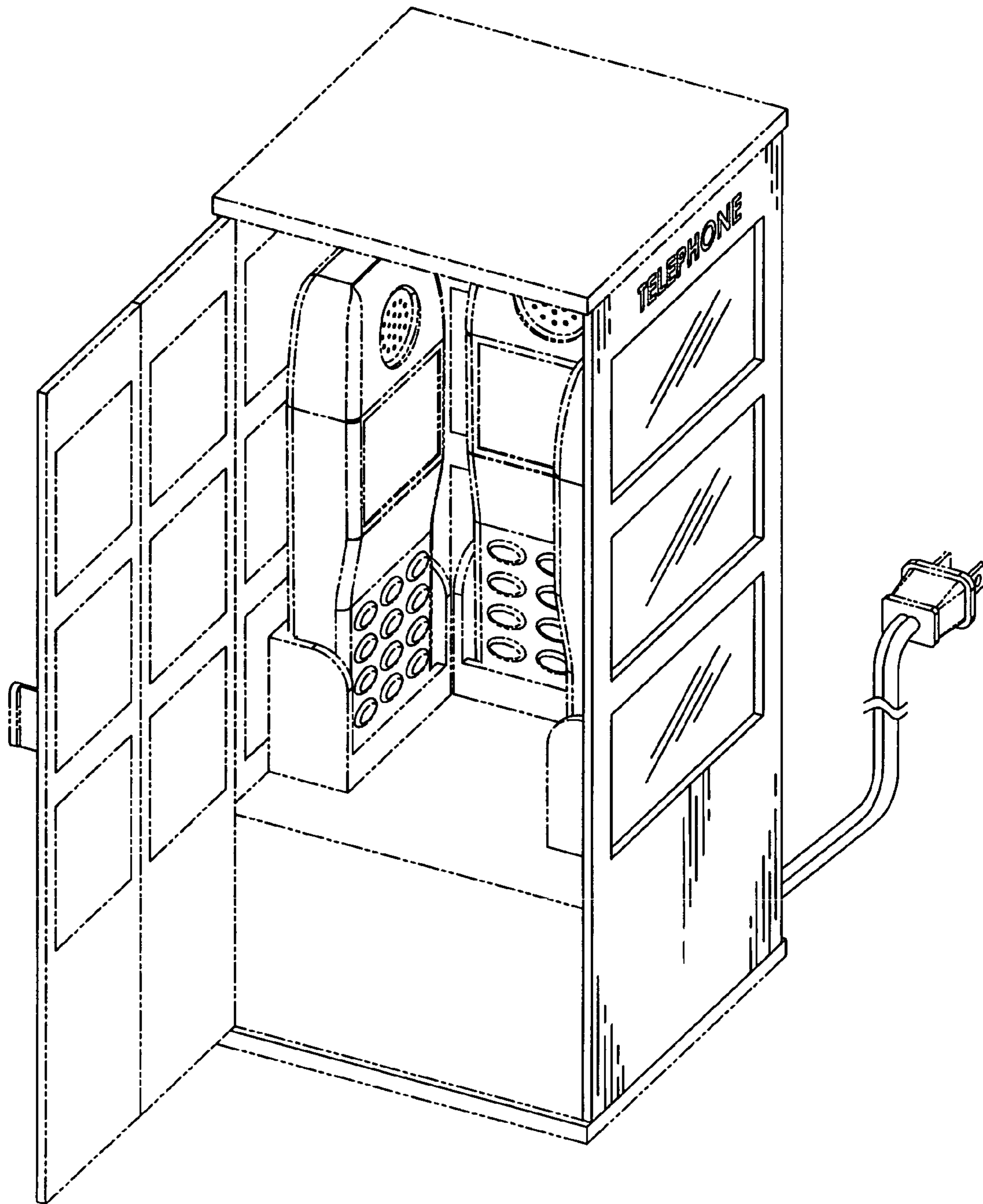

FIG 2

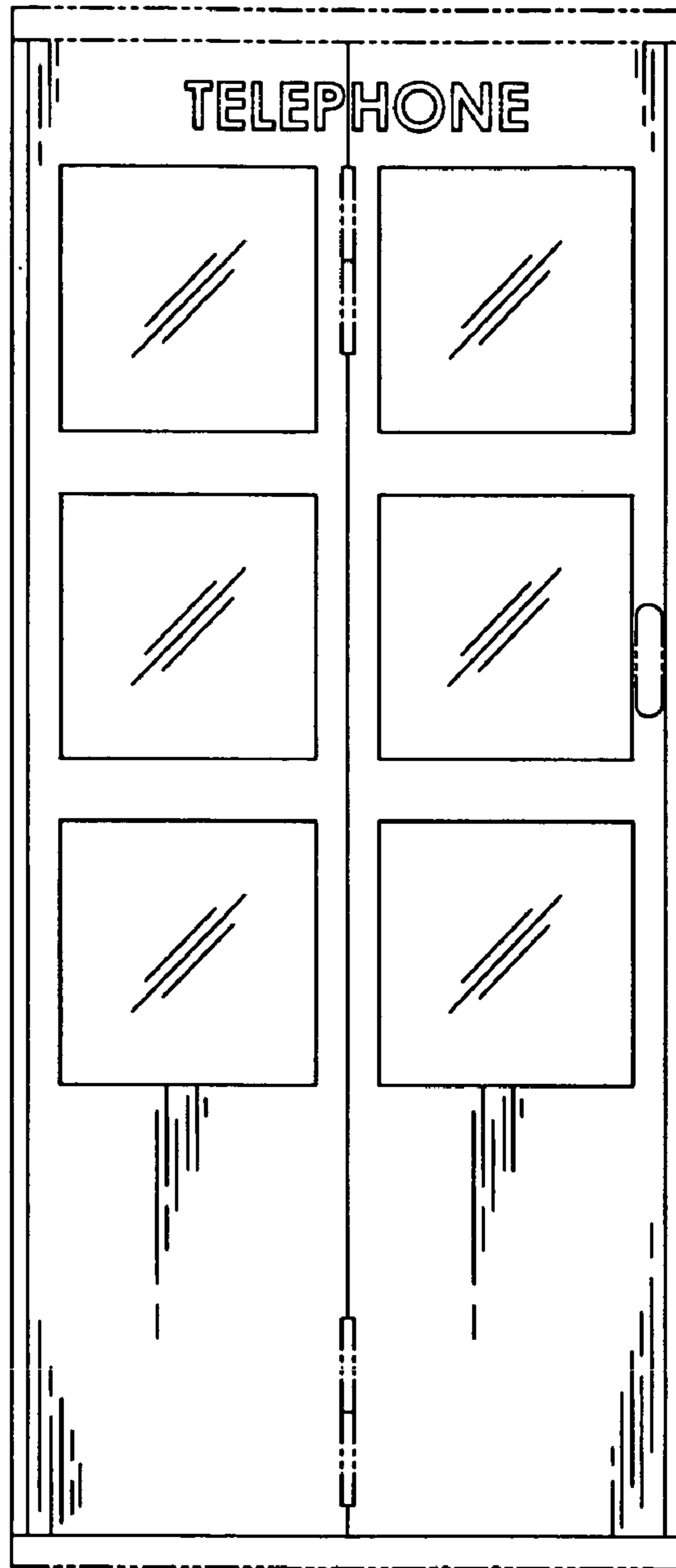

FIG 3

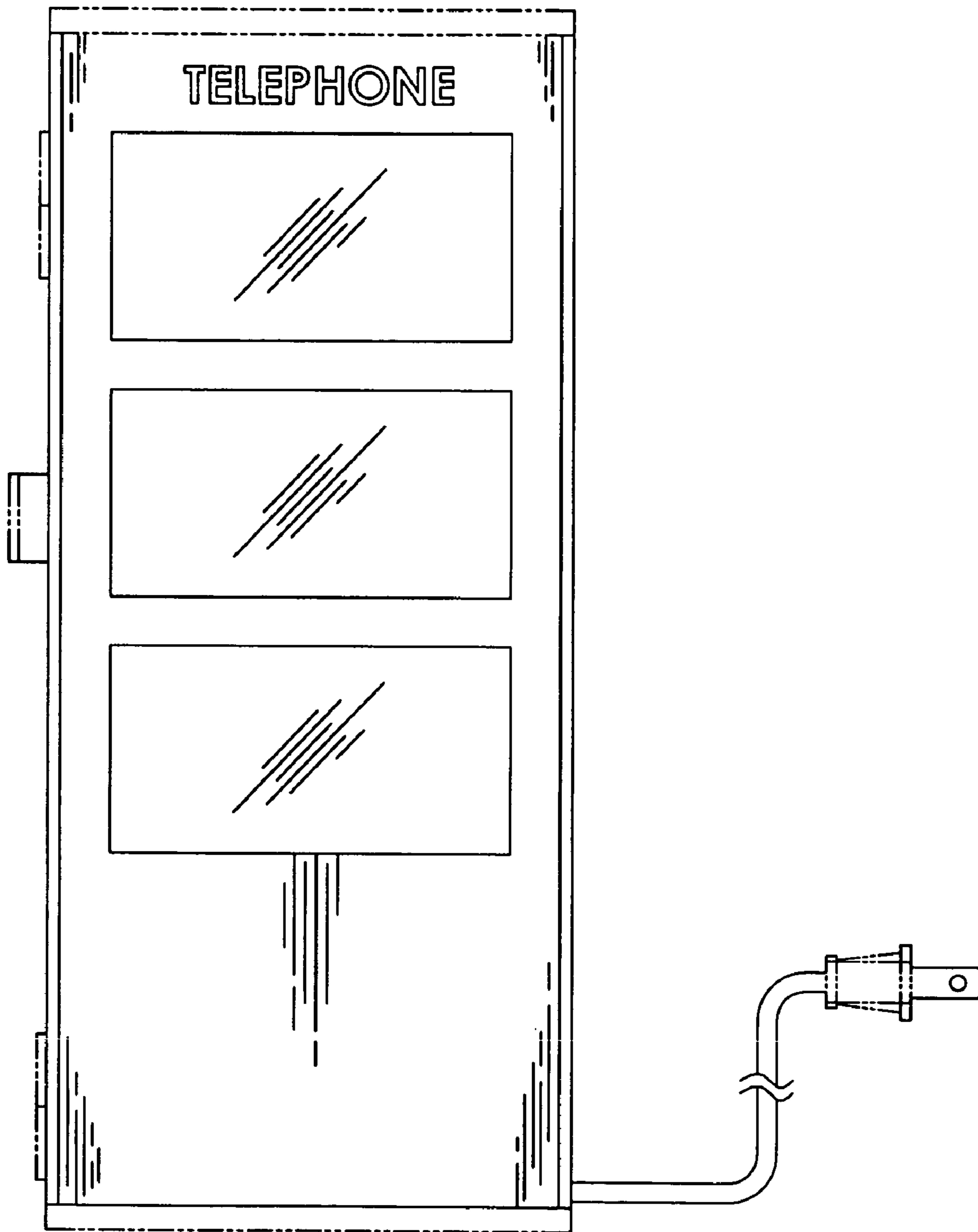

FIG 4

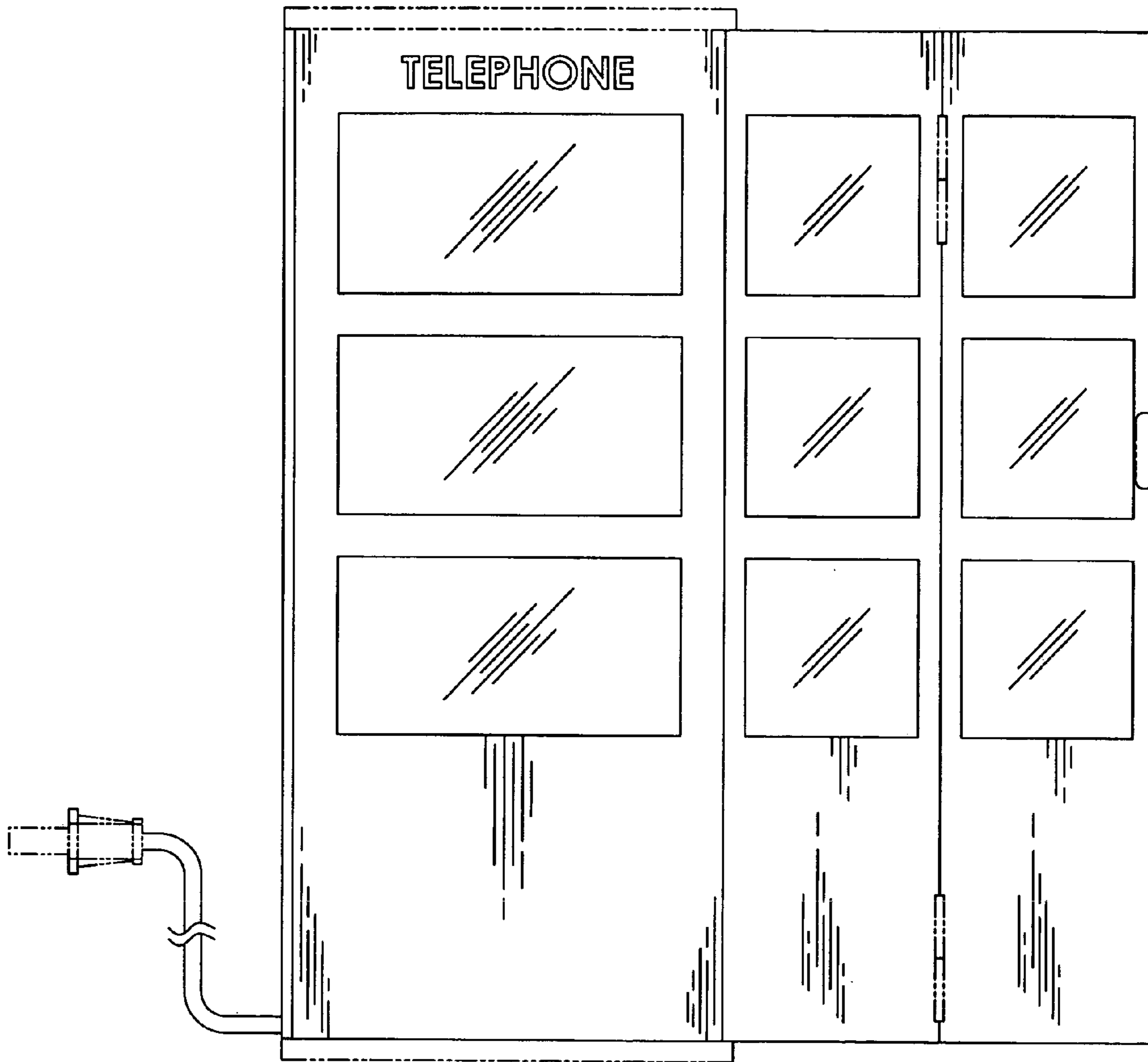

FIG 5

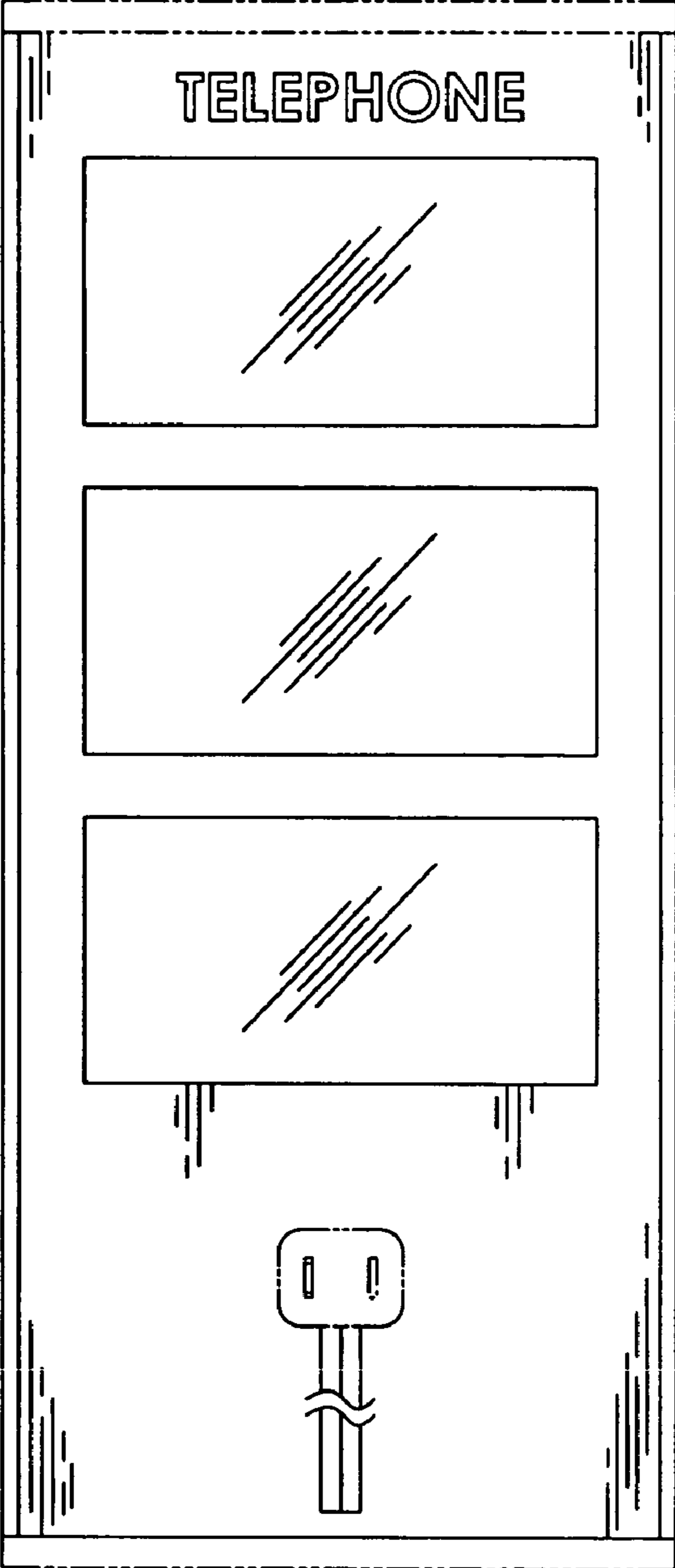

FIG 6

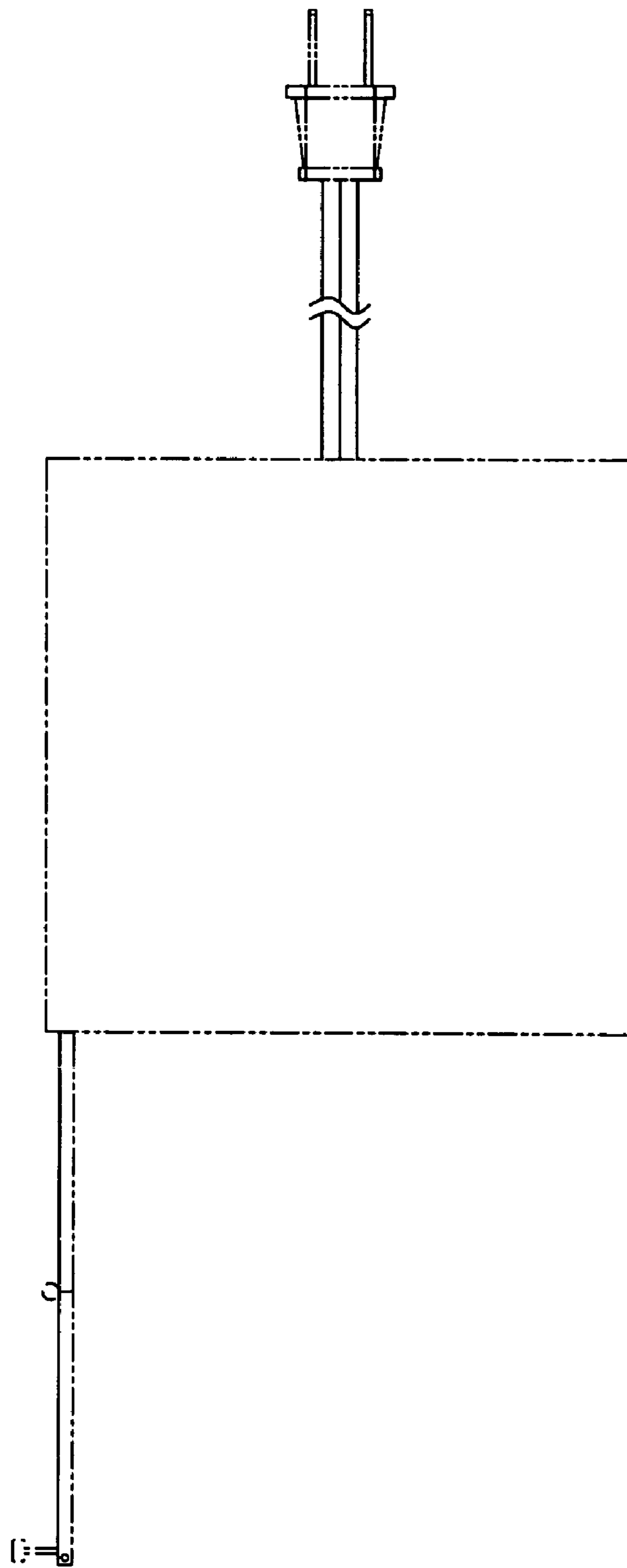

FIG 7

UNITED STATES PATENT AND TRADEMARK OFFICE
CERTIFICATE OF CORRECTION

PATENT NO. : Des. 557,247 S
APPLICATION NO. : 29/253001
DATED : December 11, 2007
INVENTOR(S) : Julie A. Keenan

Page 1 of 8

It is certified that error appears in the above-identified patent and that said Letters Patent is hereby corrected as shown below:

The title page showing the illustrative figure should be deleted to be replaced with the attached title page.

The drawing sheet, consisting of Figs. 1-6, should be deleted to be replaced with the drawing sheet, consisting of Figs. 1-6, as shown on the attached pages.

Signed and Sealed this

Nineteenth Day of January, 2010

A handwritten signature in black ink that reads "David J. Kappos". The signature is written in a cursive, flowing style.

David J. Kappos
Director of the United States Patent and Trademark Office

(12) **United States Design Patent**
Keenan

(10) Patent No.: **US D557,247 S**

(45) Date of Patent: **** Dec. 11, 2007**

(54) **CELL PHONE BOOTH**

(76) Inventor: **Julie A. Keenan**, 6945 Kingsland,
Shelby Township, MI (US) 48317

(**) Term: **14 Years**

(21) Appl. No.: **29/253,001**

(22) Filed: **Jan. 31, 2006**

(51) **LOC (8) Cl.** **14-03**

(52) **U.S. Cl.** **D14/140.2; D14/143; D25/16**

(58) **Field of Classification Search** **D14/138,**
D14/140.2, 143, 299, 496; D25/16; 52/27.5,
52/27. 28

See application file for complete search history.

(56) **References Cited**

U.S. PATENT DOCUMENTS

D192,630 S *	4/1962	Sherron	D25/16
D270,726 S *	9/1983	Weiss	D14/143
D337,831 S *	7/1993	McNamara et al.	D25/16
D361,334 S	8/1995	Chan		
D367,065 S	2/1996	Wu		
D370,681 S	6/1996	Diamond		
D381,664 S	7/1997	Williams et al.		
D412,209 S *	7/1999	Hunt	D25/16
D416,914 S	11/1999	Lummis		
D432,661 S *	10/2000	Caya	D25/16
D439,577 S *	3/2001	Smith	D14/140.2

OTHER PUBLICATIONS

British Telephone Booth; author unknown; date unknown.
American Telephone Booth; author unknown; date unknown.

* cited by examiner

Primary Examiner—Terry A Wallace

(74) *Attorney, Agent, or Firm*—Harness, Dickey & Pierce,
PLC

(57) **CLAIM**

The ornamental design for a cell phone booth, as shown and described.

DESCRIPTION

FIG. 1 is a perspective view of a cell phone booth in accordance with the present teachings;

FIG. 2 is similar to FIG. 1 and shows a door of the cell phone booth open;

FIG. 3 is a front view of the cell phone booth of FIG. 1;

FIG. 4 is a side view of the cell phone booth of FIG. 1;

FIG. 5 is a side view of the cell phone booth of FIG. 1 and shows the door open;

FIG. 6 is a rear view of the cell phone booth; and,

FIG. 7 is a top view of the cell phone booth with the door open, a bottom view is excluded as the bottom is flat and devoid of surface ornamentation.

The broken lines are for illustrative purposes only and form no part of the claimed design. The "TELEPHONE" text being shown with broken lines is for illustrative purposes only and forms no part of the claimed design.

1 Claim, 7 Drawing Sheets

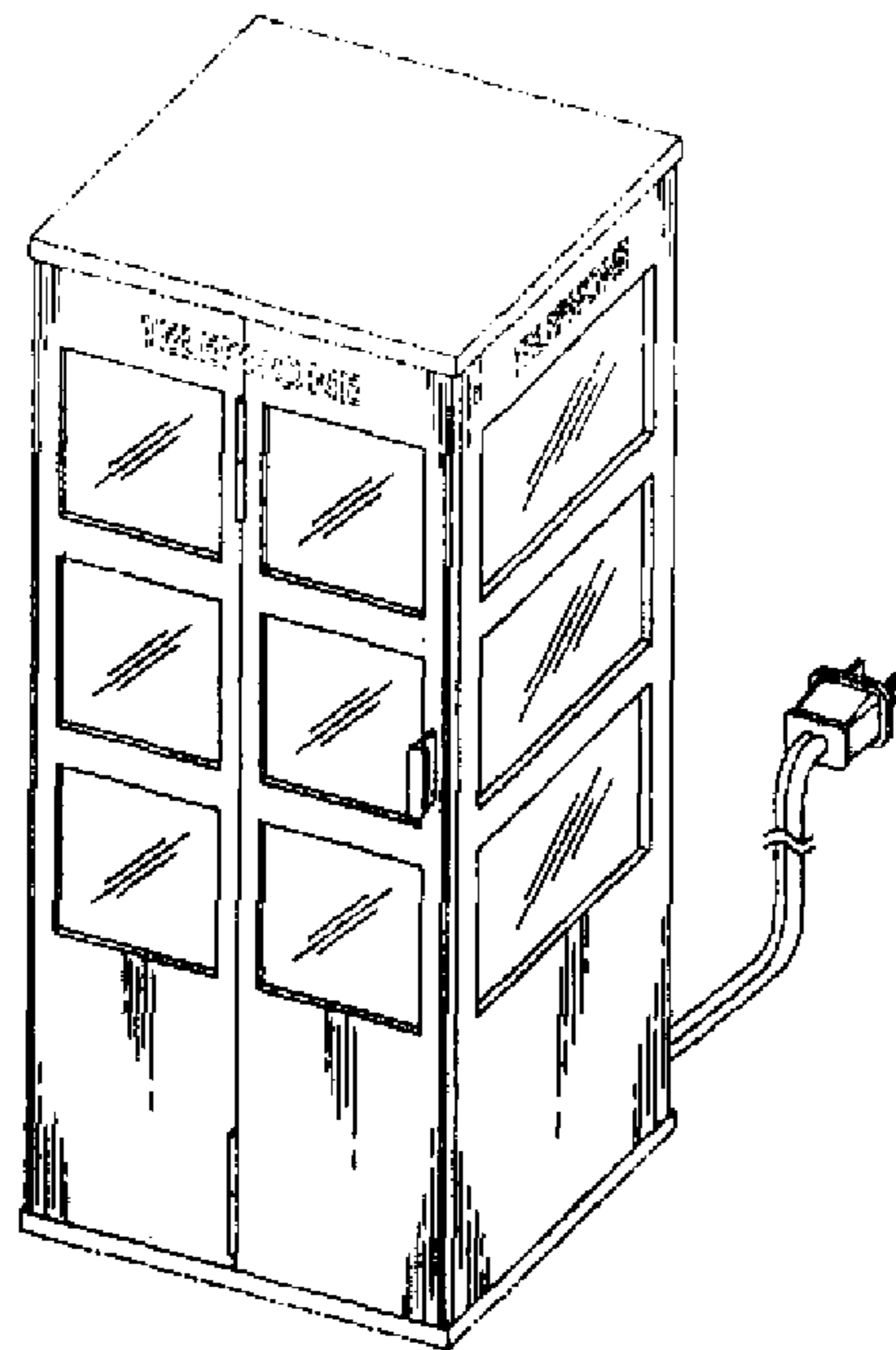

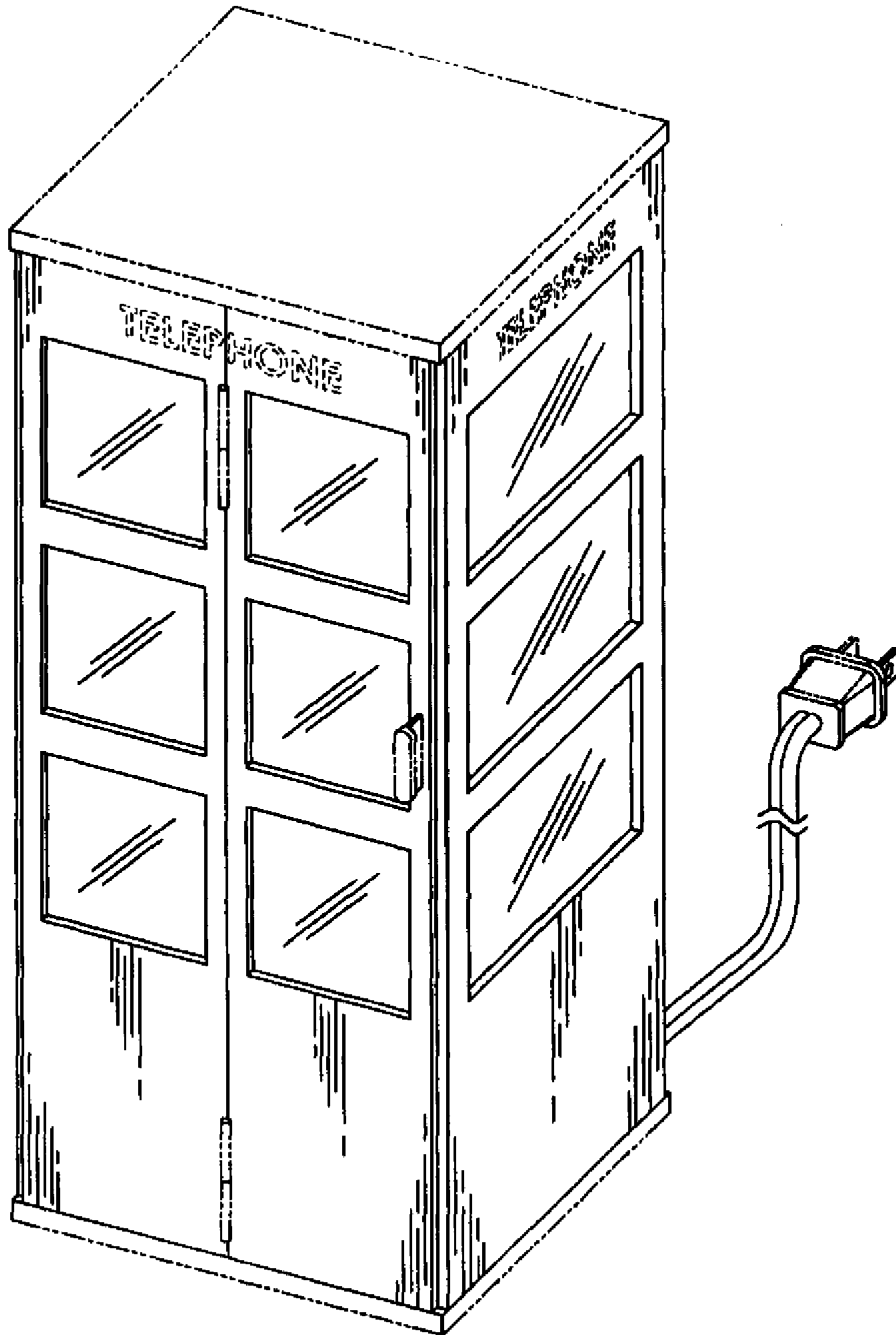

FIG 1

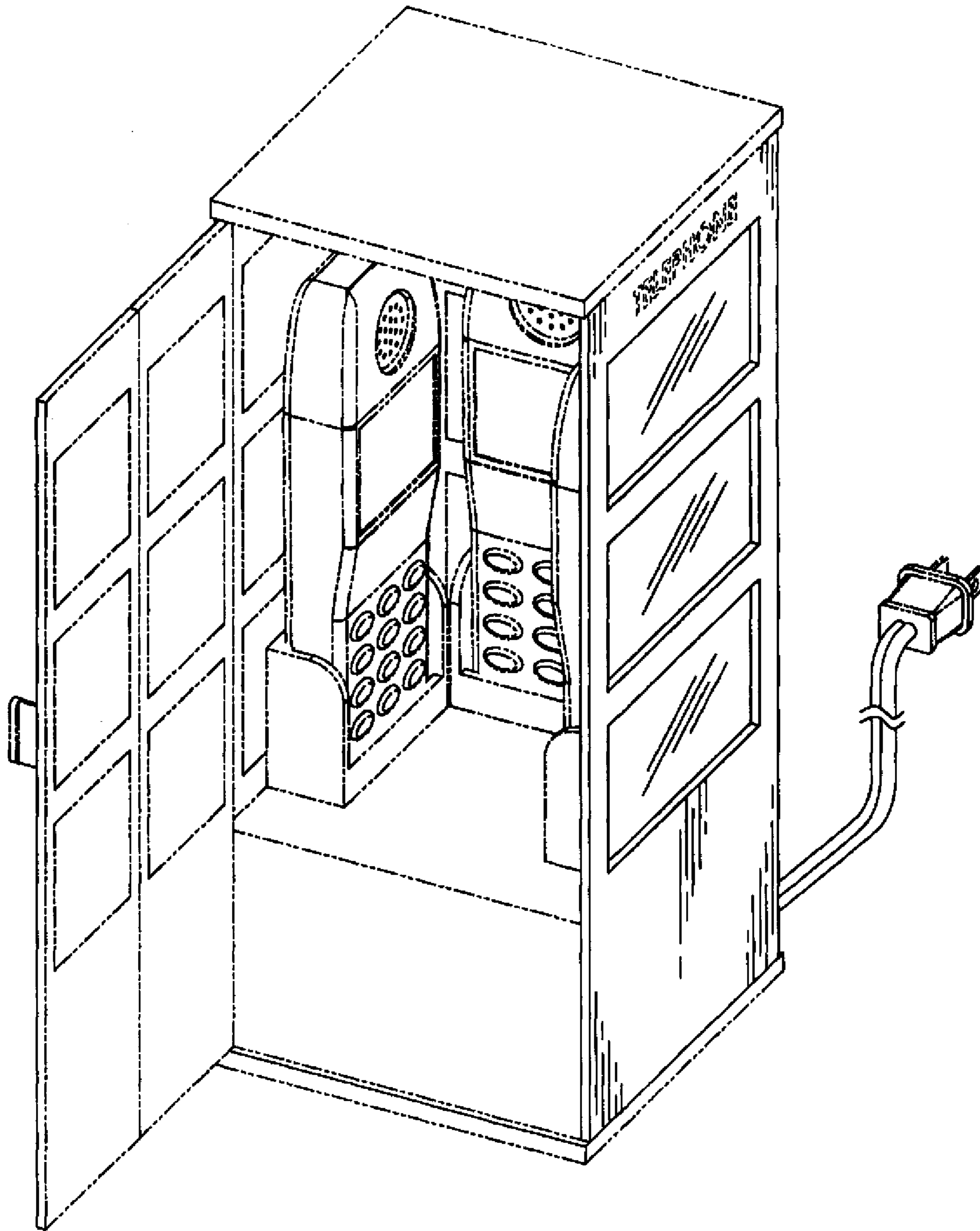

FIG 2

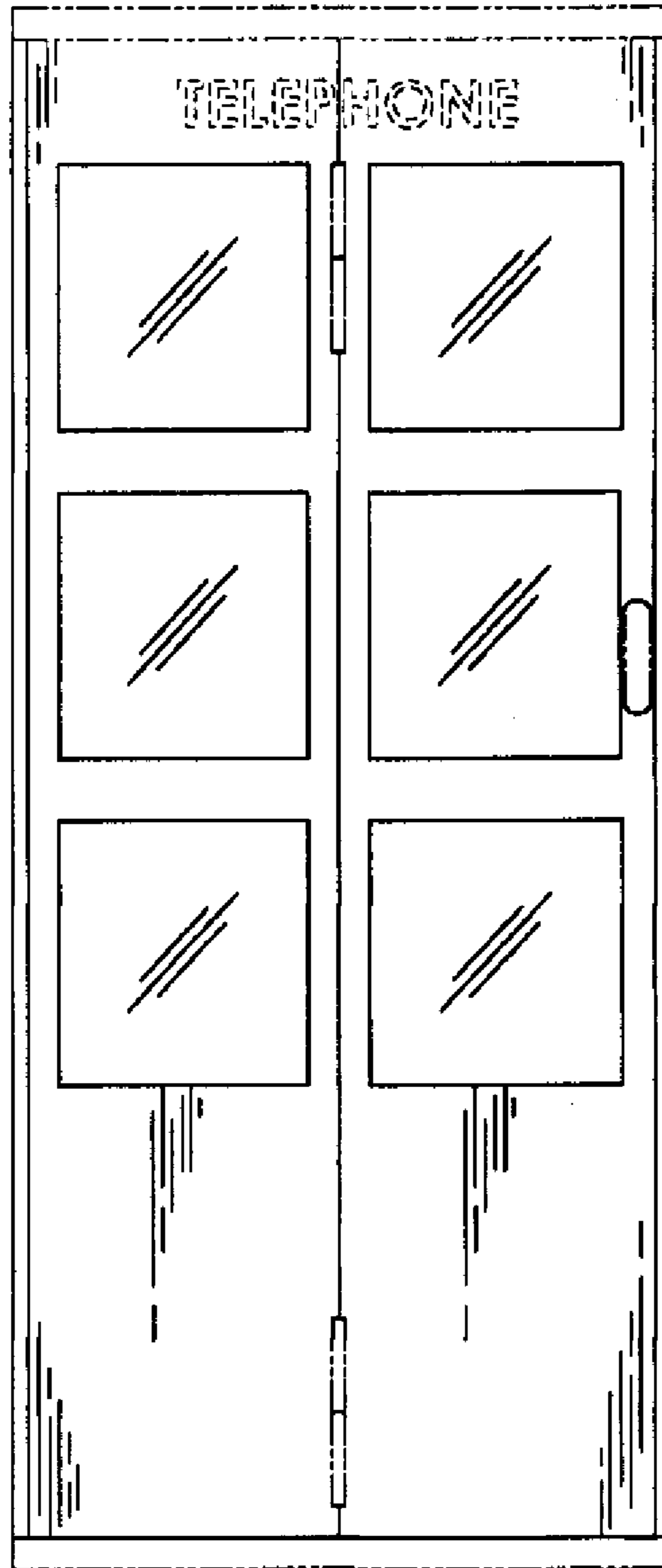

FIG 3

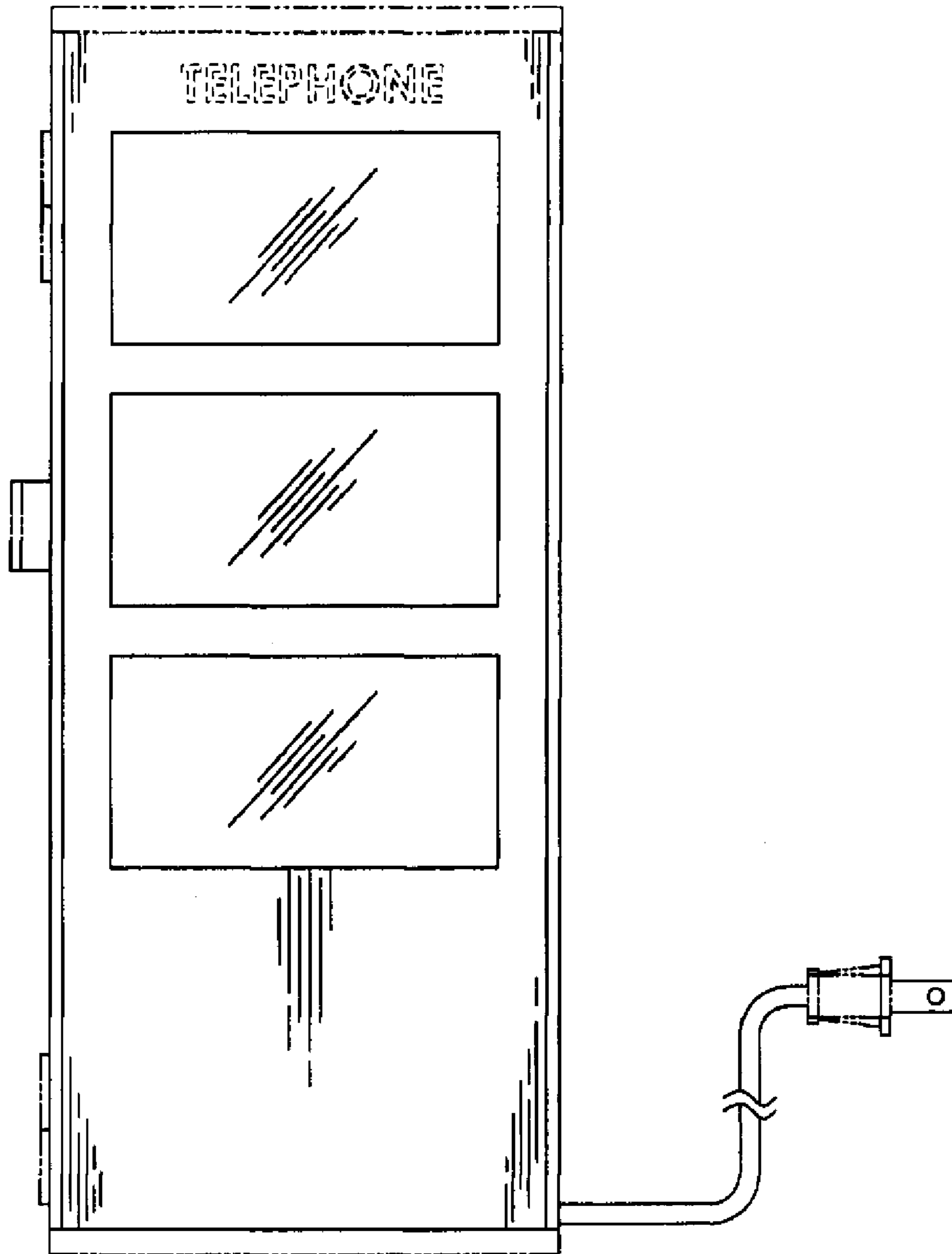

FIG 4

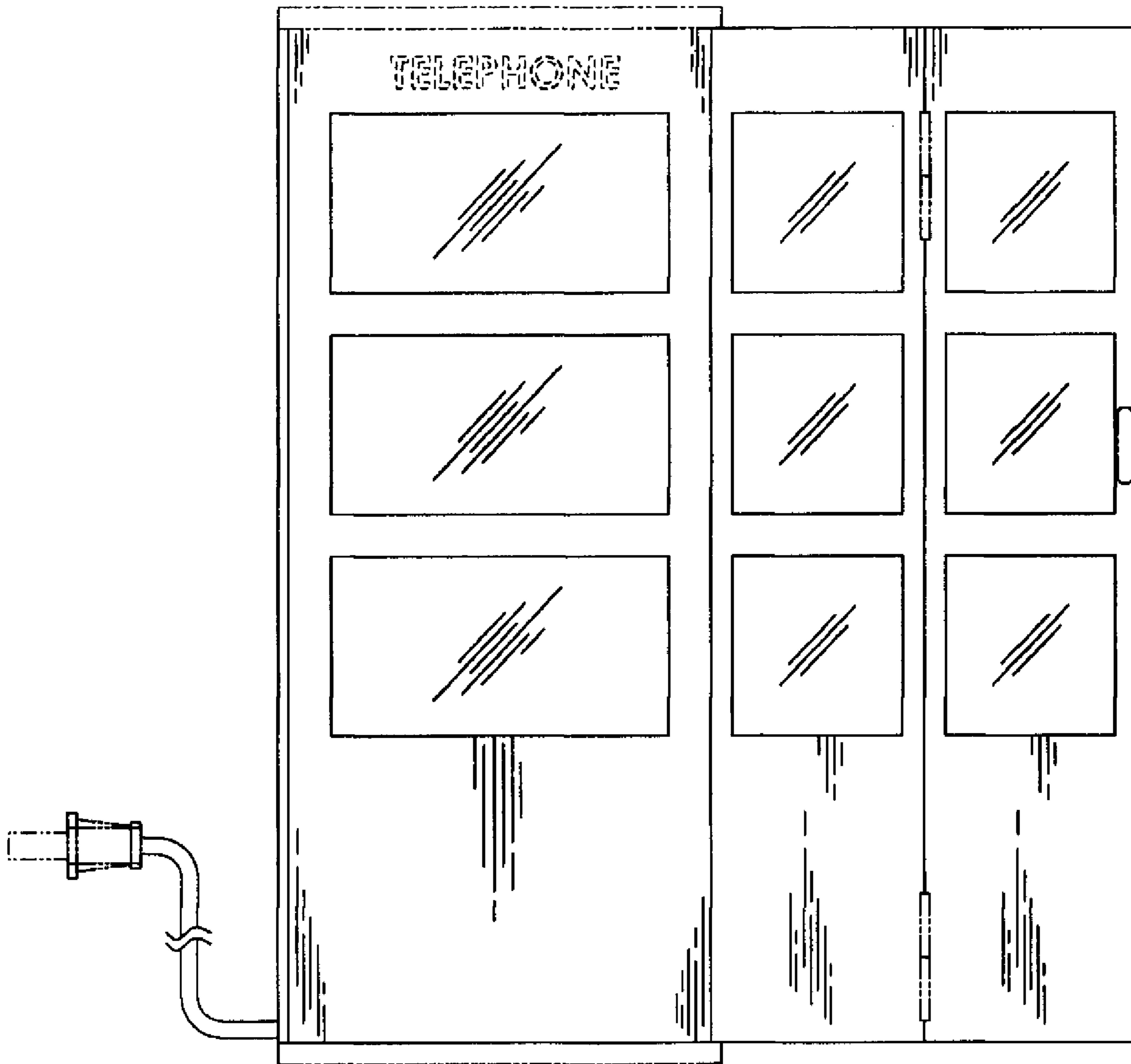

FIG 5

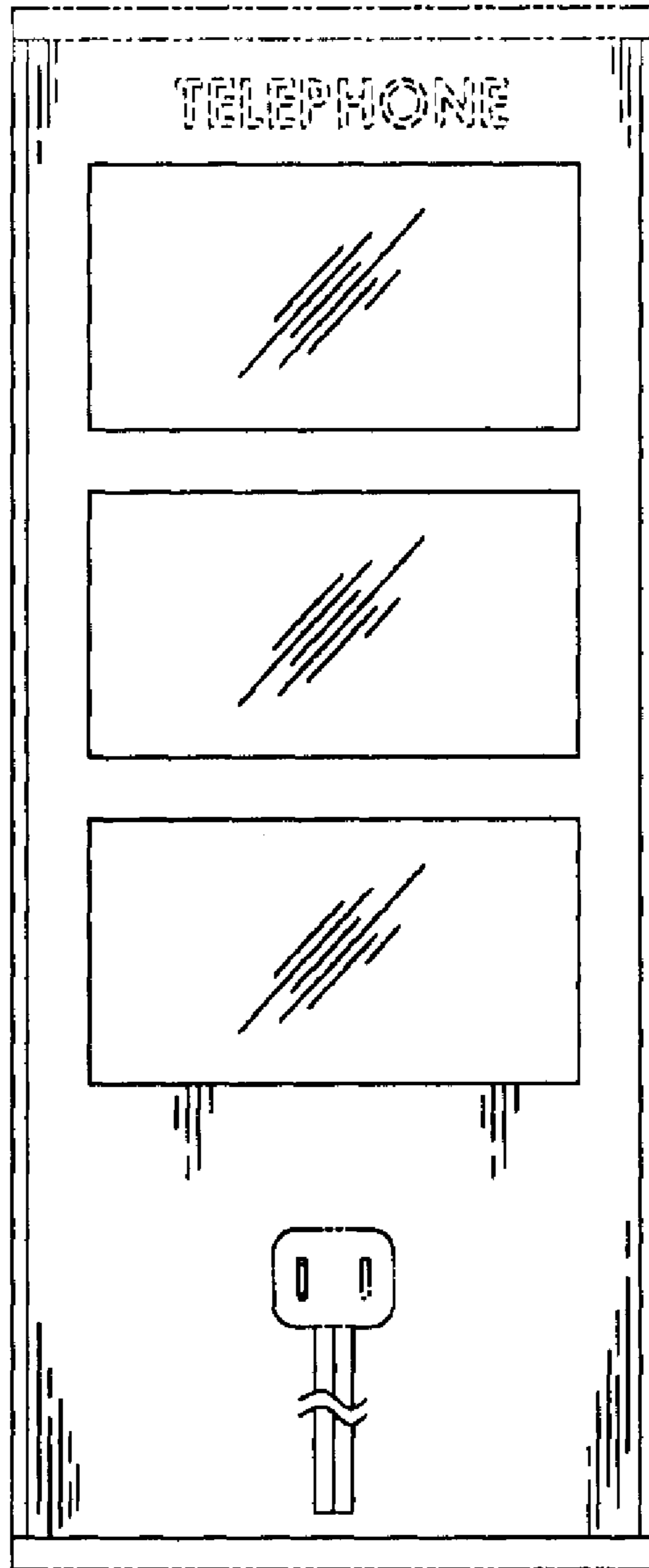

FIG 6