



US00D557166S

(12) **United States Design Patent**
Wysopal

(10) **Patent No.:** **US D557,166 S**

(45) **Date of Patent:** **** Dec. 11, 2007**

(54) **BRACELET BOTTLE OPENER**

(76) Inventor: **James Wysopal**, 2239 Aralia St.,
Newport Beach, CA (US) 92660

(**) Term: **14 Years**

(21) Appl. No.: **29/264,819**

(22) Filed: **Aug. 18, 2006**

(51) **LOC (8) Cl.** **11-01**

(52) **U.S. Cl.** **D11/26**

(58) **Field of Classification Search** D11/3,
D11/4, 26-30, 89-92; 63/3, 5.7-15.8, 15.9,
63/26-28; 606/204; D8/18, 33, 34, 38,
D8/40; D9/448; 224/175; D10/30, 38,
D10/46.1; 7/152

See application file for complete search history.

(56) **References Cited**

U.S. PATENT DOCUMENTS

D347,152 S *	5/1994	Mohawk et al.	D8/40
D408,237 S *	4/1999	Wysopal	D8/38
D421,372 S *	3/2000	Wysopal	D8/38
D433,298 S *	11/2000	Wysopal	D8/38
D443,804 S *	6/2001	Wysopal	D8/38
D466,381 S *	12/2002	Joseph	D8/18

D473,118 S *	4/2003	Lovegrove	D8/40
7,143,666 B1 *	12/2006	Gutierrez	D8/40
D540,130 S *	4/2007	Wysopal	D8/34

* cited by examiner

Primary Examiner—Ian Simmons

Assistant Examiner—Michael A. Pratt

(74) *Attorney, Agent, or Firm*—Eric Karich

(57) **CLAIM**

The ornamental design for a “bracelet bottle opener,” as shown and described.

DESCRIPTION

FIG. 1 is a perspective view of a bracelet bottle opener, showing my new design;

FIG. 2 is a bottom plan view thereof;

FIG. 3 is a top plan view thereof;

FIG. 4 is a left side elevational view thereof;

FIG. 5 is a right side elevational view thereof;

FIG. 6 is a front plan view thereof; and,

FIG. 7 is a rear plan view thereof.

1 Claim, 3 Drawing Sheets

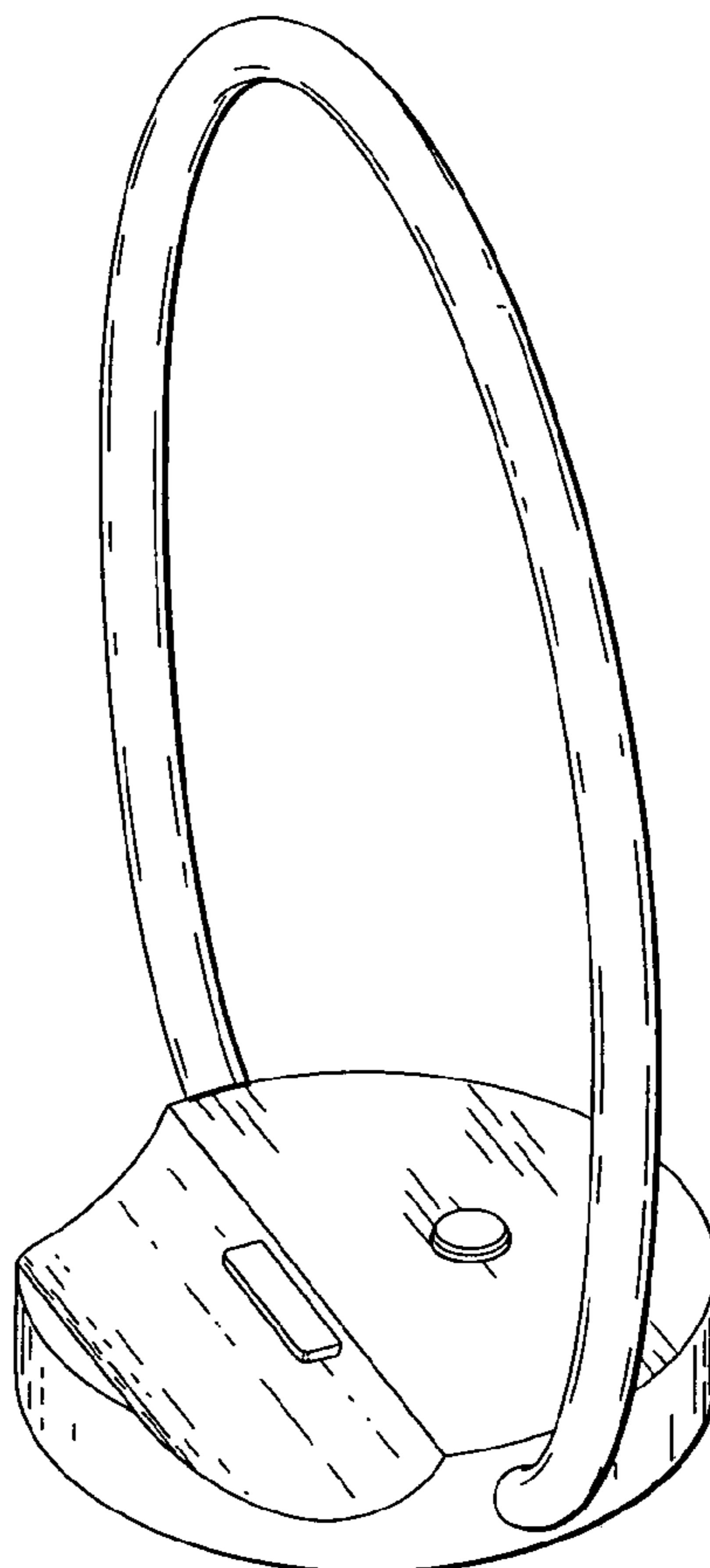

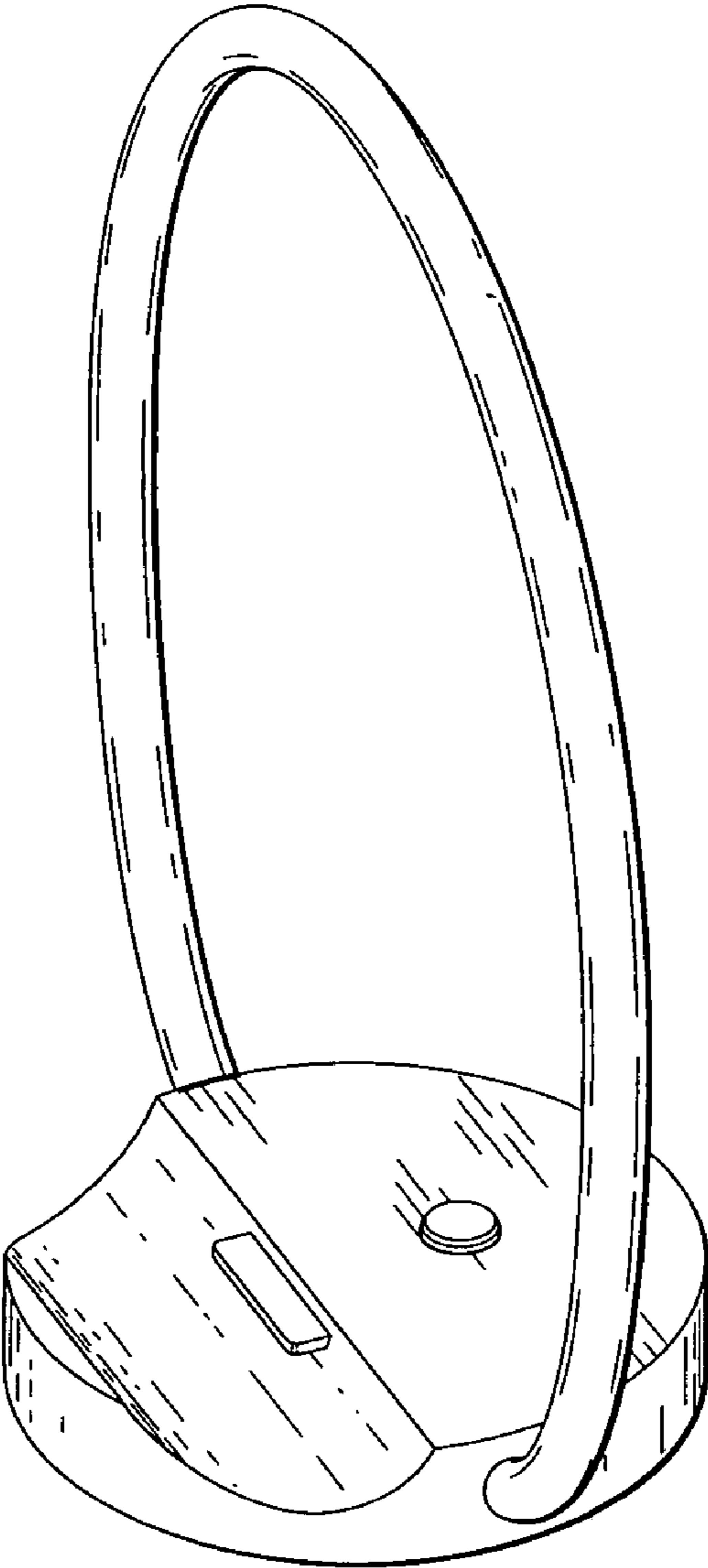

Fig. 1

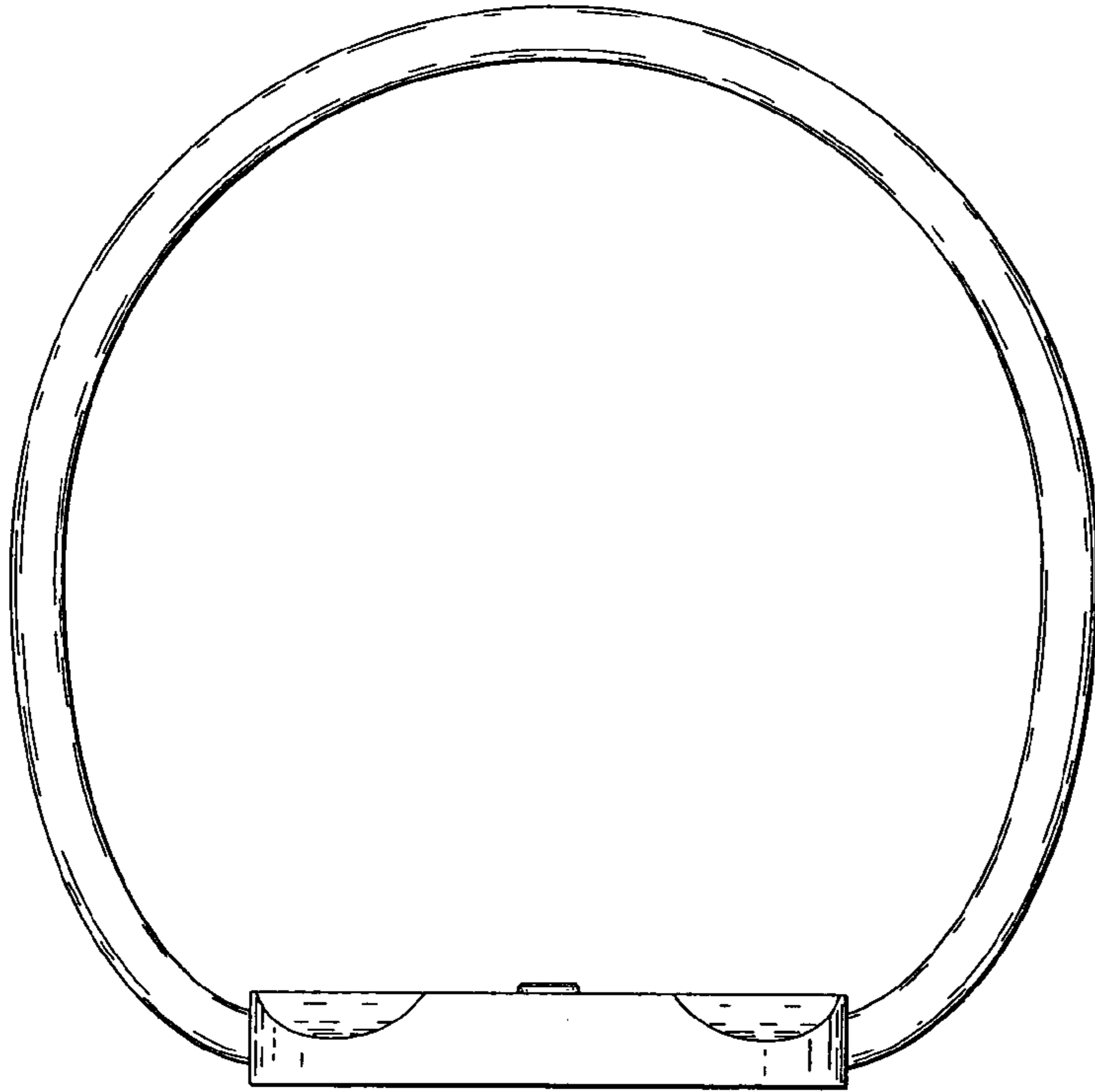

Fig. 2

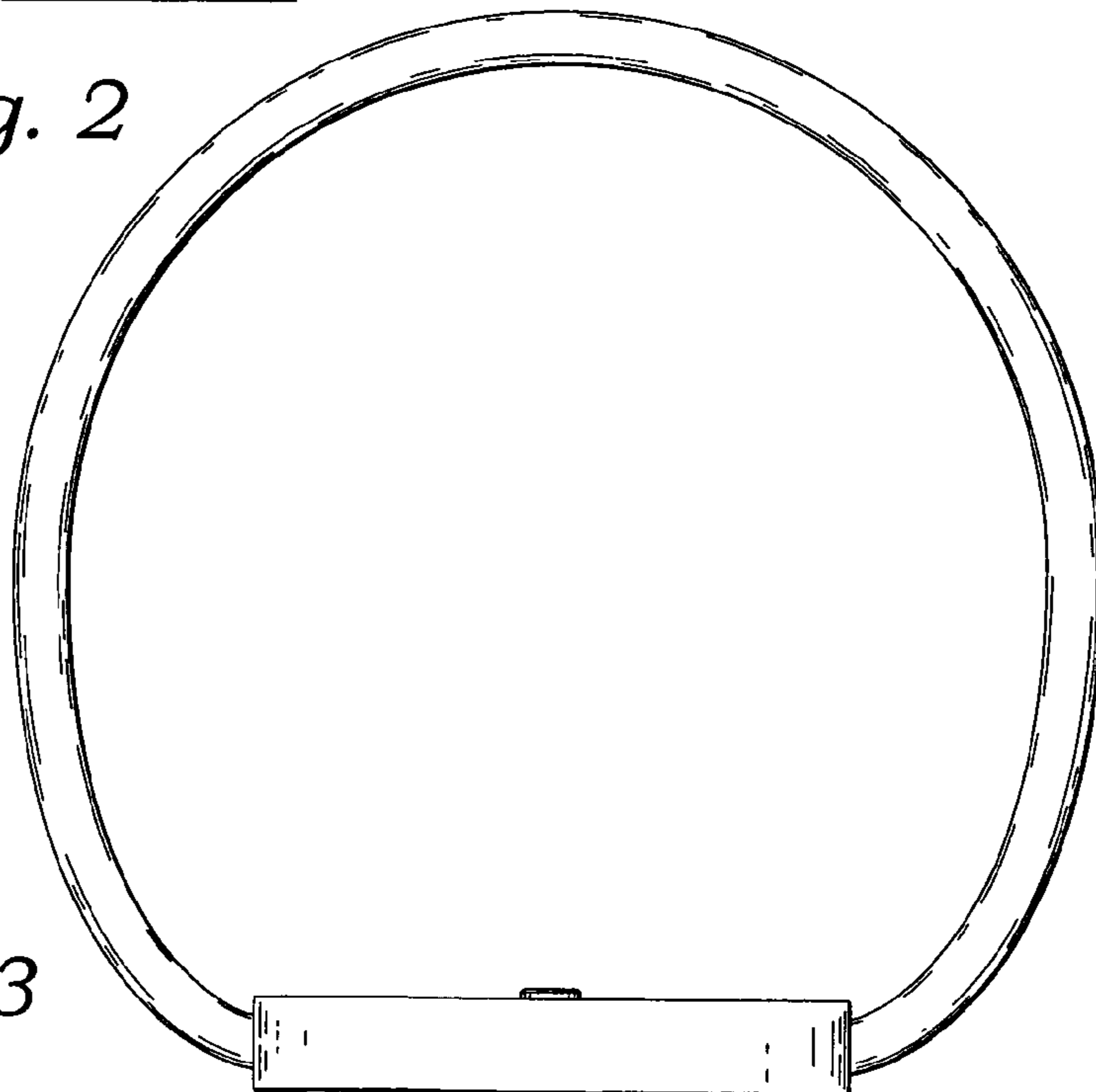

Fig. 3

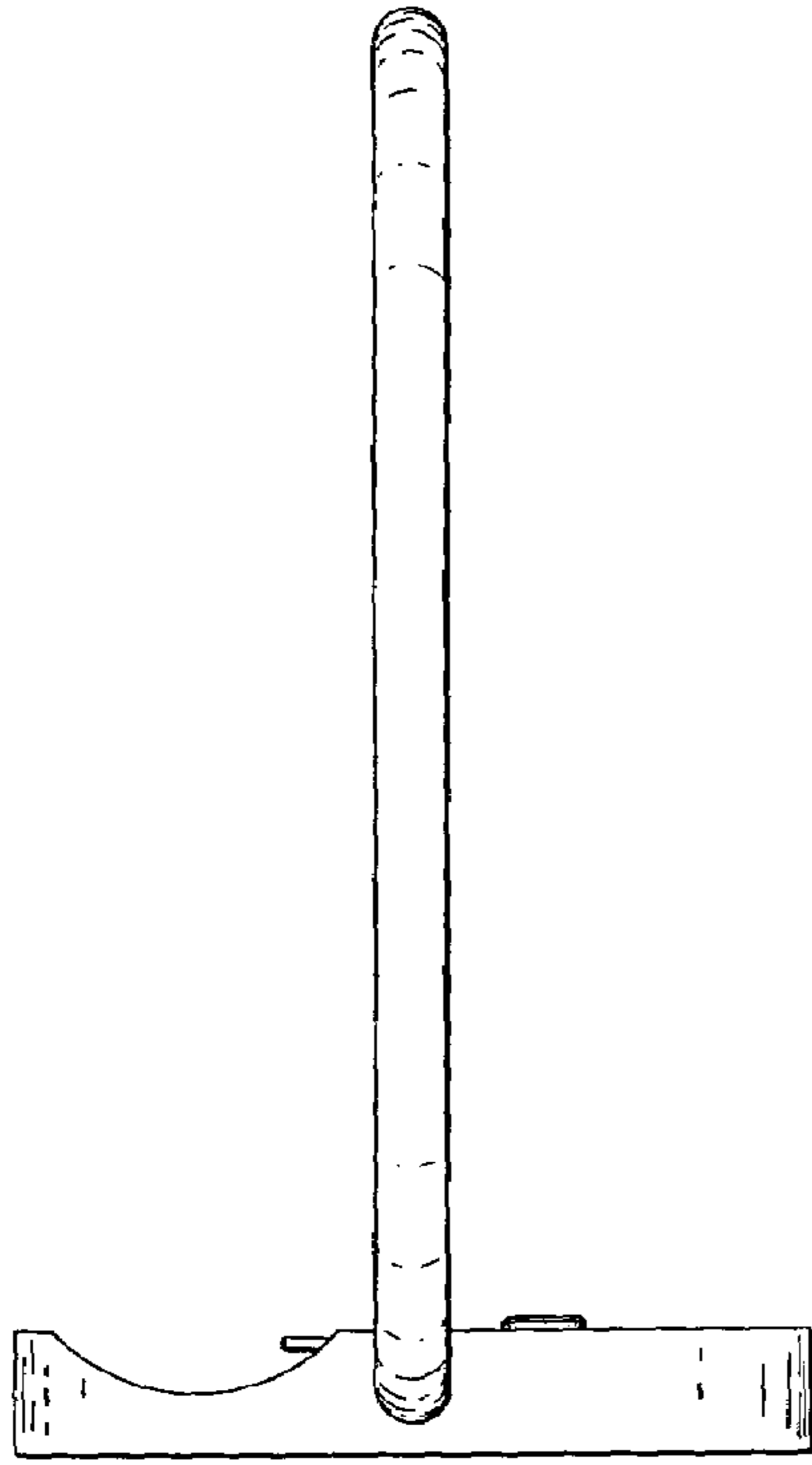

Fig. 4

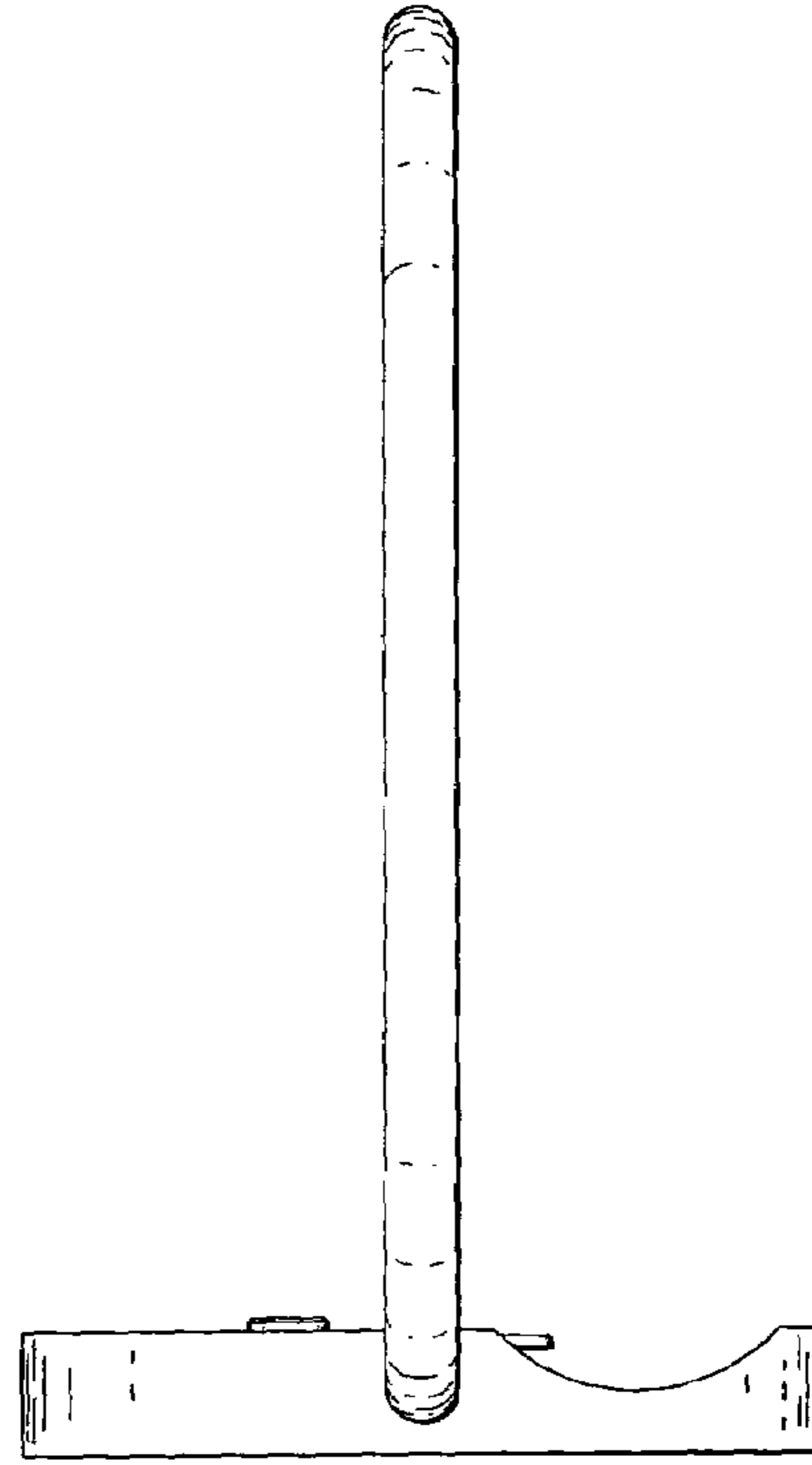

Fig. 5

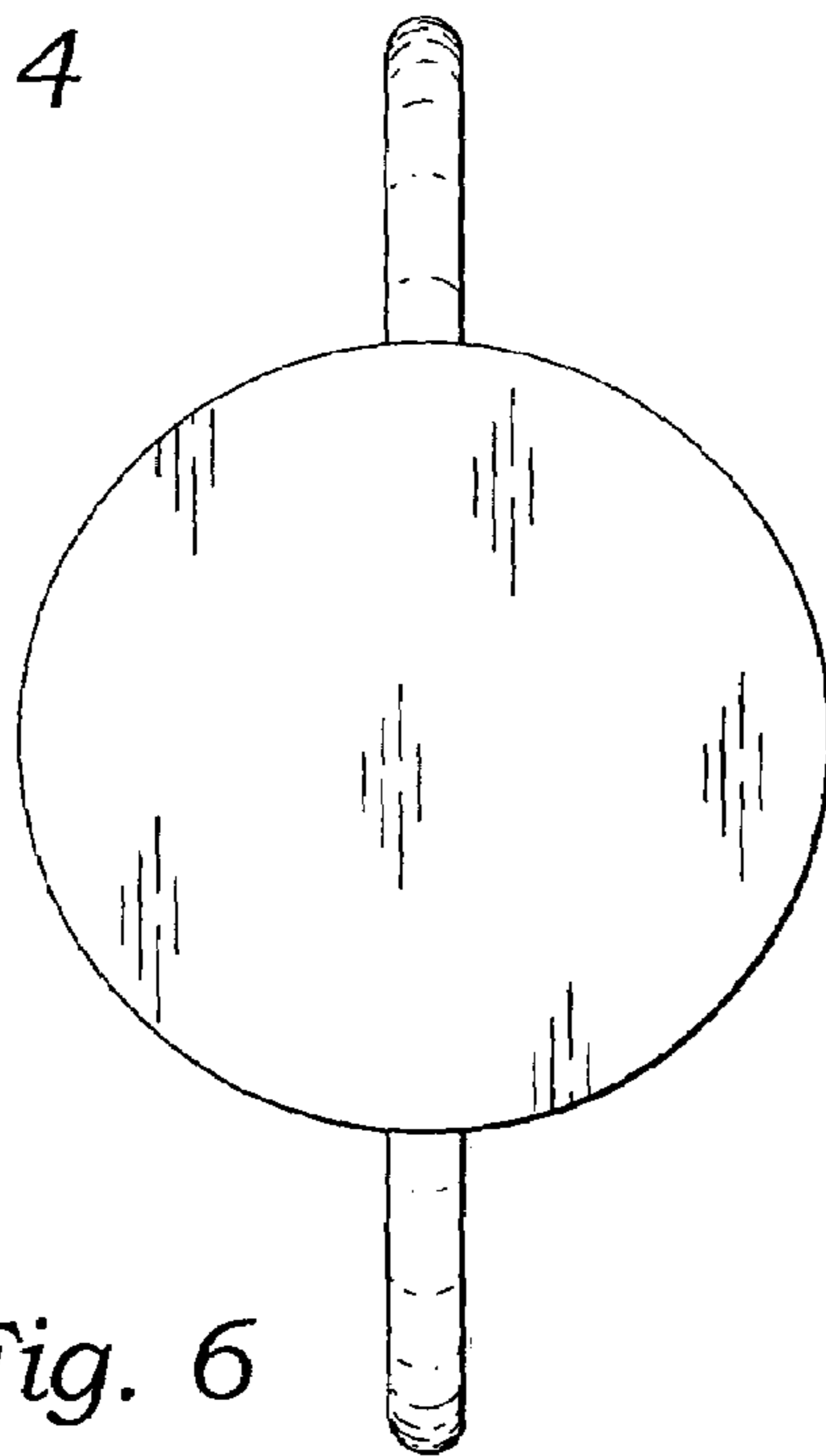

Fig. 6

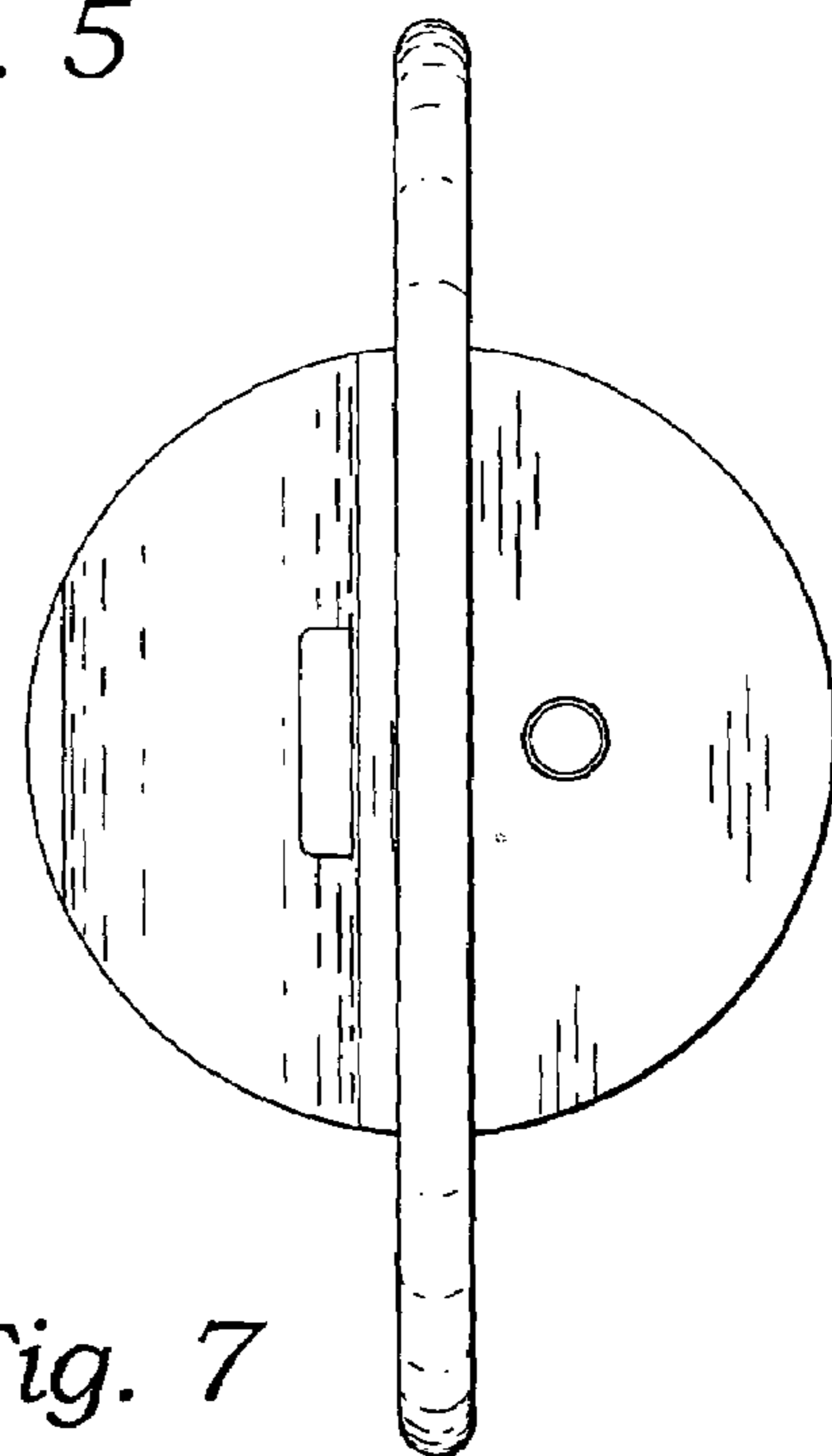

Fig. 7