



US00D557109S

(12) **United States Design Patent** (10) **Patent No.:** **US D557,109 S**
Navin (45) **Date of Patent:** **** Dec. 11, 2007**

(54) **AUTOMOTIVE HOOD LATCH SECURITY SHIELD**

Primary Examiner—Mitchell Siegel
(74) *Attorney, Agent, or Firm*—Timothy M. Barlow

(76) Inventor: **Jeffery P. Navin**, 11011 S. 48th St., Suite 103, Phoenix, AZ (US) 85044

(57) **CLAIM**

The ornamental design for an automotive hood latch security shield, as shown.

(**) Term: **14 Years**

(21) Appl. No.: **29/262,078**

DESCRIPTION

(22) Filed: **Jun. 26, 2006**

FIG. 1 is a perspective view of an automotive hood latch security shield according to the present invention.

(51) **LOC (8) Cl.** **08-07**

FIG. 2 is a perspective view of an automotive hood latch security shield according to the present invention.

(52) **U.S. Cl.** **D8/346**

FIG. 3 is a front view of an automotive hood latch security shield according to the present invention.

(58) **Field of Classification Search** D8/330–348;
D25/102, 119–125; 292/DIG. 14, DIG. 64,
292/346, 216, 341.17, 337, 123; 70/240,
70/341, 370, 417

FIG. 4 is a top view of an automotive hood latch security shield according to the present invention.

See application file for complete search history.

FIG. 5 is a rear view of an automotive hood latch security shield according to the present invention.

(56) **References Cited**

U.S. PATENT DOCUMENTS

3,199,322	A *	8/1965	Braun et al.	70/240
5,172,946	A *	12/1992	Dowling	292/216
5,618,069	A *	4/1997	Konchan et al.	292/216
6,014,876	A *	1/2000	Taylor	70/240
D465,720	S *	11/2002	Persson	D8/331
2006/0082165	A1 *	4/2006	Rose	292/337

FIG. 6 is a bottom view of an automotive hood latch security shield according to the present invention.

FIG. 7 is a side view of an automotive hood latch security shield according to the present invention; and,

FIG. 8 is a side view of an automotive hood latch security shield according to the present invention.

* cited by examiner

1 Claim, 4 Drawing Sheets

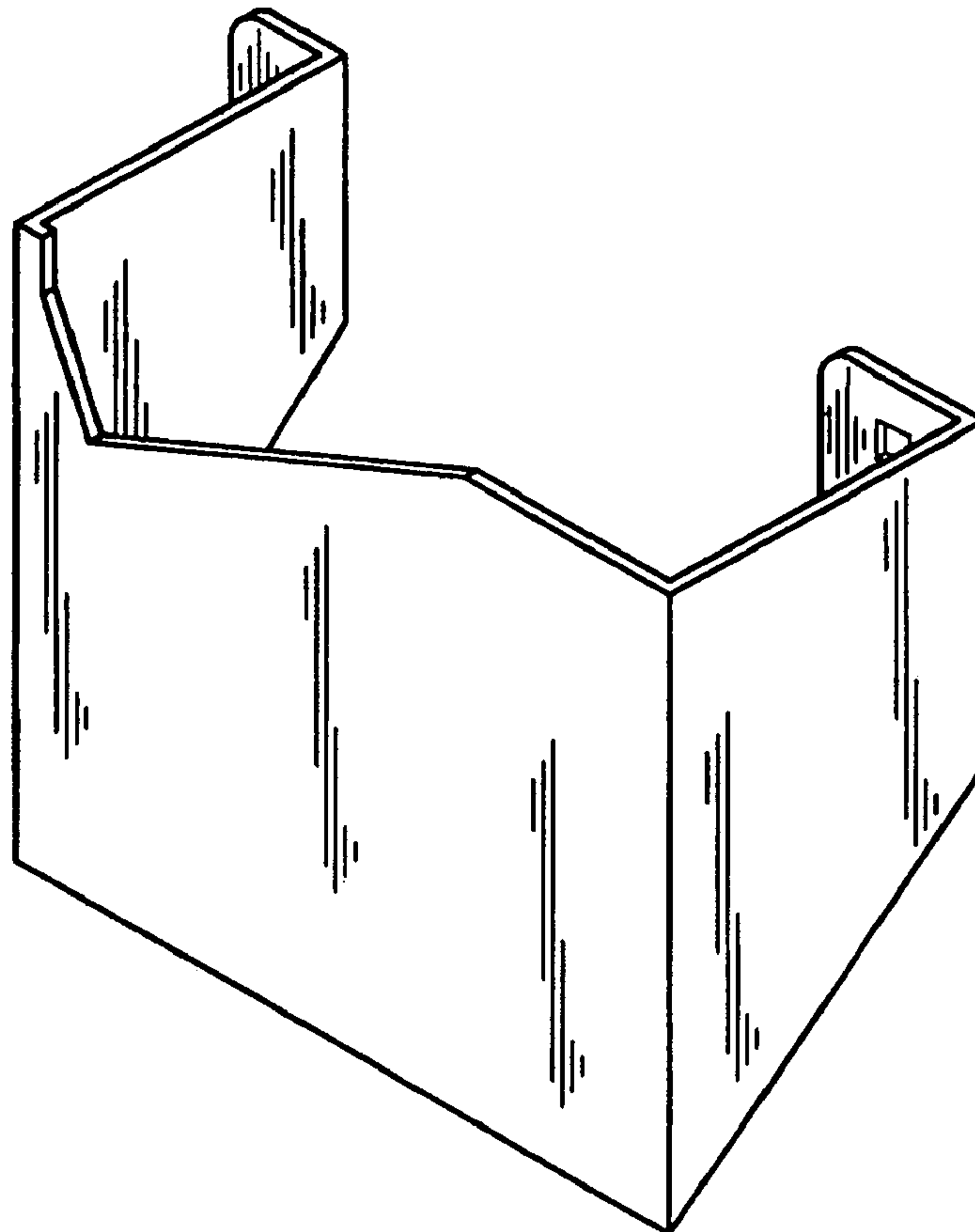

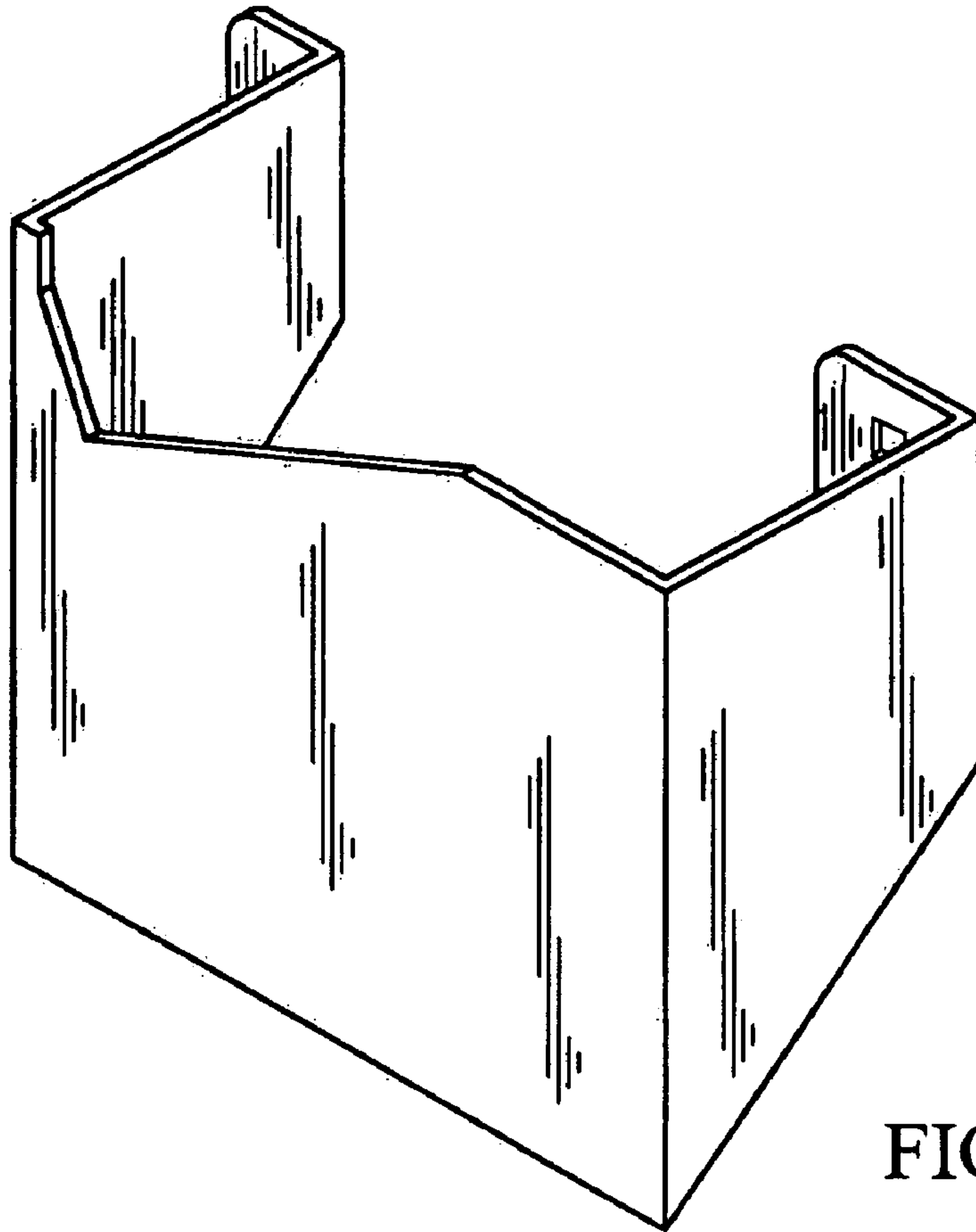

FIG. 1

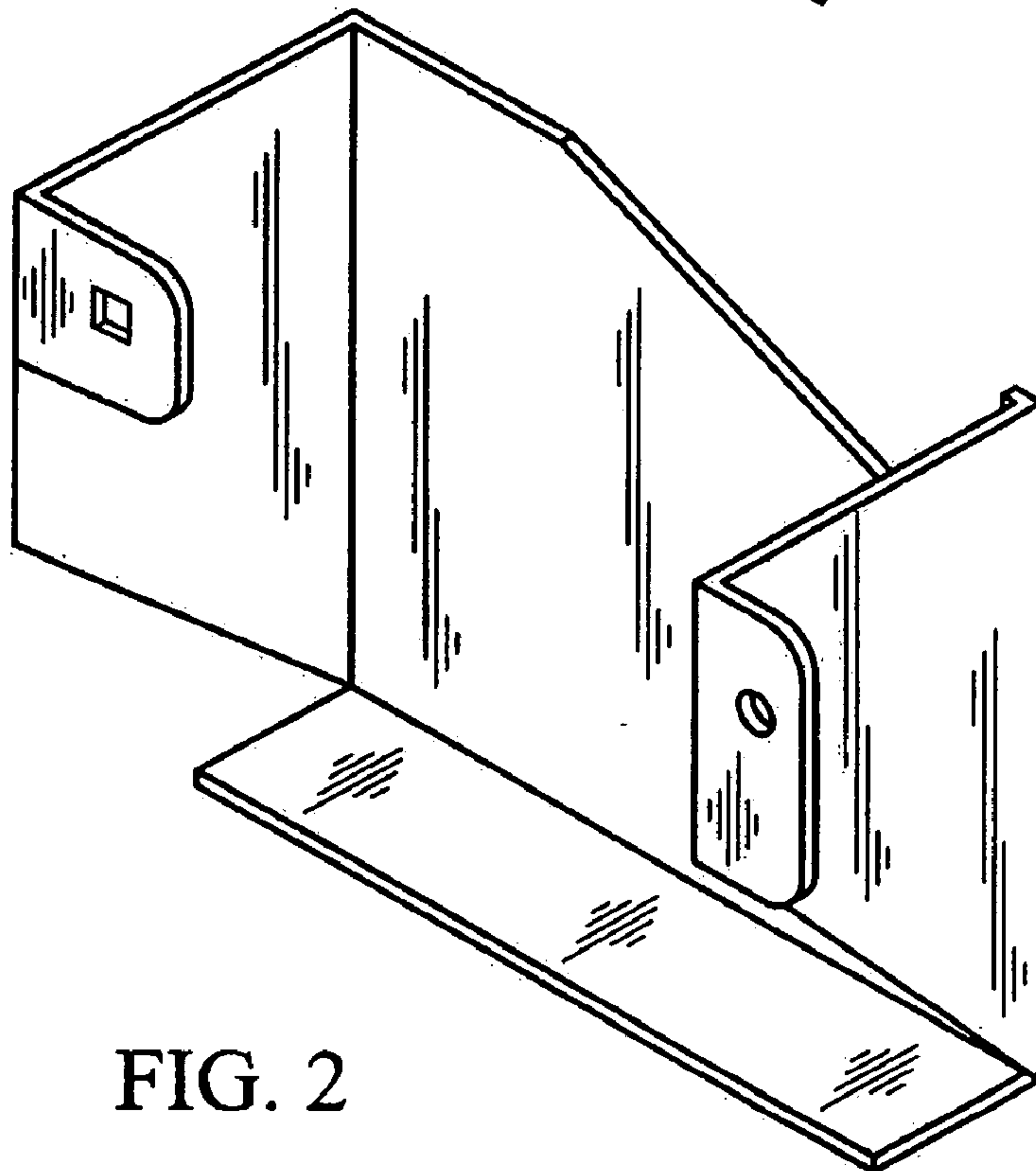

FIG. 2

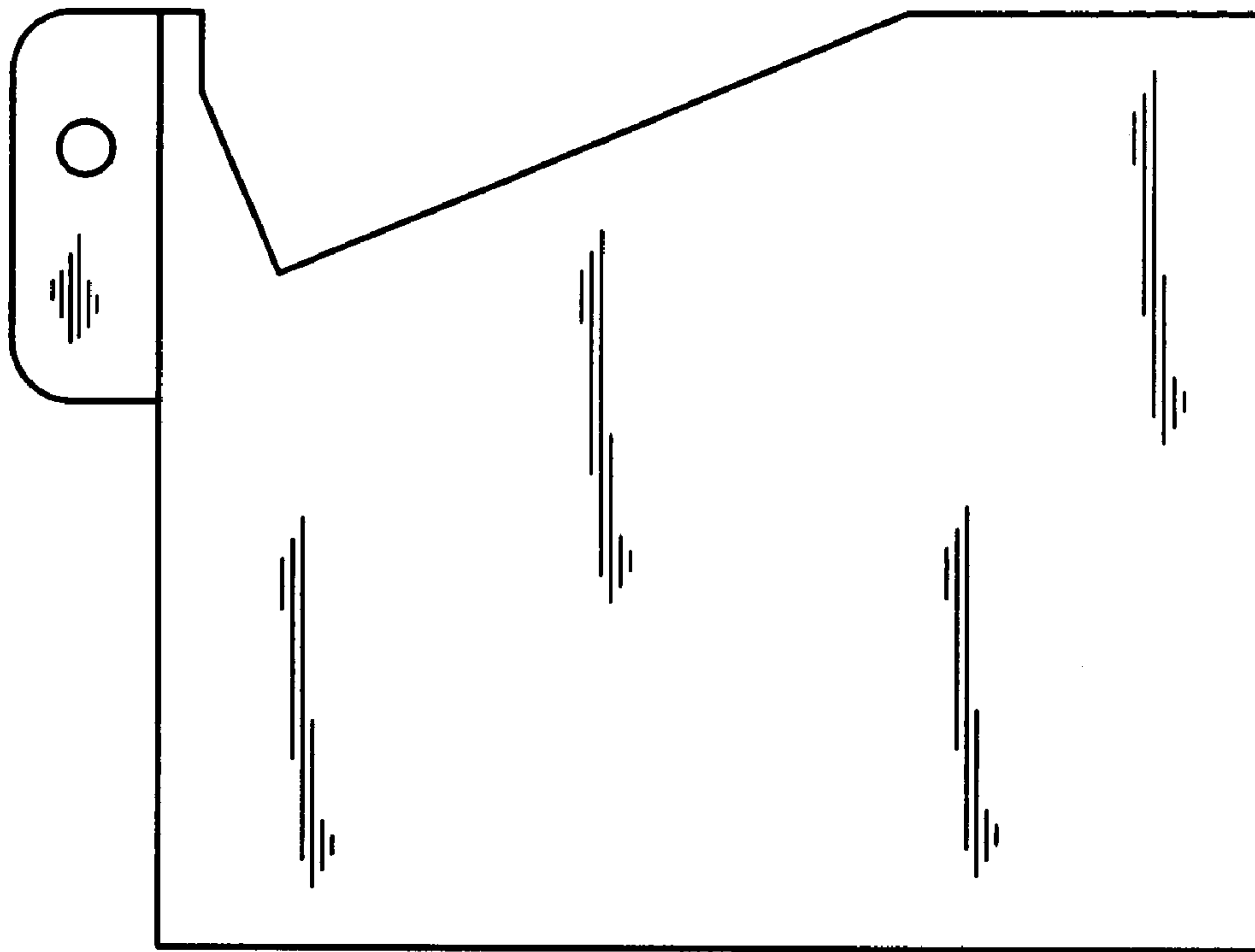

FIG. 3

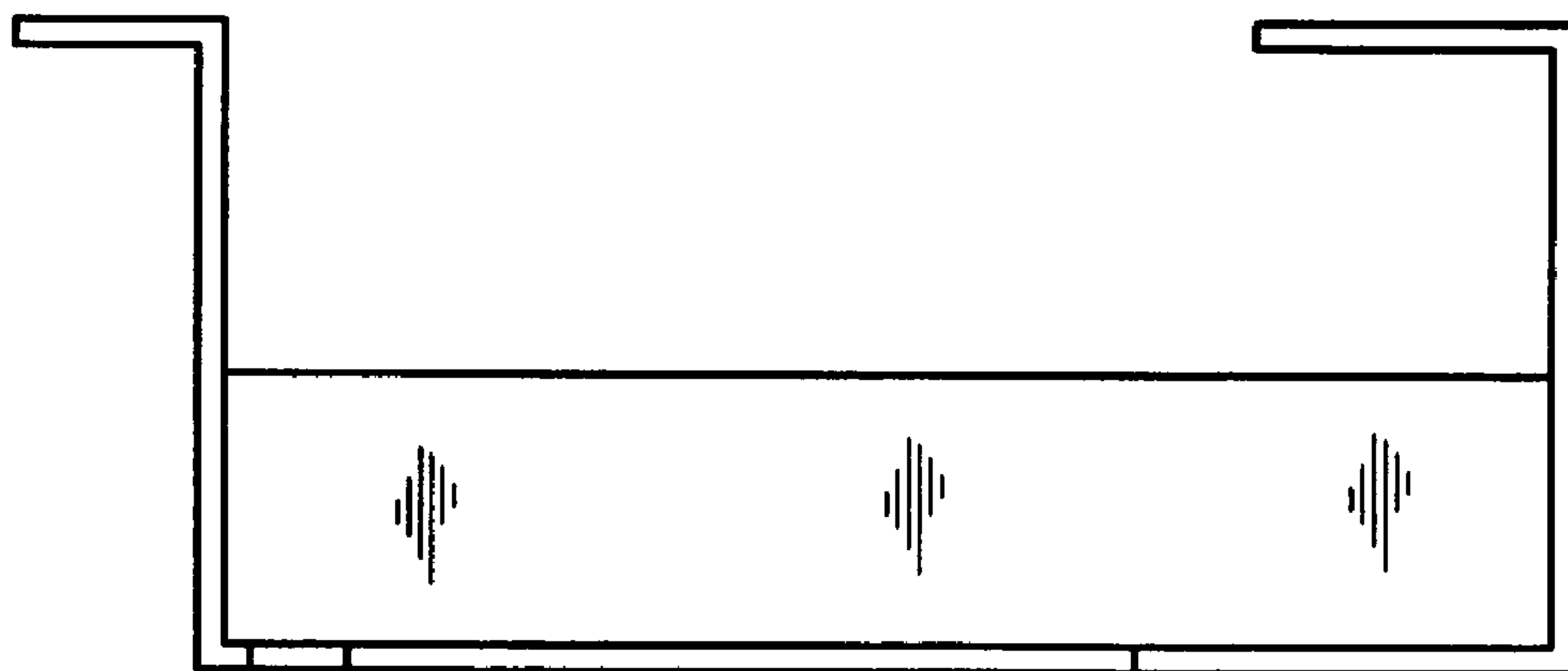

FIG. 4

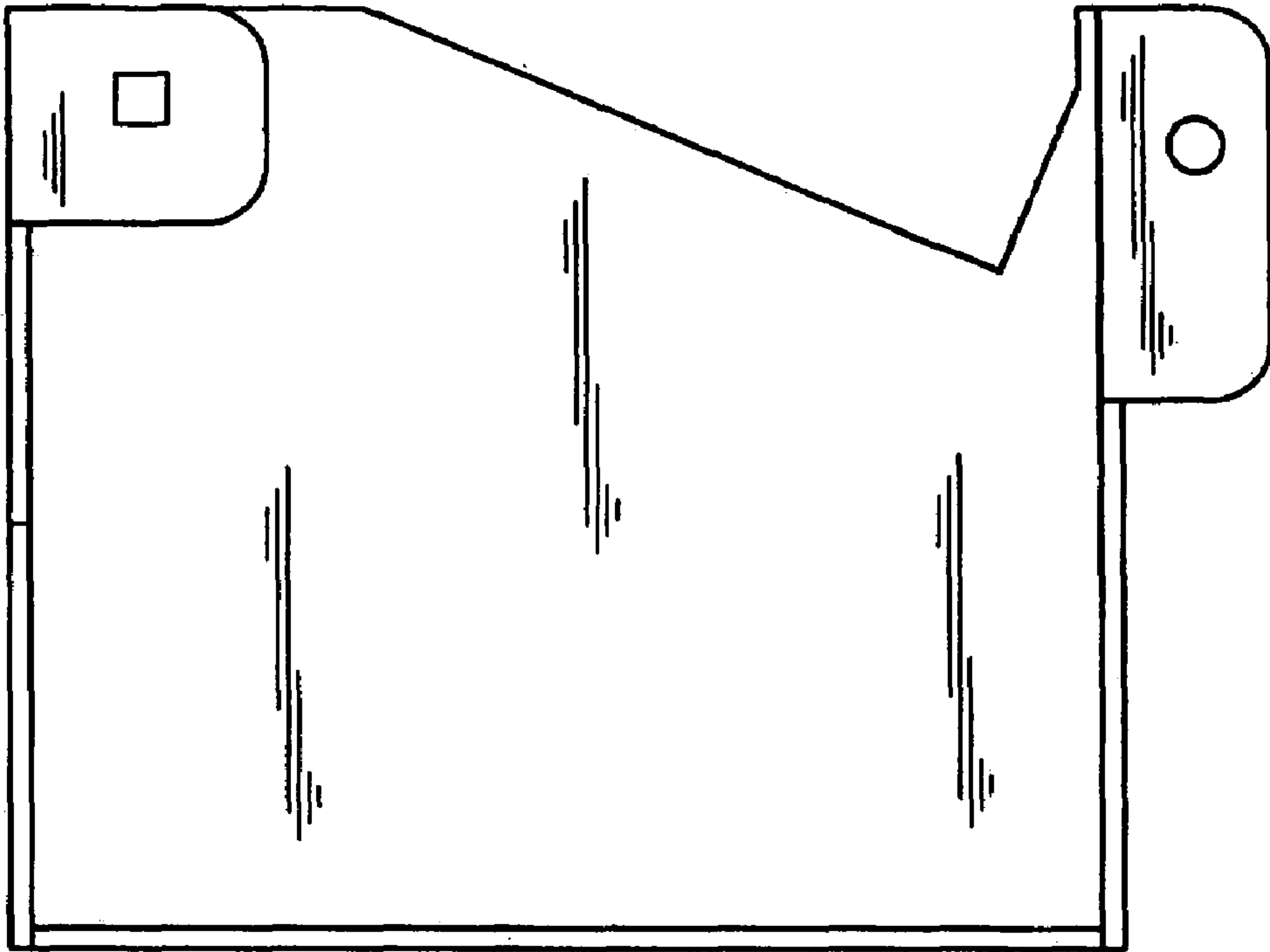

FIG. 5

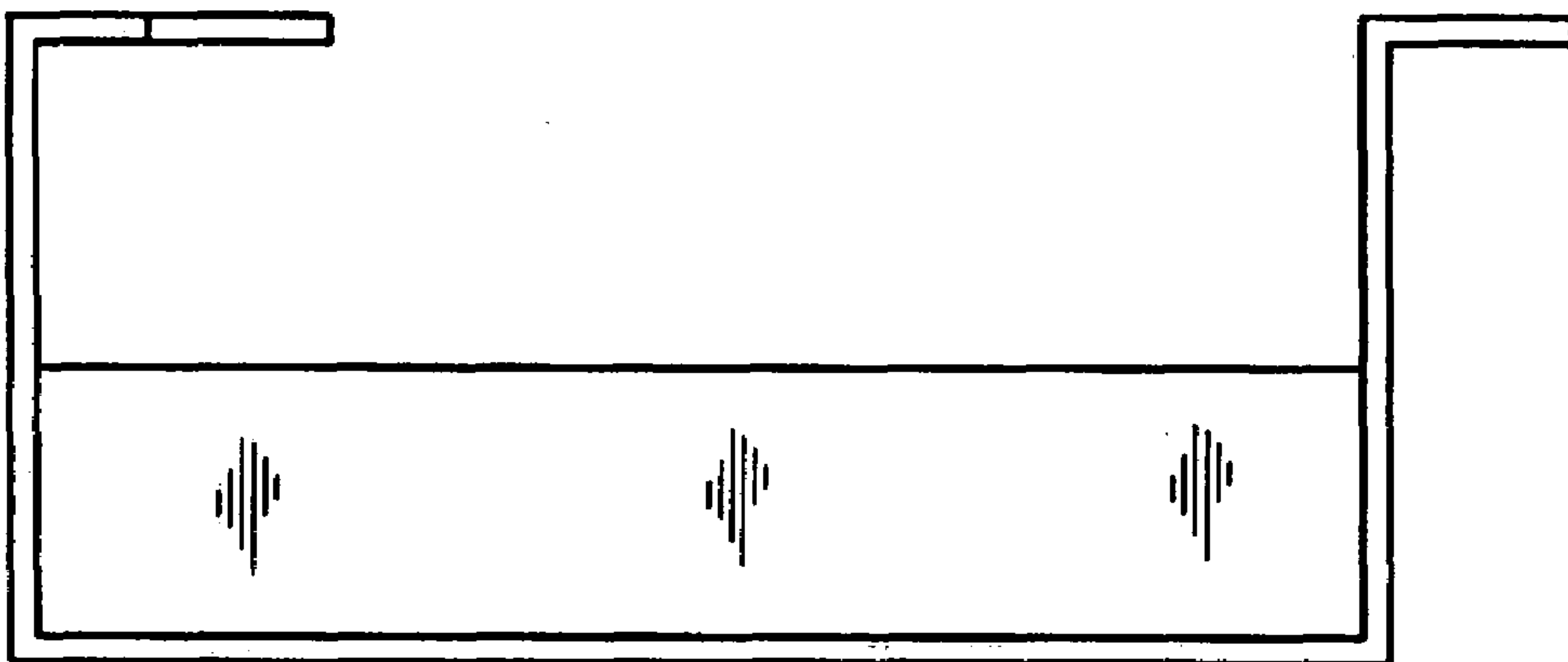

FIG. 6

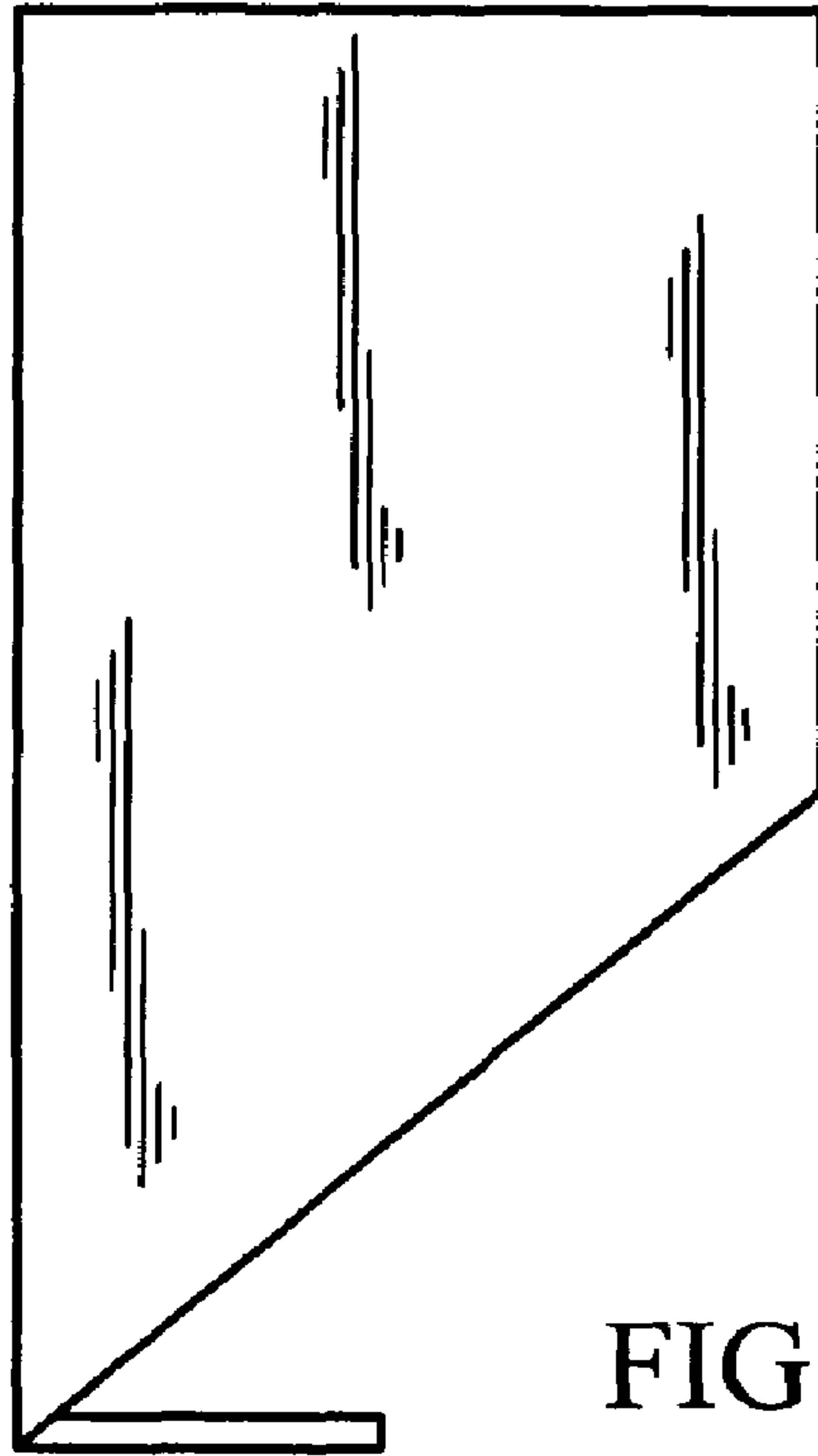

FIG. 7

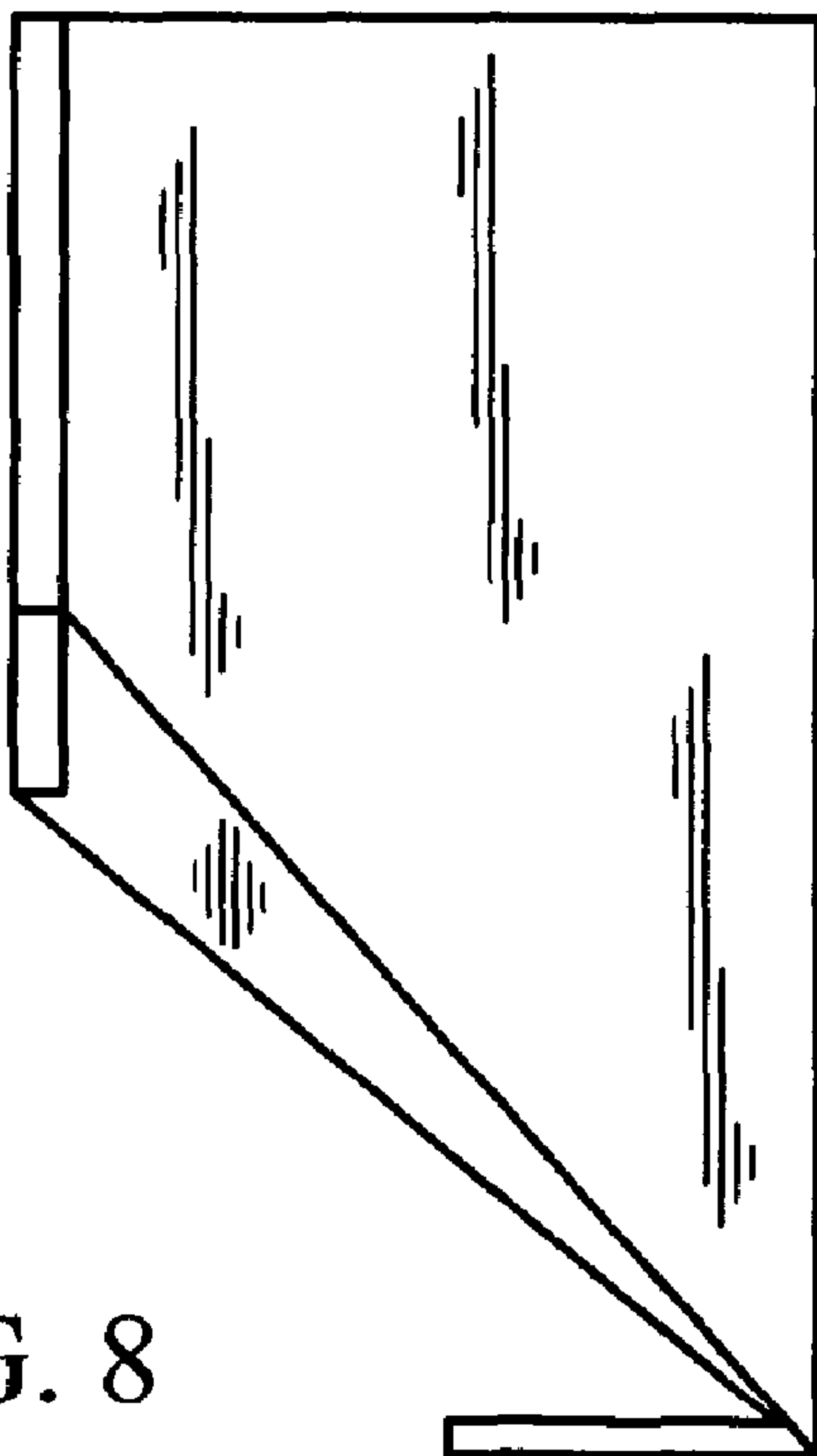

FIG. 8