



US00D557060S

(12) **United States Design Patent**
Swiss et al.

(10) **Patent No.:** **US D557,060 S**

(45) **Date of Patent:** **** Dec. 11, 2007**

(54) **CARAFE**

(75) Inventors: **Timothy Swiss**, Chicago, IL (US);
Antonio Belton, Richton Park, IL (US);
Katherine Cigliano, Chicago, IL (US)

(73) Assignee: **Walton Industries, Inc.**, Woodridge, IL (US)

(**) Term: **14 Years**

(21) Appl. No.: **29/236,815**

(22) Filed: **Aug. 23, 2005**

(51) **LOC (8) Cl.** **07-01**

(52) **U.S. Cl.** **D7/319; D7/317**

(58) **Field of Classification Search** D7/300,
D7/316-319, 321; 99/323.3; 215/12.1;
222/505, 131, 470, 144.5, 566; 220/4.01,
220/504; 210/85, 121, 282; D23/209; 62/457.3,
62/457.2

See application file for complete search history.

(56) **References Cited**

U.S. PATENT DOCUMENTS

D201,839 S * 8/1965 Erkers D7/317
D285,400 S * 9/1986 Zimmermann D7/317
D286,254 S * 10/1986 Zimmerman D7/317
D287,805 S * 1/1987 Zimmermann D7/317
D288,654 S * 3/1987 Nusse D7/317
D291,859 S * 9/1987 Zimmermann D7/321
D292,162 S * 10/1987 Zimmermann D7/317

D293,538 S * 1/1988 Zimmermann D7/317
D299,105 S * 12/1988 Sun D7/317
D308,153 S * 5/1990 Collins D7/322
D354,880 S * 1/1995 Huang D7/319
D386,934 S * 12/1997 Huang D7/319
D396,377 S * 7/1998 Tamura D7/319
D417,814 S * 12/1999 Huang D7/319
D428,757 S * 8/2000 Loffler et al. D7/319
D444,339 S * 7/2001 Huang D7/319
D454,468 S * 3/2002 Mano D7/318
D483,994 S * 12/2003 Boyle et al. D7/413

* cited by examiner

Primary Examiner—M. N. Pandozzi

(74) *Attorney, Agent, or Firm*—DLA Piper US LLP; R. Blake Johnston, Esq.

(57) **CLAIM**

The ornamental design for a carafe, as shown and described.

DESCRIPTION

FIG. 1 is a perspective view of the carafe;

FIG. 2 is a side elevational view of the carafe, the opposite side of which is an identical mirror image;

FIG. 3 is a front elevational view of the carafe;

FIG. 4 is a rear elevational view of the carafe.

FIG. 5 is a top plan view of the carafe; and,

FIG. 6 is a bottom plan view of the carafe.

1 Claim, 3 Drawing Sheets

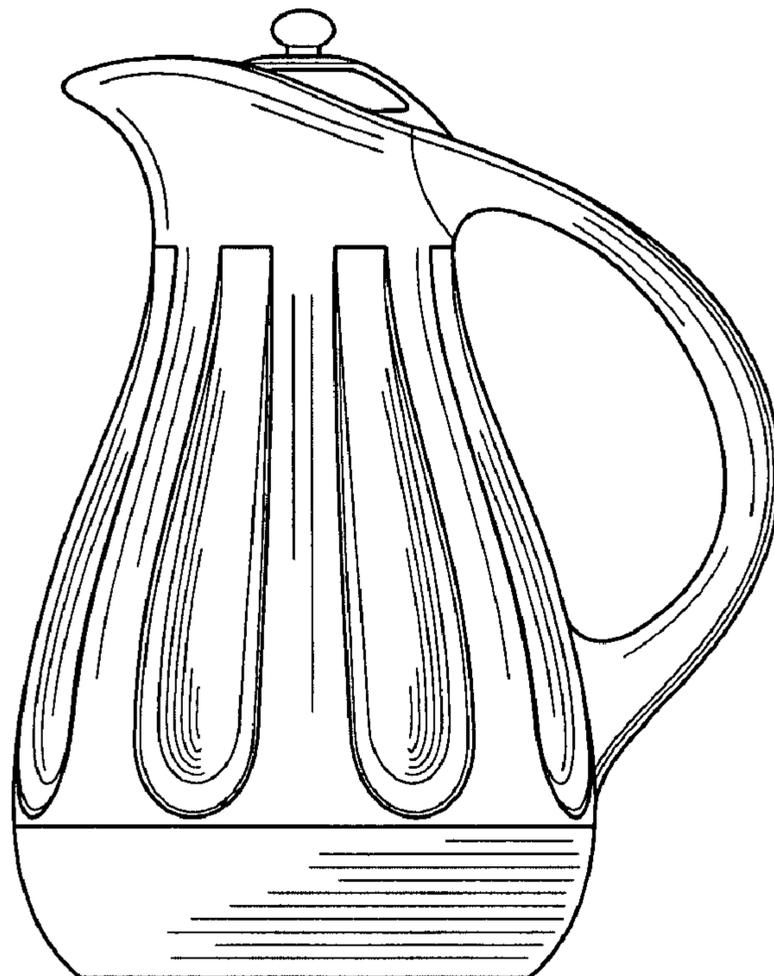

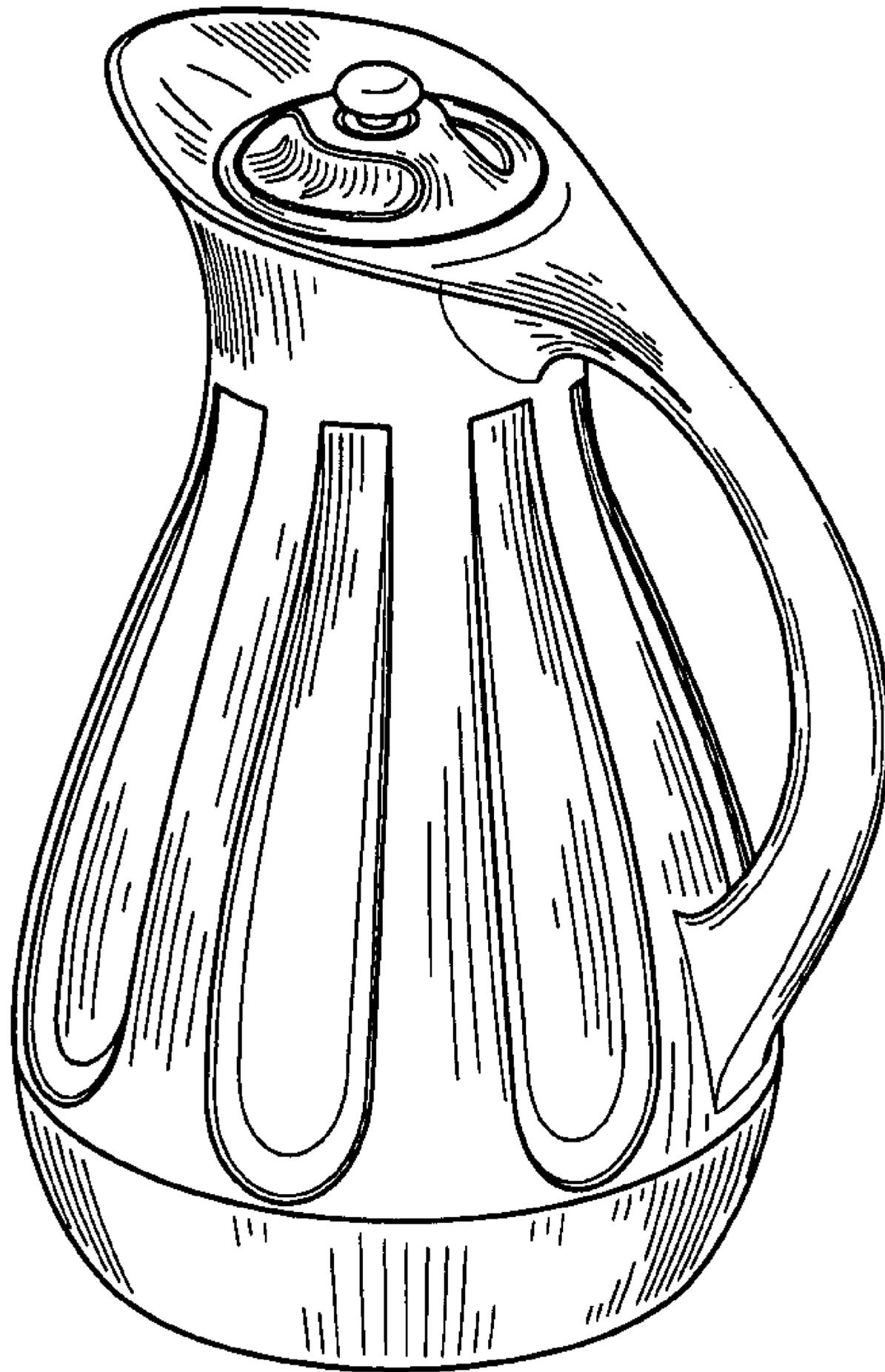

FIG. 1

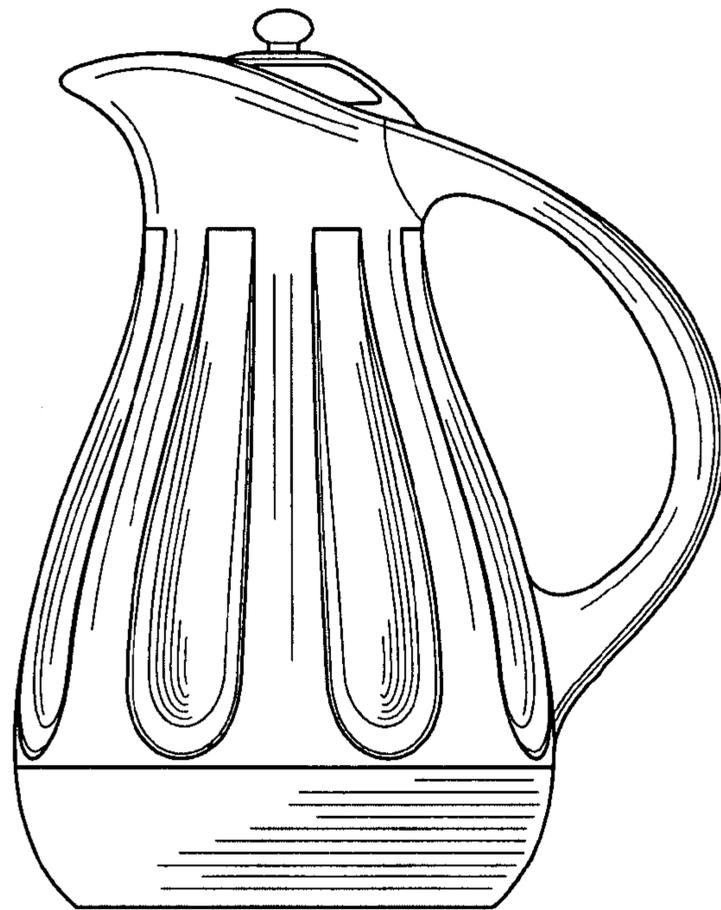

FIG. 2

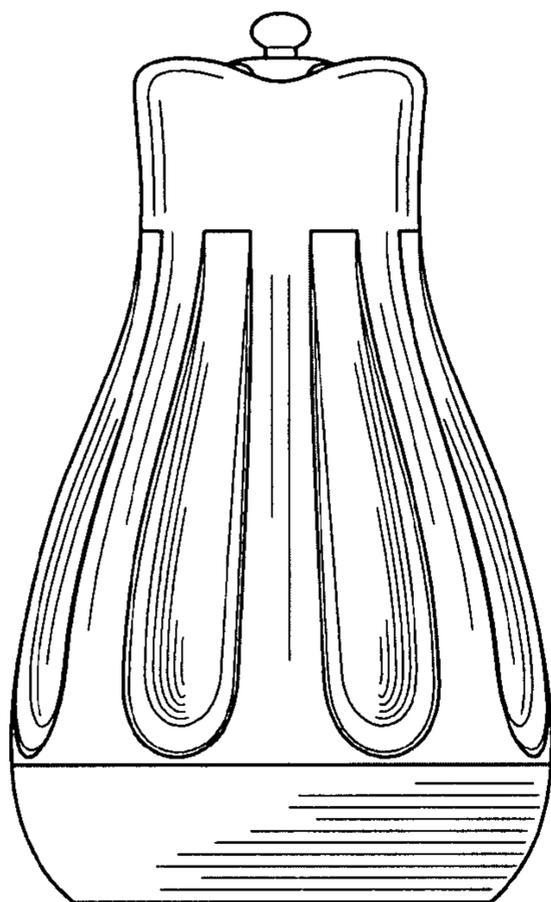

FIG. 3

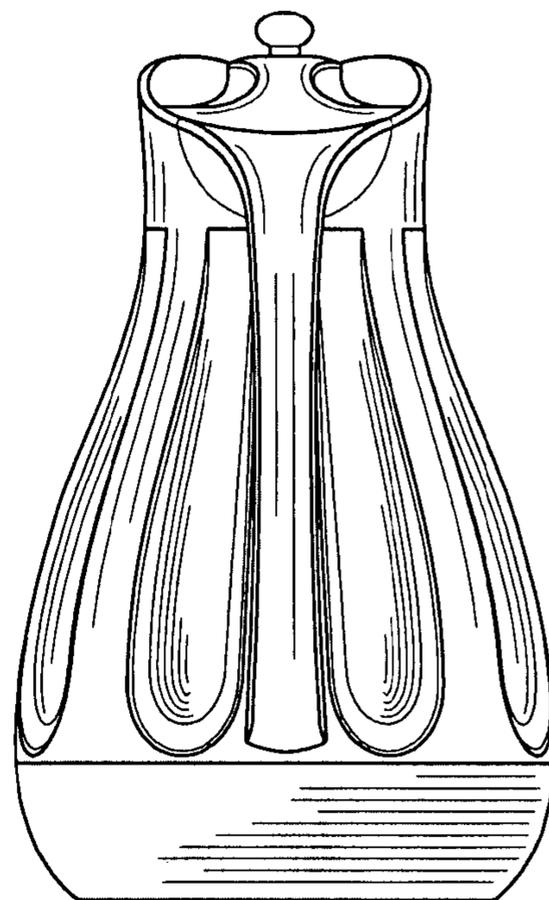

FIG. 4

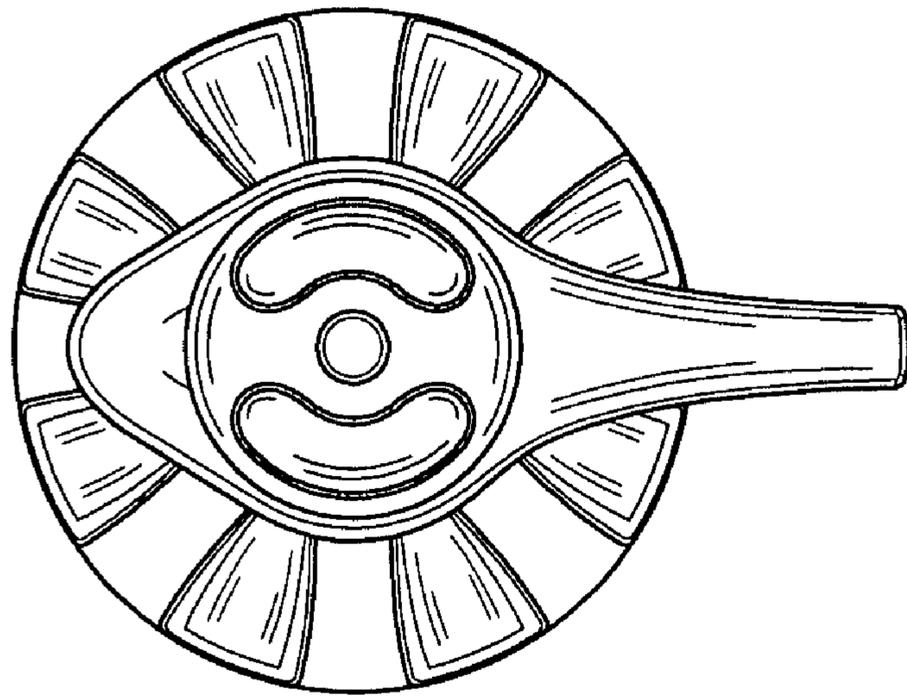

FIG. 5

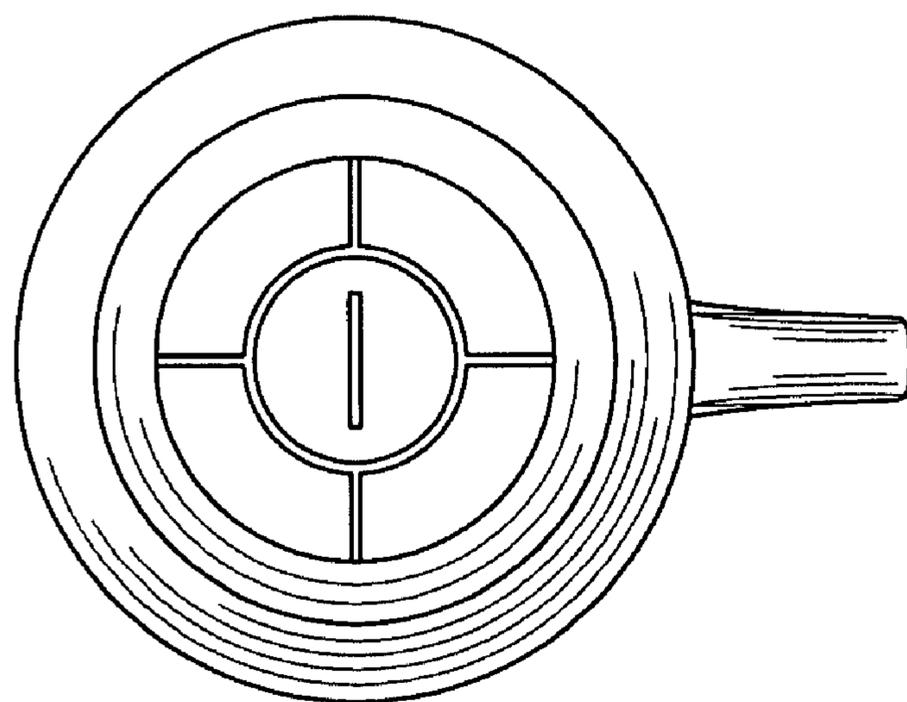

FIG. 6