



US00D557010S

(12) **United States Design Patent**
Gonzalez

(10) **Patent No.:** **US D557,010 S**

(45) **Date of Patent:** **** Dec. 11, 2007**

(54) **HANDBAG**

(75) Inventor: **Alvaro Gonzalez**, Florence (IT)

(73) Assignee: **J. Choo (Jersey) Limited**, St. Helier, Jersey (GB)

(**) Term: **14 Years**

(21) Appl. No.: **29/243,045**

(22) Filed: **Nov. 17, 2005**

(30) **Foreign Application Priority Data**

Sep. 9, 2005 (EP) 000401484-002

(51) **LOC (8) Cl.** **03-01**

(52) **U.S. Cl.** **D3/243; D3/321**

(58) **Field of Classification Search** D3/232, D3/234, 235, 237, 238, 239, 240, 241, 242, D3/243, 244, 245, 246, 303, 318, 321, 323, D3/324, 325, 326, 901; 150/100, 106, 107, 150/110, 111, 112, 114, 115, 117, 118, 119, 150/120, 123, 124, 125, 900; 190/100, 108, 190/109, 112, 113, 115, 116, 119, 121, 122, 190/123, 902; 383/6, 12, 13, 15, 16, 22, 383/24, 25, 30, 31, 37, 38, 40, 41, 42

See application file for complete search history.

(56) **References Cited**

U.S. PATENT DOCUMENTS

D471,707 S	3/2003	Galliano	
D472,046 S	3/2003	Galliano	
D472,374 S *	4/2003	Galliano	D3/243
D487,190 S	3/2004	Galliano	
D492,482 S *	7/2004	Hanley	D3/243
D500,593 S *	1/2005	Stulman	D3/243
D507,882 S *	8/2005	Gonzalez	D3/326
D529,281 S *	10/2006	Gonzalez	D3/243
D532,969 S *	12/2006	Fendi	D3/243

OTHER PUBLICATIONS

J. Choo (Jersey) Limited, Tulita Large Flap Hobo, Spring/Summer 2004 Catalogue.

U.S. Appl. No. 29/238,642, filed Sep. 19, 2005.

U.S. Appl. No. 29/238,635, filed Sep. 19, 2005.

* cited by examiner

Primary Examiner—Gary D. Watson

Assistant Examiner—Monica A. Weingart

(74) *Attorney, Agent, or Firm*—Fross Zelnick Lehrman & Zissu, P.C.; Lawrence E. Apolzon, Esq.

(57) **CLAIM**

The ornamental design for a handbag, as shown and described.

DESCRIPTION

FIG. 1 is a front perspective view of a handbag showing my new design;

FIG. 2 is a front elevational view thereof;

FIG. 3 is a rear elevational view thereof;

FIG. 4 is a left side elevational view thereof;

FIG. 5 is a right side elevational view thereof;

FIG. 6 is a top plan view thereof; and

FIG. 7 is a bottom plan view thereof;

FIG. 8 is a front perspective view of a second embodiment thereof;

FIG. 9 is a front elevational view thereof;

FIG. 10 is rear elevational view thereof;

FIG. 11 is a left side elevational view thereof;

FIG. 12 is a right side elevational view thereof;

FIG. 13 is a top plan view thereof; and,

FIG. 14 is a bottom plan view thereof.

The broken line showing of chains, handles, top buckle, handle rings, buckle, clasp bolts, and portions of the bag structure, is included for the purpose of illustrating environment and forms no part of the claimed design.

1 Claim, 14 Drawing Sheets

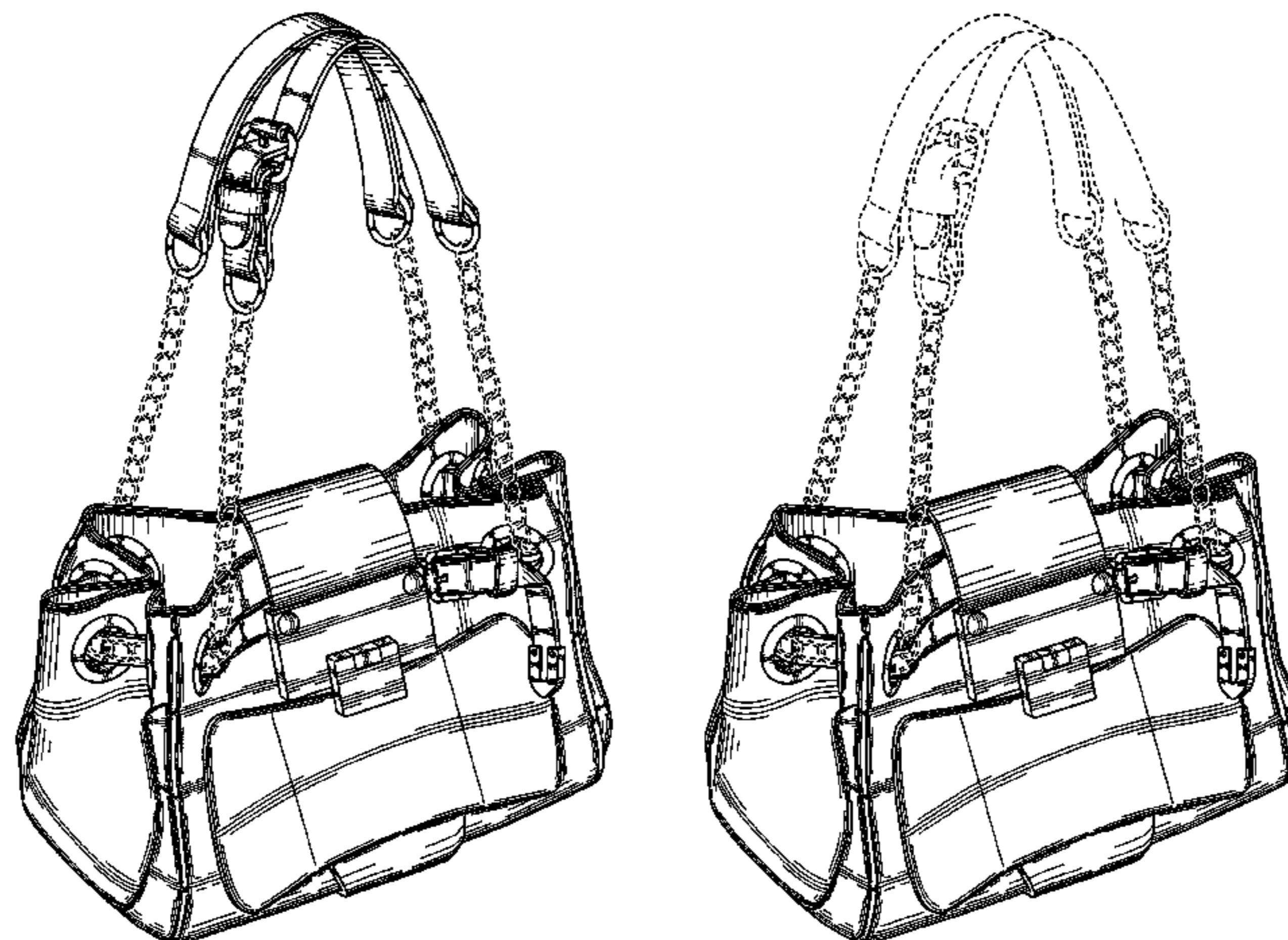

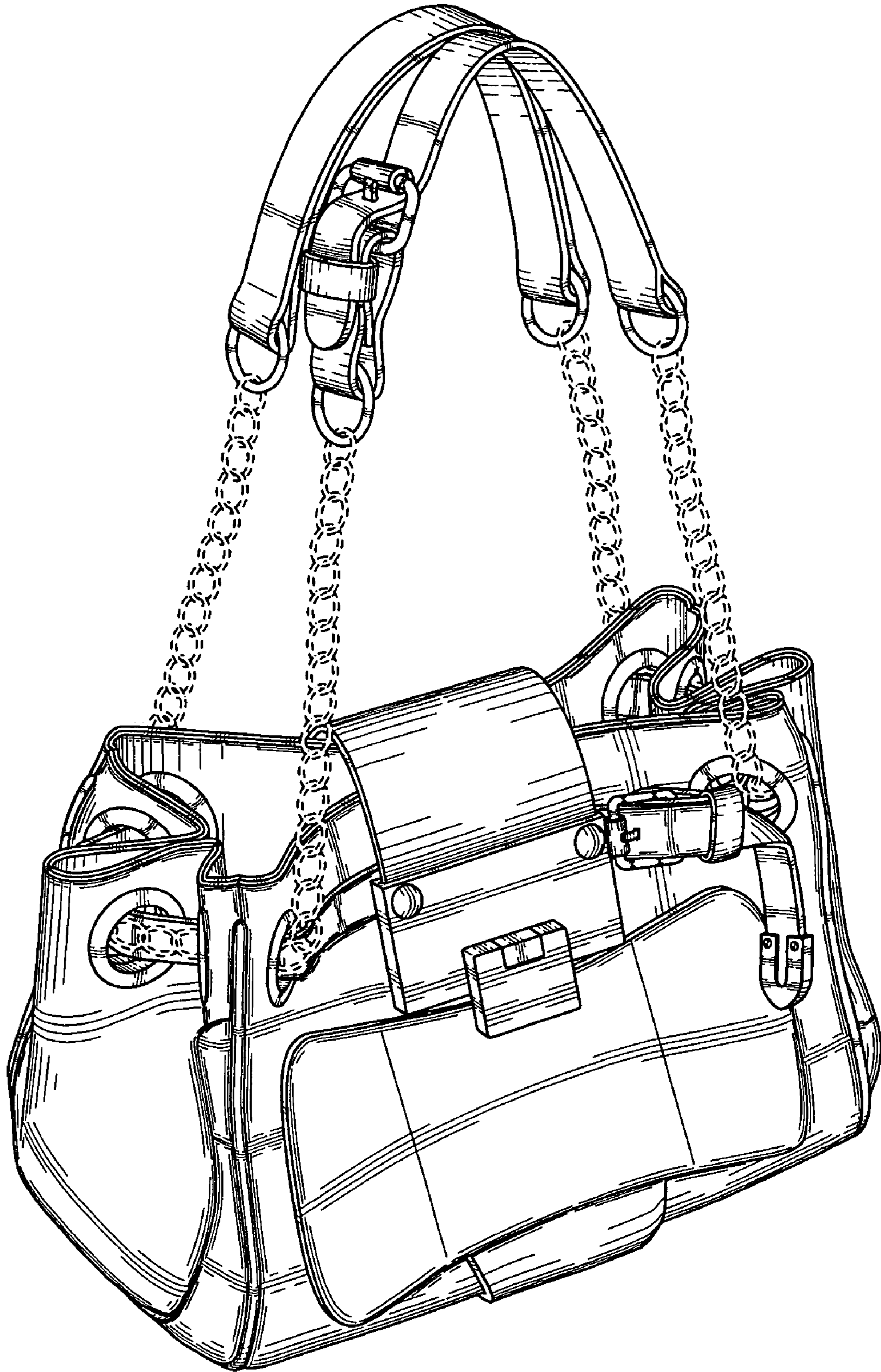

FIG. 1

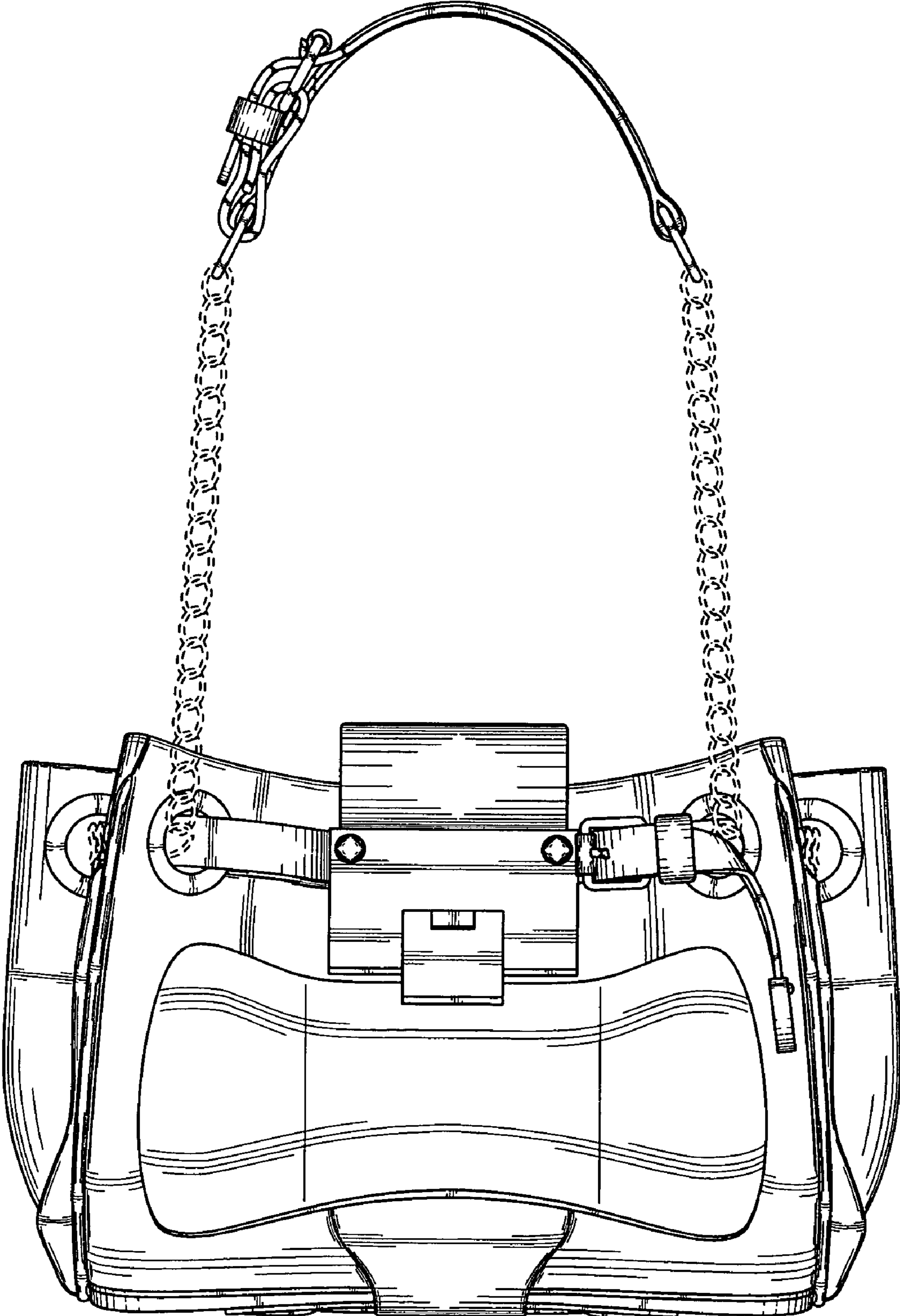

FIG. 2

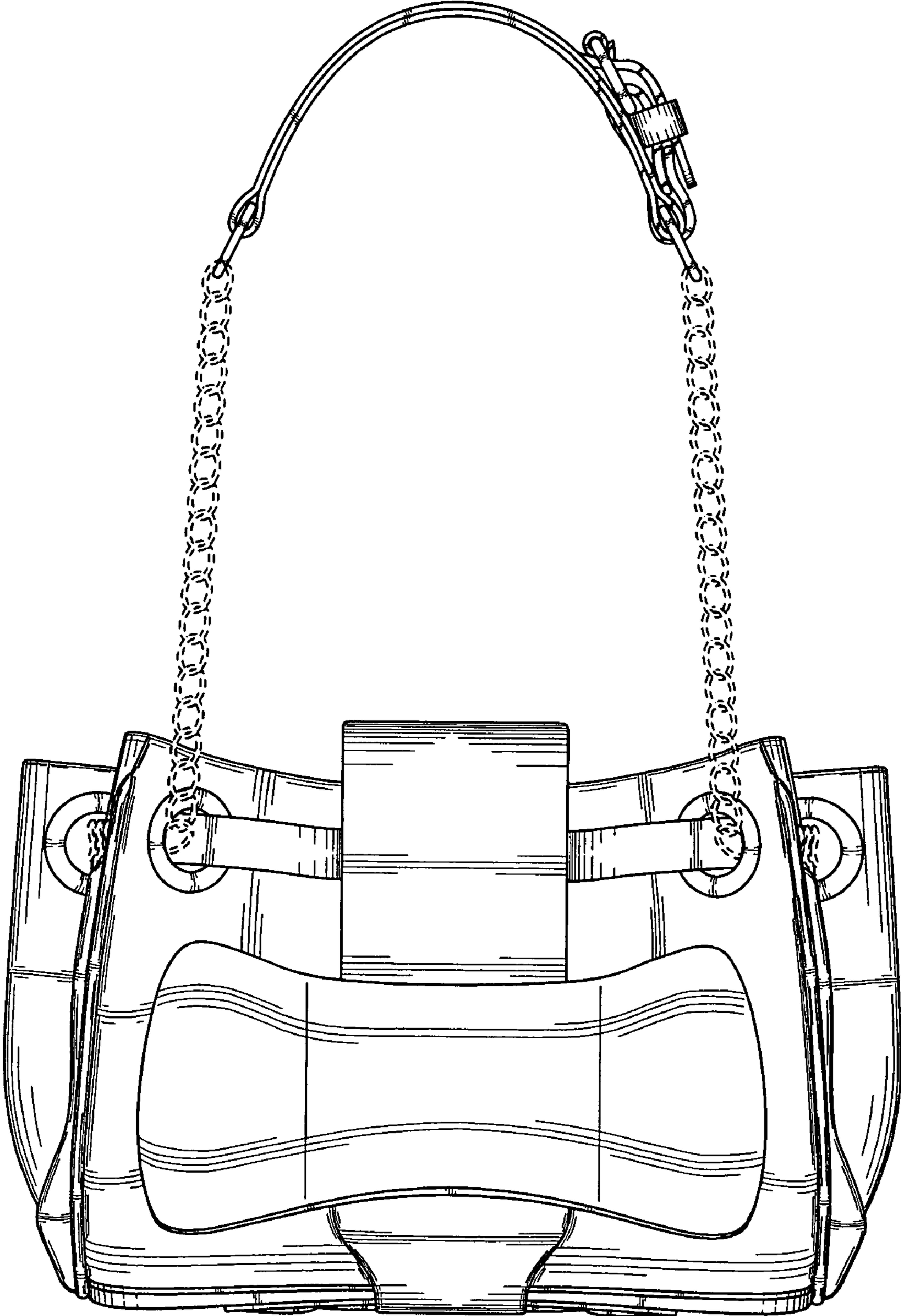

FIG. 3

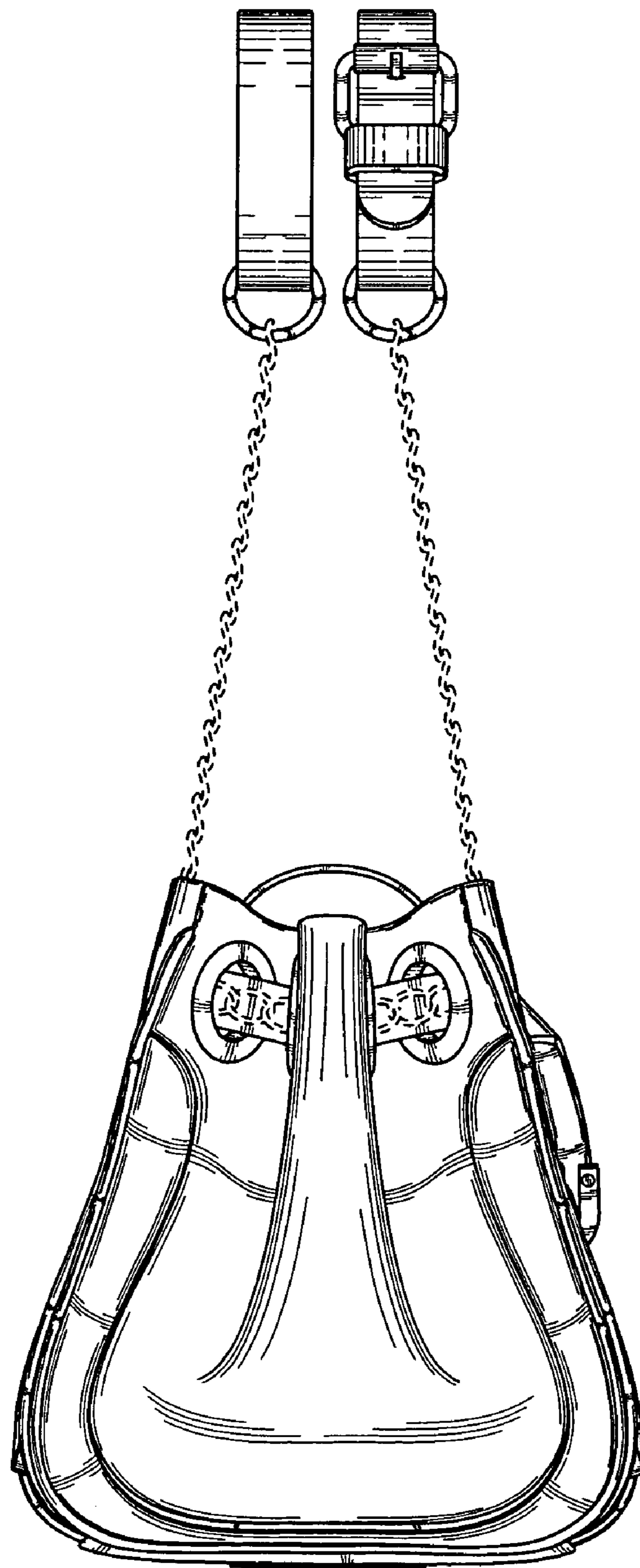

FIG. 4

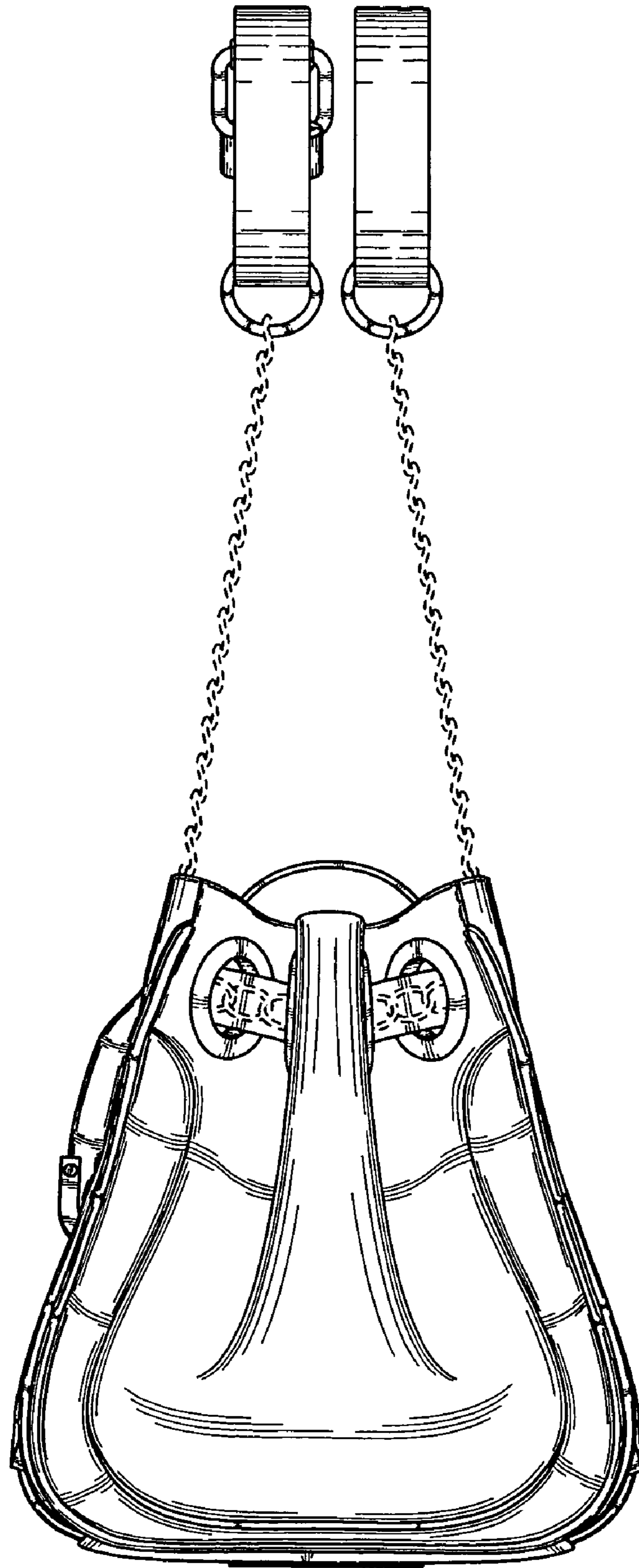

FIG. 5

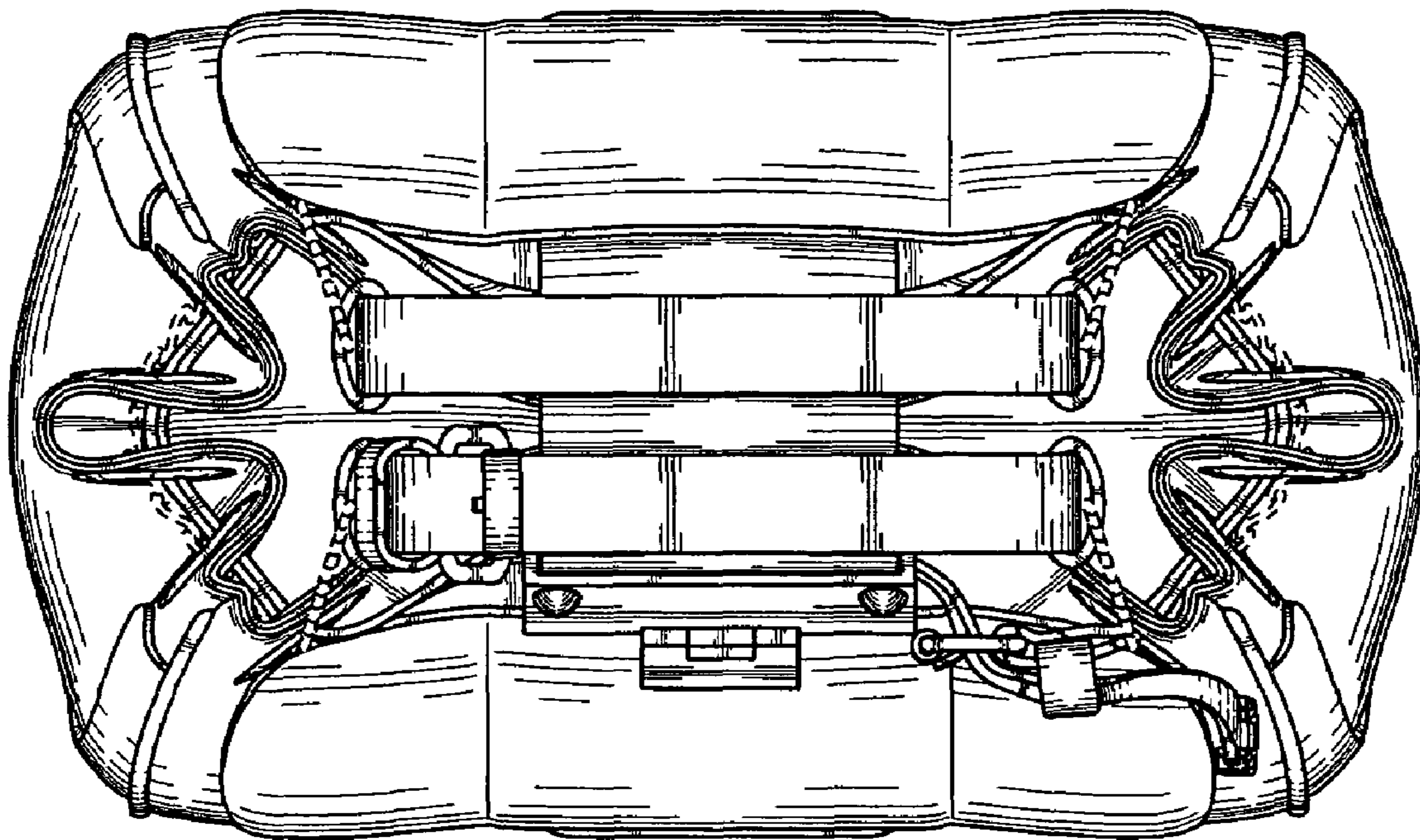

FIG. 6

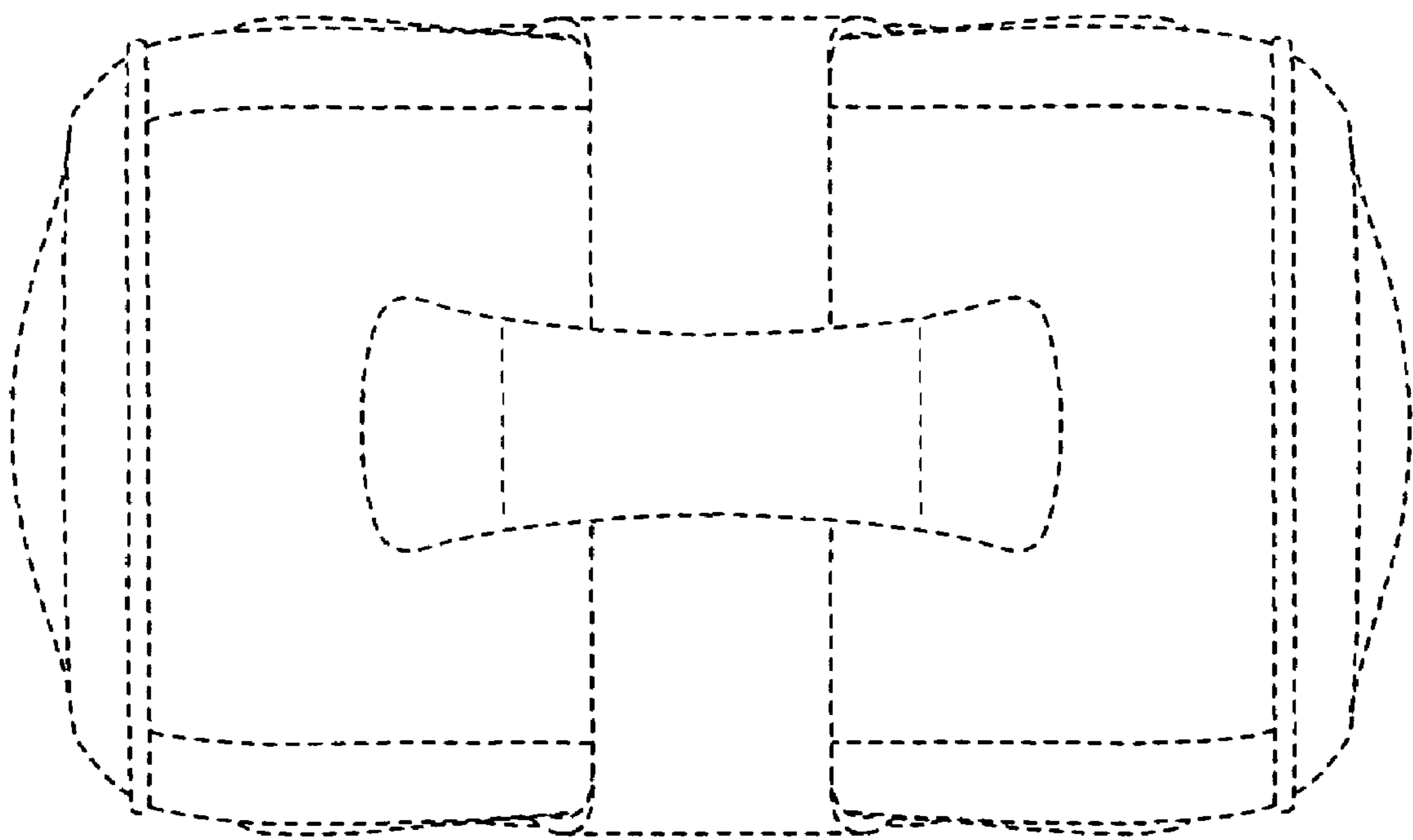

FIG. 7



FIG. 8

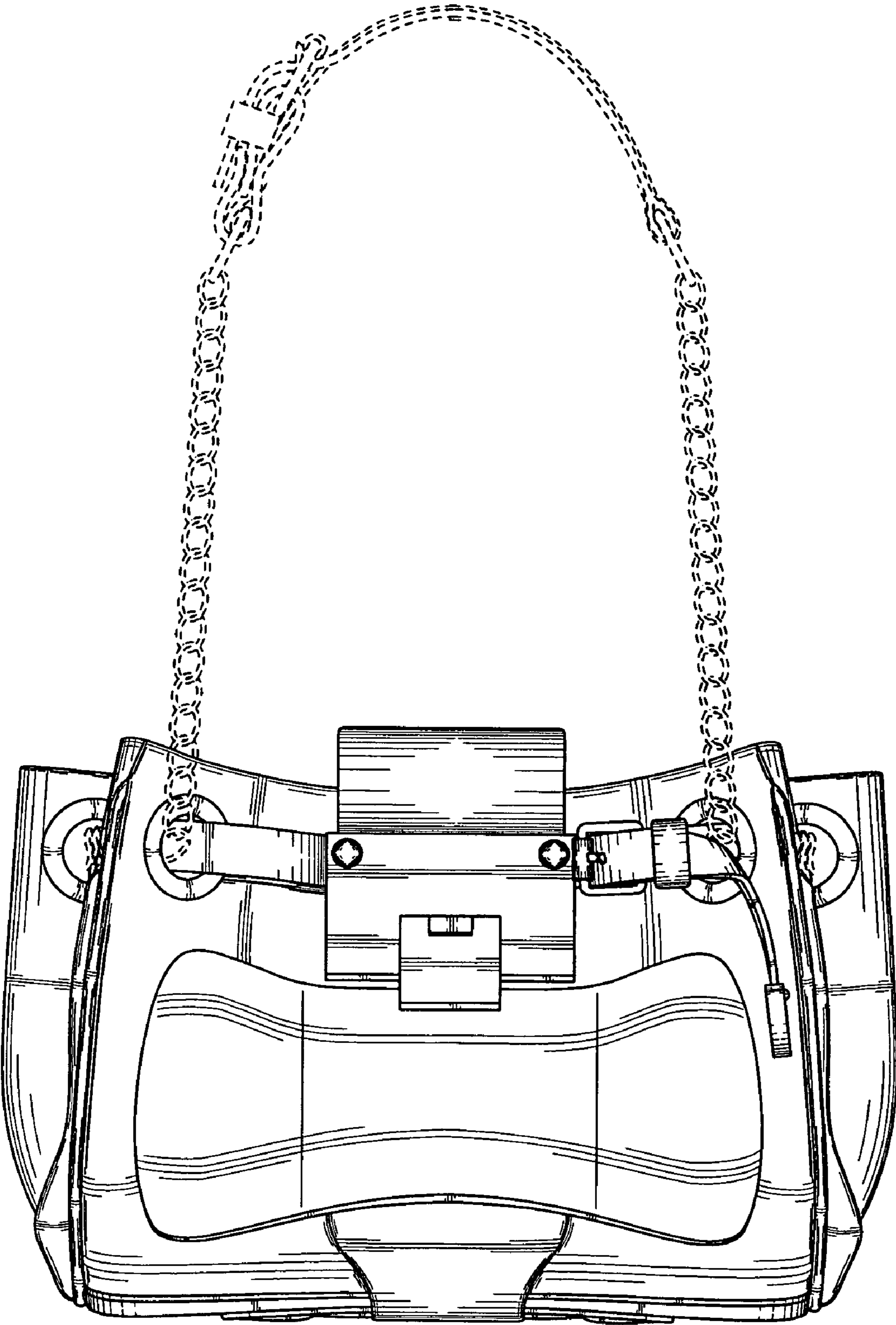

FIG. 9

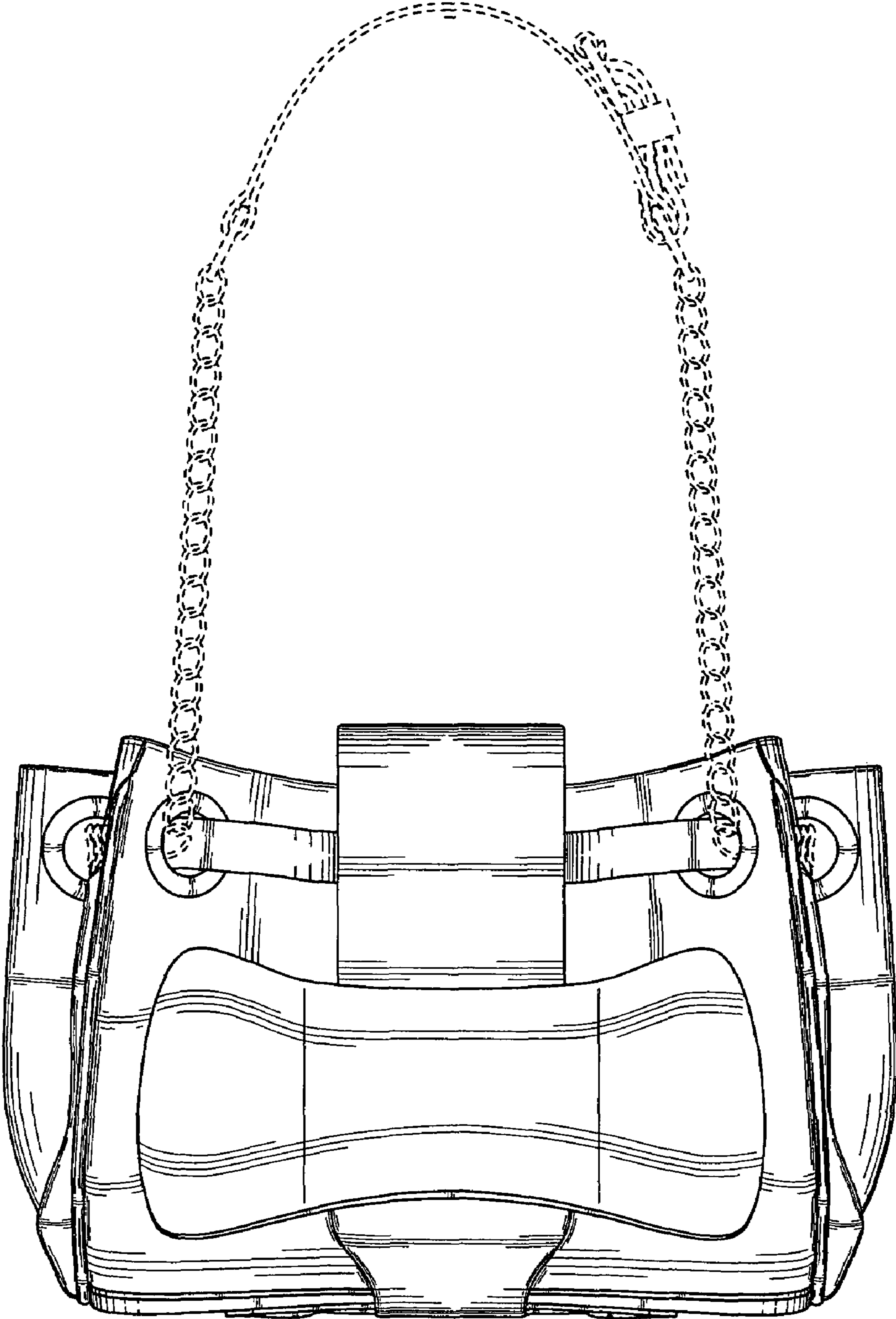

FIG. 10

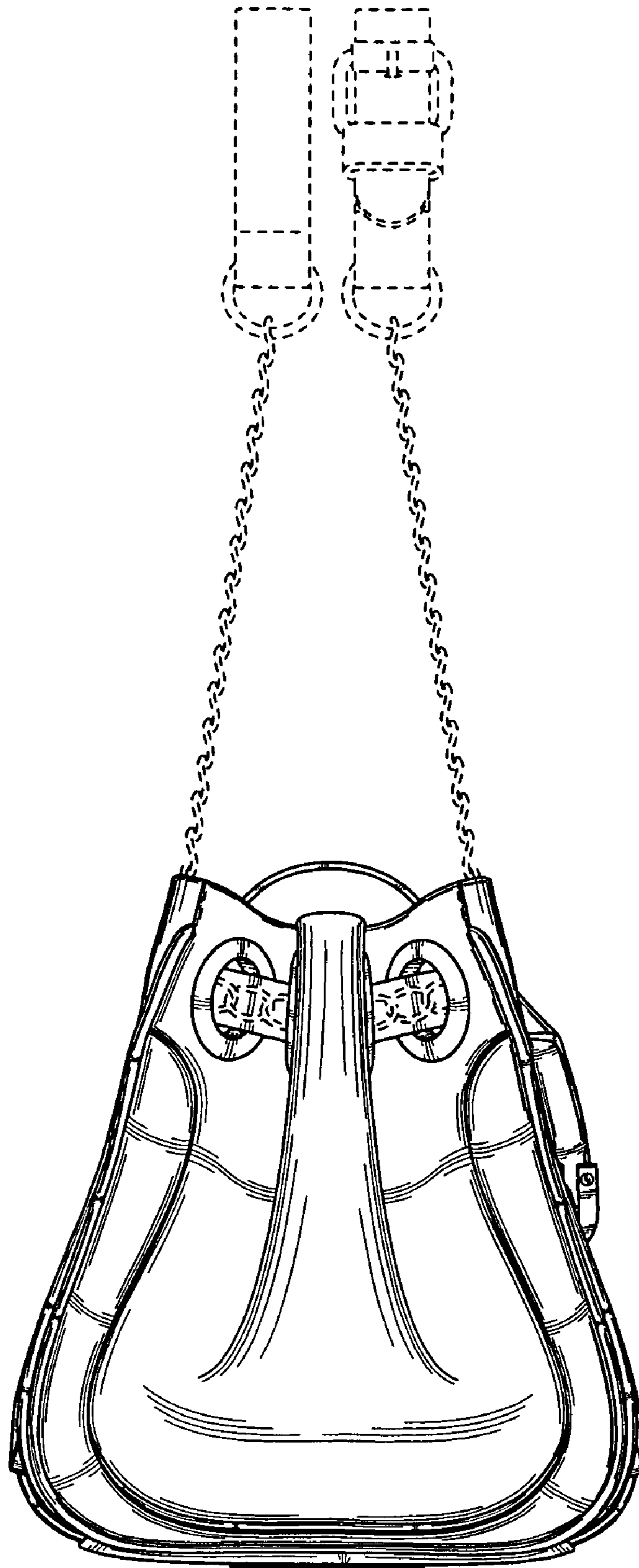

FIG. 11

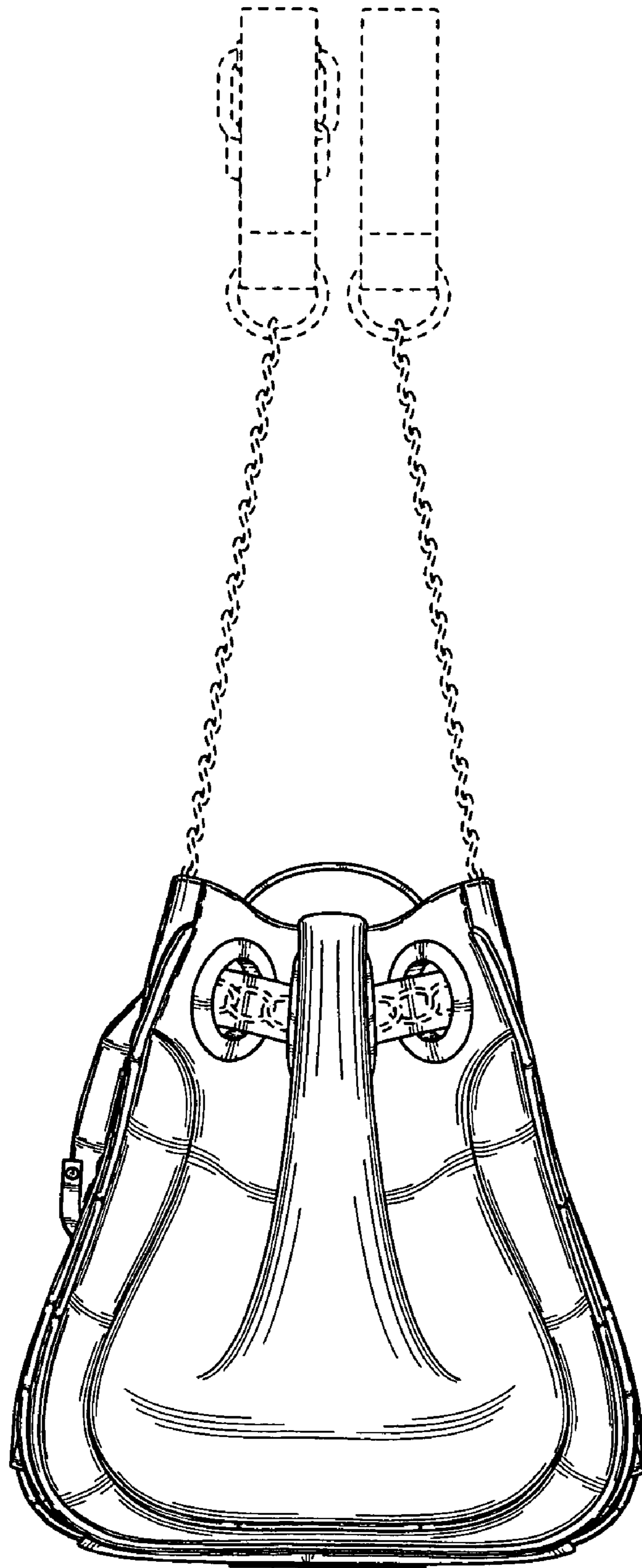

FIG. 12

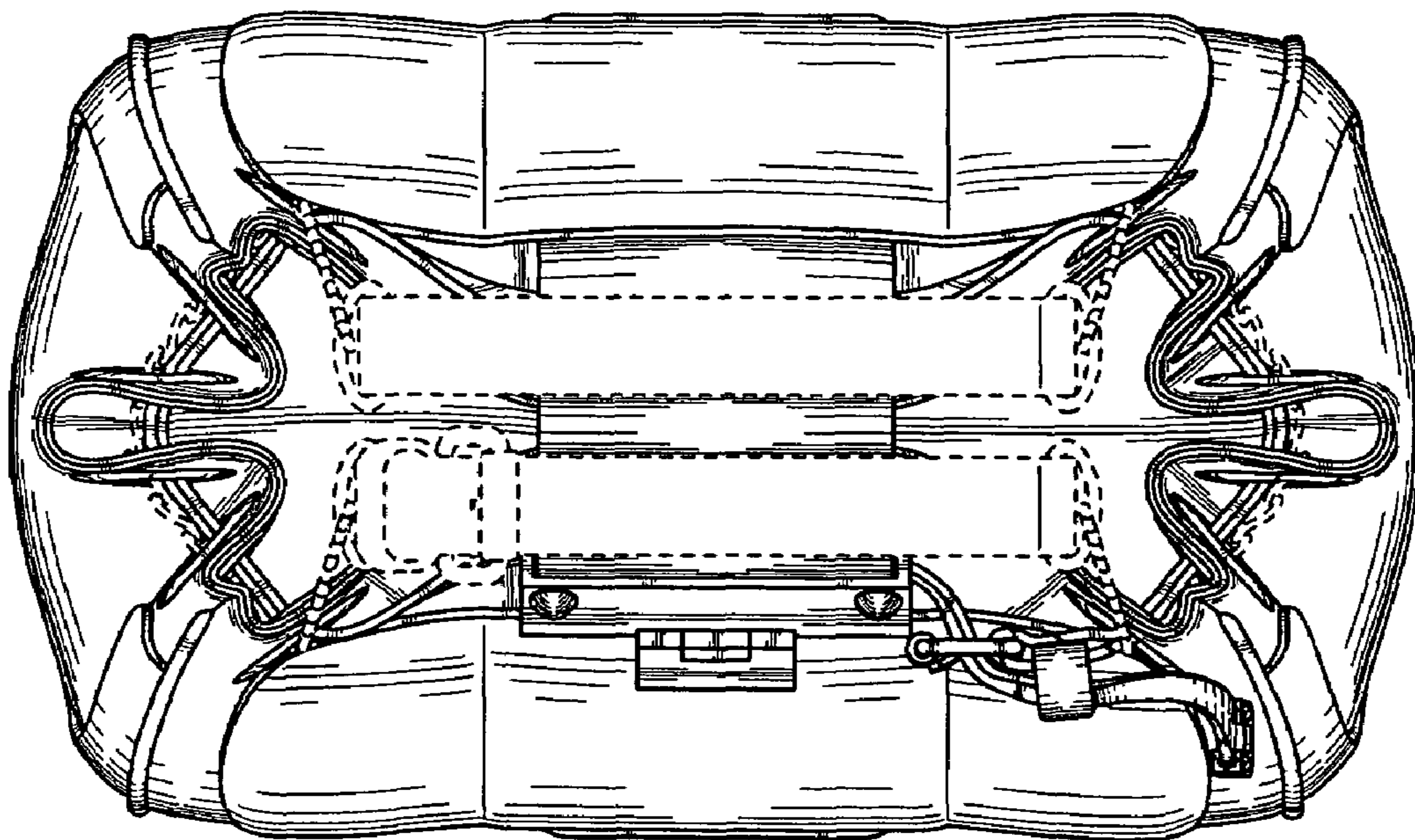

FIG. 13

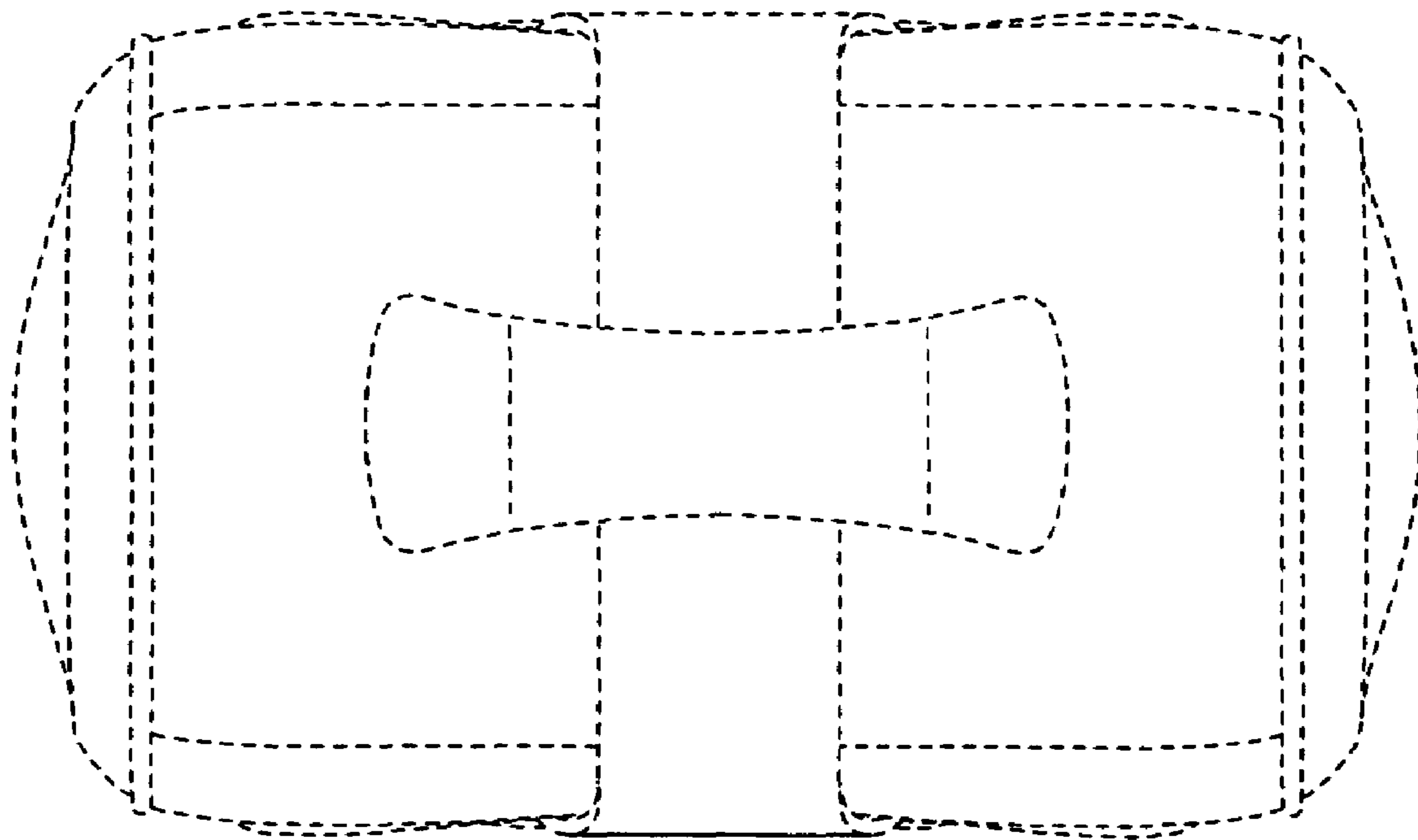

FIG. 14