

US00D556965S

(12) **United States Design Patent**
Richter

(10) **Patent No.:** **US D556,965 S**

(45) **Date of Patent:** **** Dec. 4, 2007**

(54) **DOUBLE BUCKET WASHER UNIT**

(75) Inventor: **Gary M. Richter**, Waukesha, WI (US)

(73) Assignee: **DCI Marketing, Inc.**, Milwaukee, WI (US)

(**) Term: **14 Years**

(21) Appl. No.: **29/267,377**

(22) Filed: **Oct. 12, 2006**

(51) **LOC (8) Cl.** **08-99**

(52) **U.S. Cl.** **D32/35; D32/1**

(58) **Field of Classification Search** D32/35,
D32/53, 1, 6, 11; 134/164, 188, 192, 195,
134/135, 200; 15/320-323, 339, 314
See application file for complete search history.

(56) **References Cited**

U.S. PATENT DOCUMENTS

D167,445 S *	8/1952	Cook, Jr.	D32/11
D216,277 S *	12/1969	James	D32/53
D227,148 S *	6/1973	Oas	D32/53
4,759,470 A	7/1988	Jacobs		
4,948,004 A	8/1990	Chich		
D348,337 S *	6/1994	O'Brien et al.	D32/1
D348,755 S *	7/1994	Perry	D32/53

D362,941 S *	10/1995	Delmerico et al.	D32/53
6,058,560 A *	5/2000	Gab et al.	15/339
D436,361 S *	1/2001	Yu-Chin	D15/8
6,905,039 B2 *	6/2005	Richter et al.	220/23.83

* cited by examiner

Primary Examiner—Pamela J. Burgess

(74) *Attorney, Agent, or Firm*—Brian G Gilpin; Godfrey & Kahn, S.C.

(57) **CLAIM**

I claim the ornamental design for a double bucket washer unit, as shown and described.

DESCRIPTION

FIG. 1 is a perspective view of a double bucket washer unit showing my new design;

FIG. 2 is a front view of the unit;

FIG. 3 is a back view of the unit;

FIG. 4 is a top plan view of the unit;

FIG. 5 is a bottom plan view of the unit;

FIG. 6 is a right side view of the unit; and,

FIG. 7 is a left side view of the unit.

1 Claim, 3 Drawing Sheets

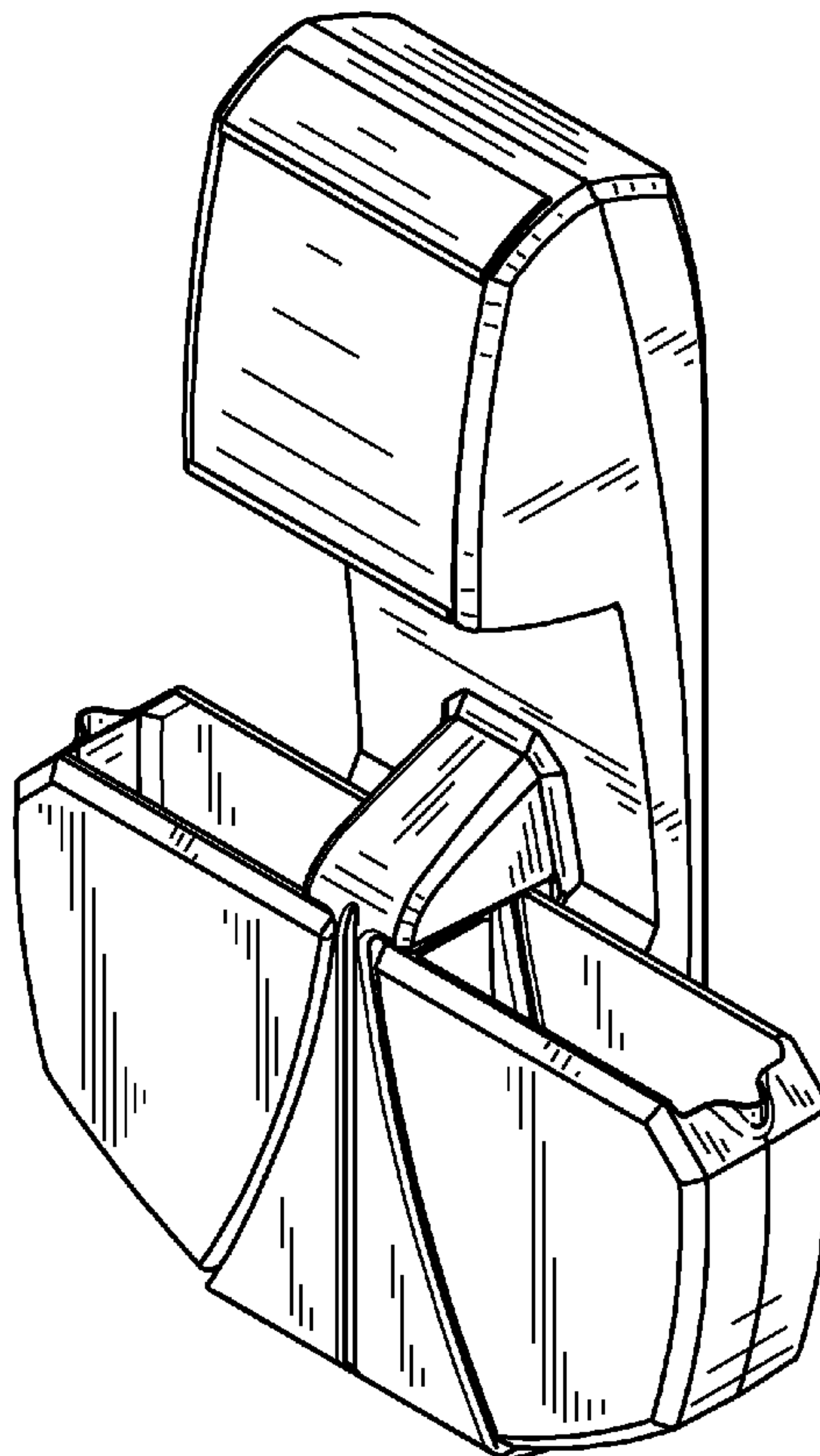

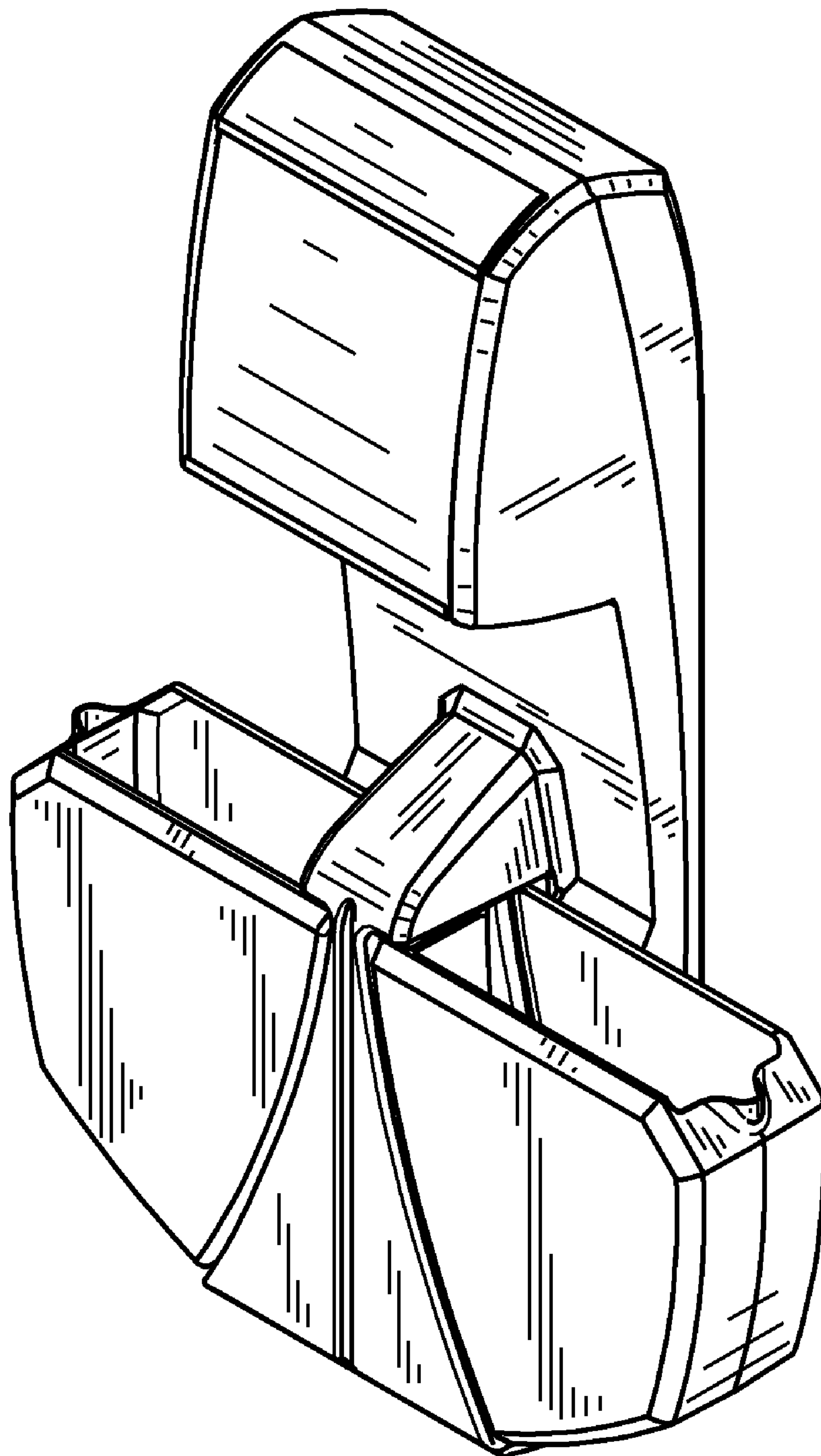

FIG. 1

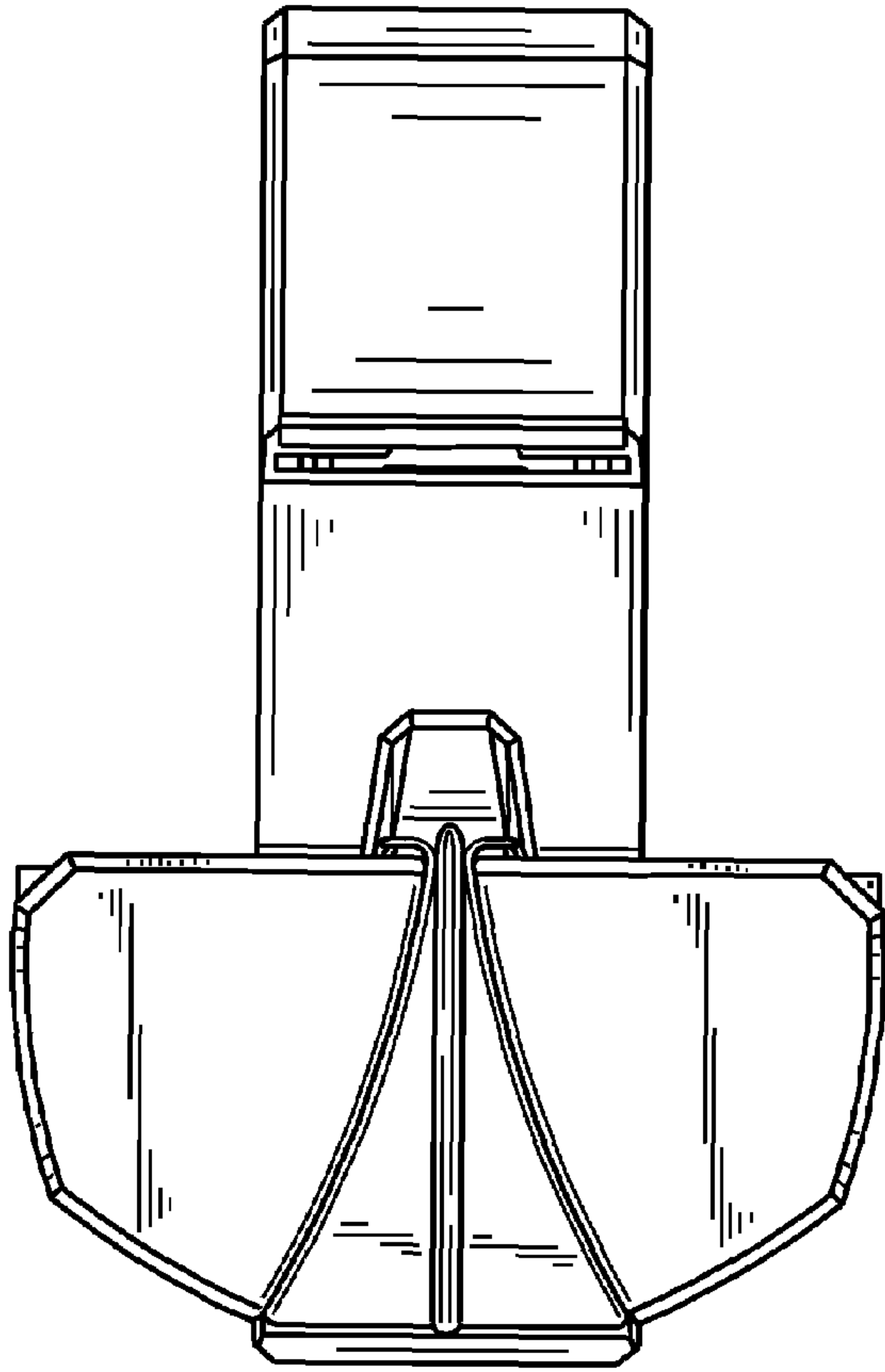

FIG. 2

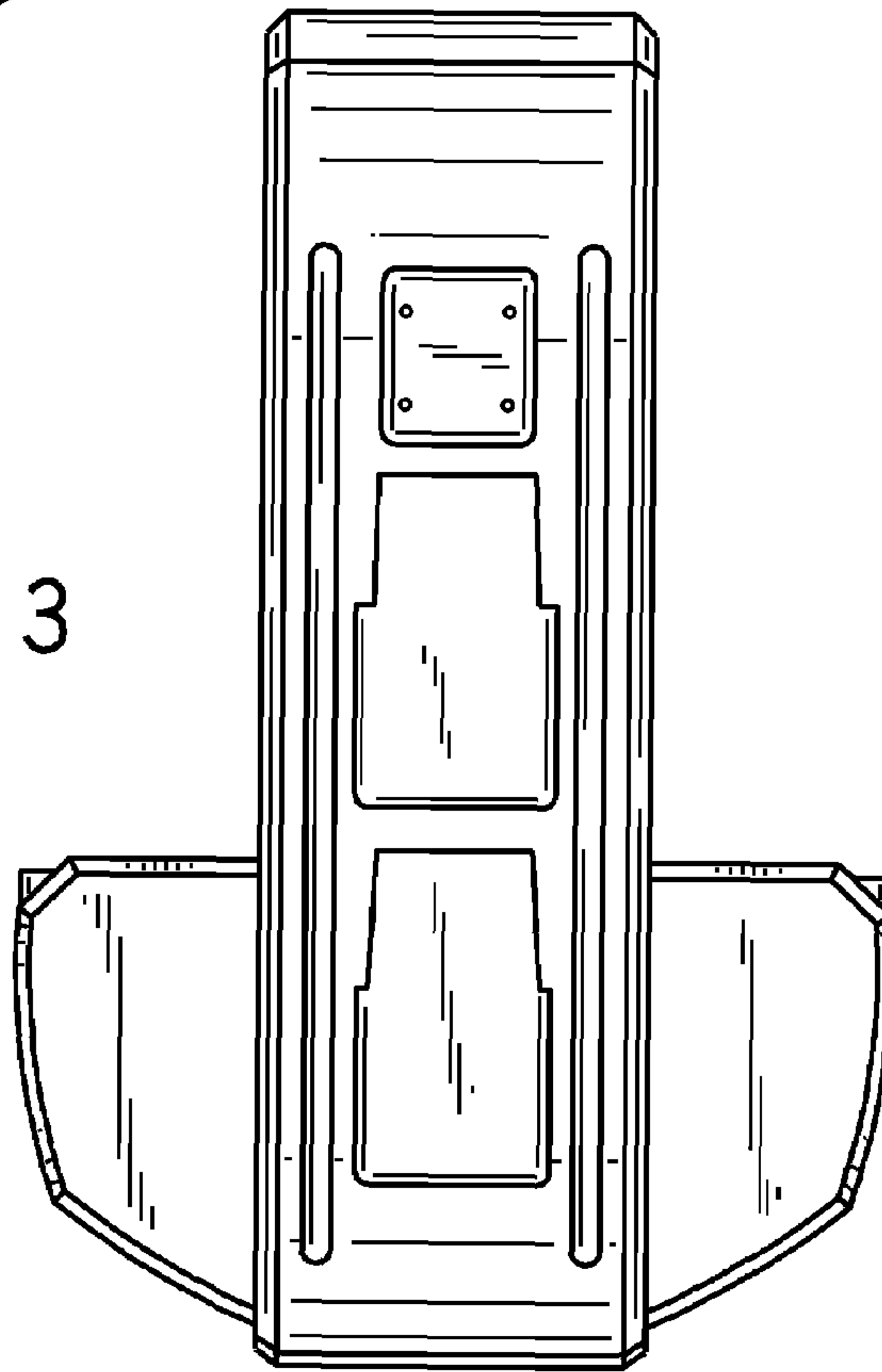

FIG. 3

FIG. 4

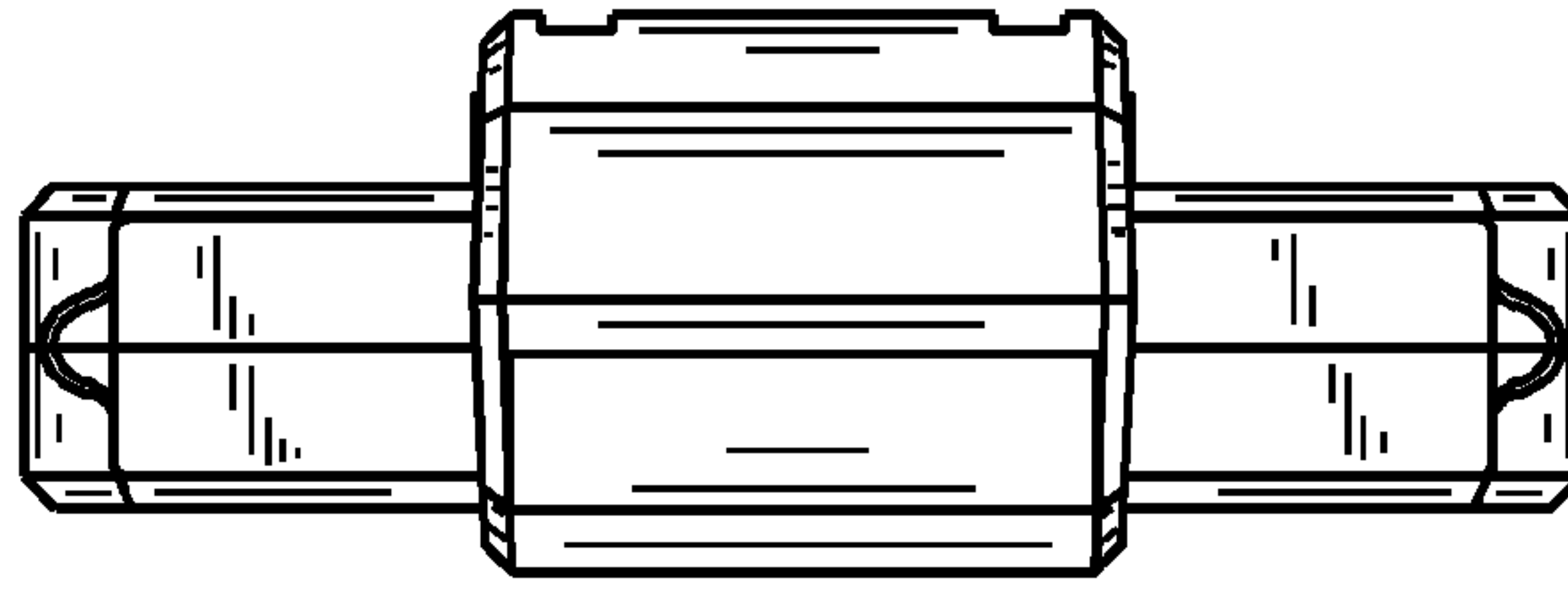

FIG. 5

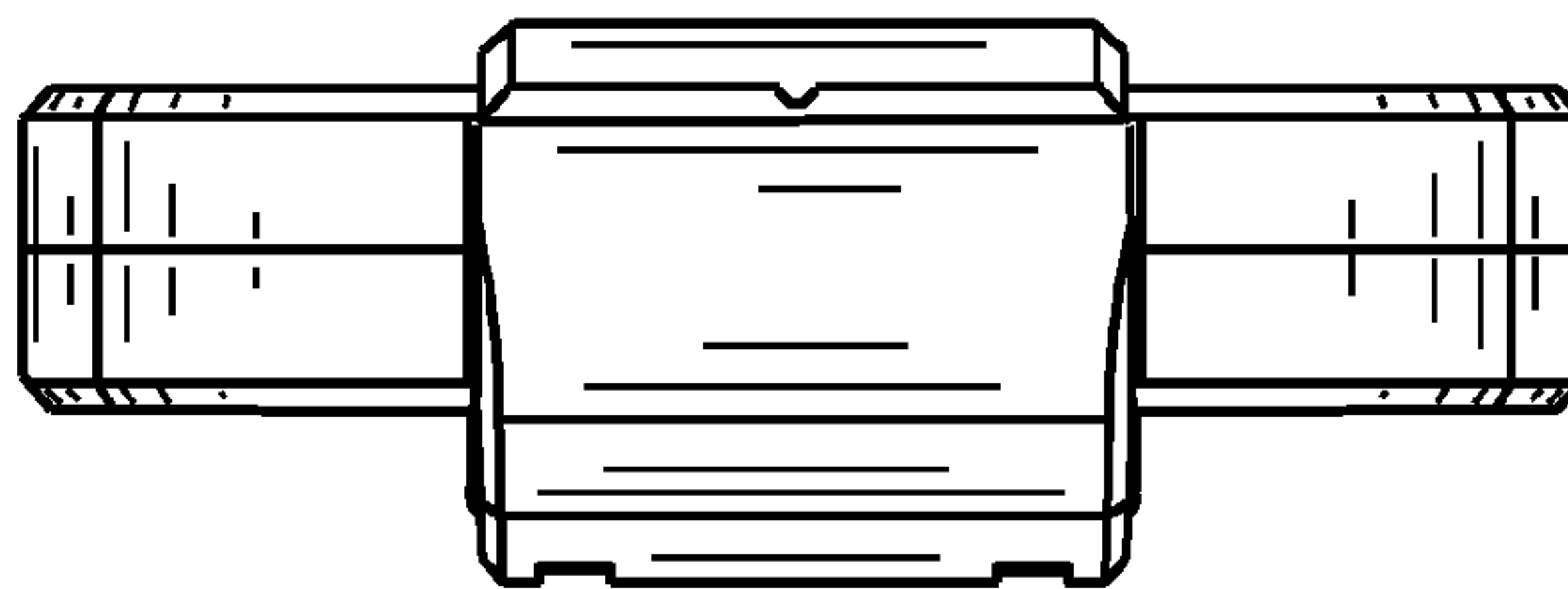

FIG. 6

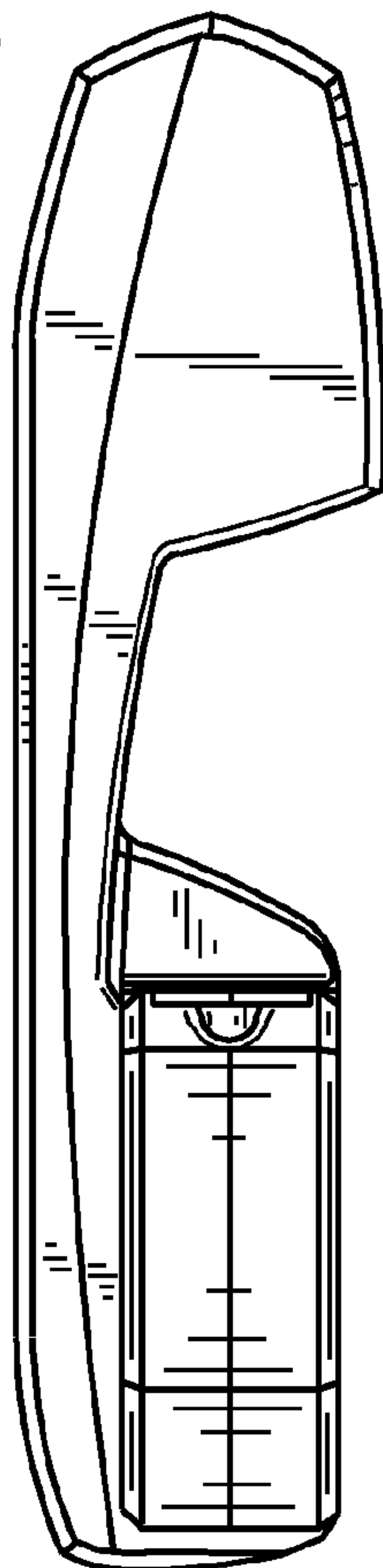

FIG. 7

