



US00D556944S

(12) **United States Design Patent**  
**Brookins**

(10) **Patent No.:** **US D556,944 S**

(45) **Date of Patent:** **\*\* Dec. 4, 2007**

(54) **LIGHT FIXTURE SUPPORT**

(75) Inventor: **Walter Brookins**, Dallas, TX (US)

(73) Assignee: **Craftmade International, Inc.**,  
Coppell, TX (US)

(\*\*) Term: **14 Years**

(21) Appl. No.: **29/285,159**

(22) Filed: **Mar. 22, 2007**

(51) **LOC (8) Cl.** ..... **26-99**

(52) **U.S. Cl.** ..... **D26/144**

(58) **Field of Classification Search** ..... D26/142,  
D26/154, 155, 141, 91, 90, 88, 86, 85, 84,  
D26/81, 156, 153, 145, 144, 143; D23/411;  
362/406, 405, 147, 403, 404, 408, 452, 453,  
362/454

See application file for complete search history.

(56) **References Cited**

**U.S. PATENT DOCUMENTS**

D50,211 S *	1/1917	Wagner et al.	.....	D26/88
D302,479 S *	7/1989	Bohler	.....	D26/81
D366,714 S *	1/1996	Porter	.....	D26/81
D384,432 S *	9/1997	Octavio	.....	D26/84
D421,663 S *	3/2000	Von Kluck	.....	D26/144
D422,375 S *	4/2000	Milicia	.....	D26/88
D427,707 S *	7/2000	Dolan	.....	D26/85
D430,690 S *	9/2000	Miranda	.....	D26/84
D431,665 S *	10/2000	Hsieh	.....	D26/85

D433,525 S *	11/2000	Hsieh	.....	D26/84
D441,896 S *	5/2001	Hsu	.....	D26/85
D498,869 S *	11/2004	Dolan	.....	D26/81
D532,545 S *	11/2006	Miranda	.....	D26/142

\* cited by examiner

*Primary Examiner*—Freda S. Nunn

*Assistant Examiner*—Kevin K Rudzinski

(74) *Attorney, Agent, or Firm*—Munsch, Hardt, Kopf & Harr, P.C.

(57) **CLAIM**

The ornamental design for a light fixture support, as shown and described.

**DESCRIPTION**

FIG. 1 is a perspective view of the light fixture support showing my new design;

FIG. 2 front elevational view thereof;

FIG. 3 is a rear elevational view thereof;

FIG. 4 is a right side elevational view; the left side being a mirror image thereof;

FIG. 5 is a top plan view thereof; and,

FIG. 6 is a bottom plan view thereof.

The broken line showing of the light fixture is included for the purpose of illustration only and forms no part of the claimed design.

**1 Claim, 5 Drawing Sheets**

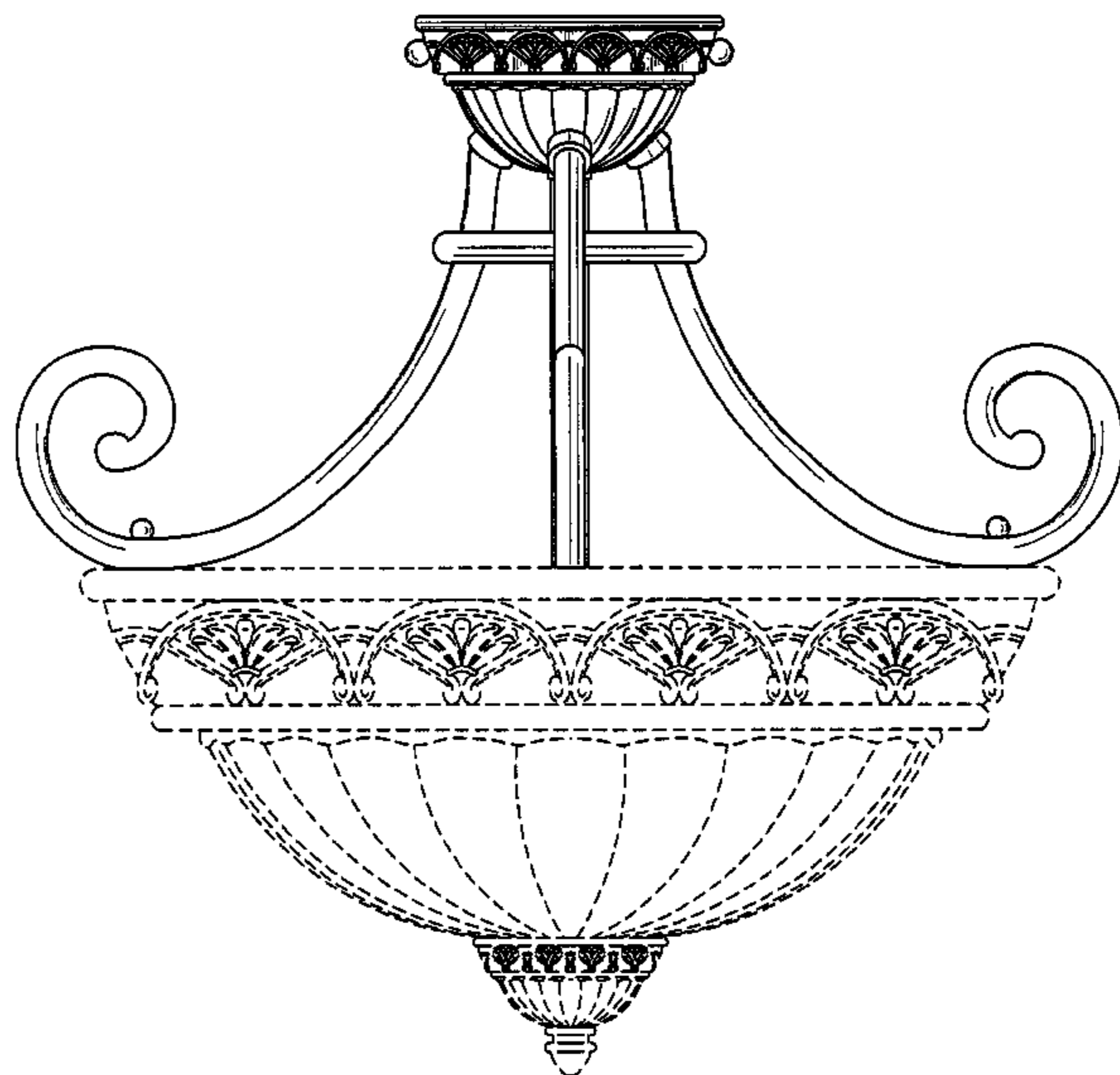
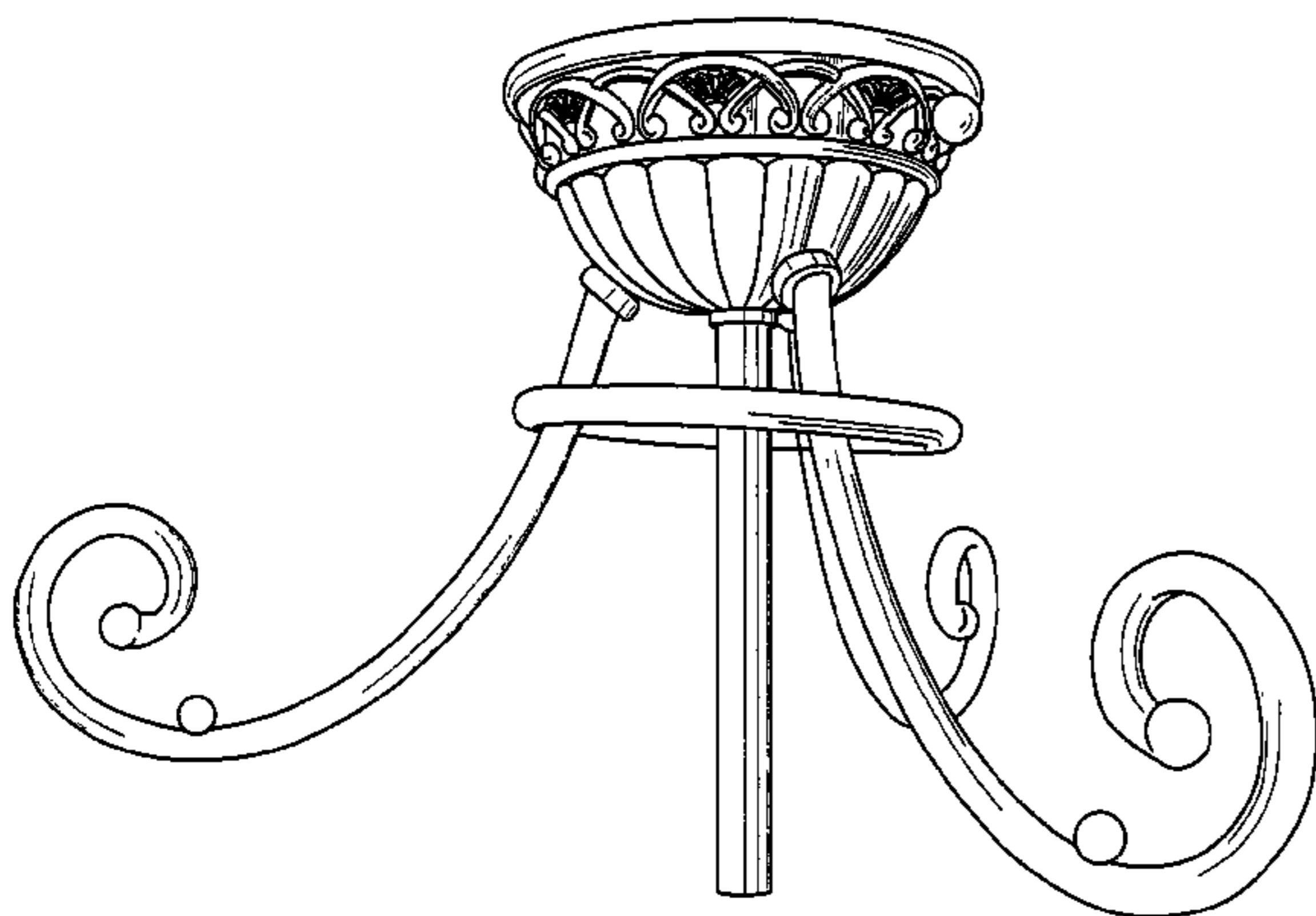

*FIG. 1*

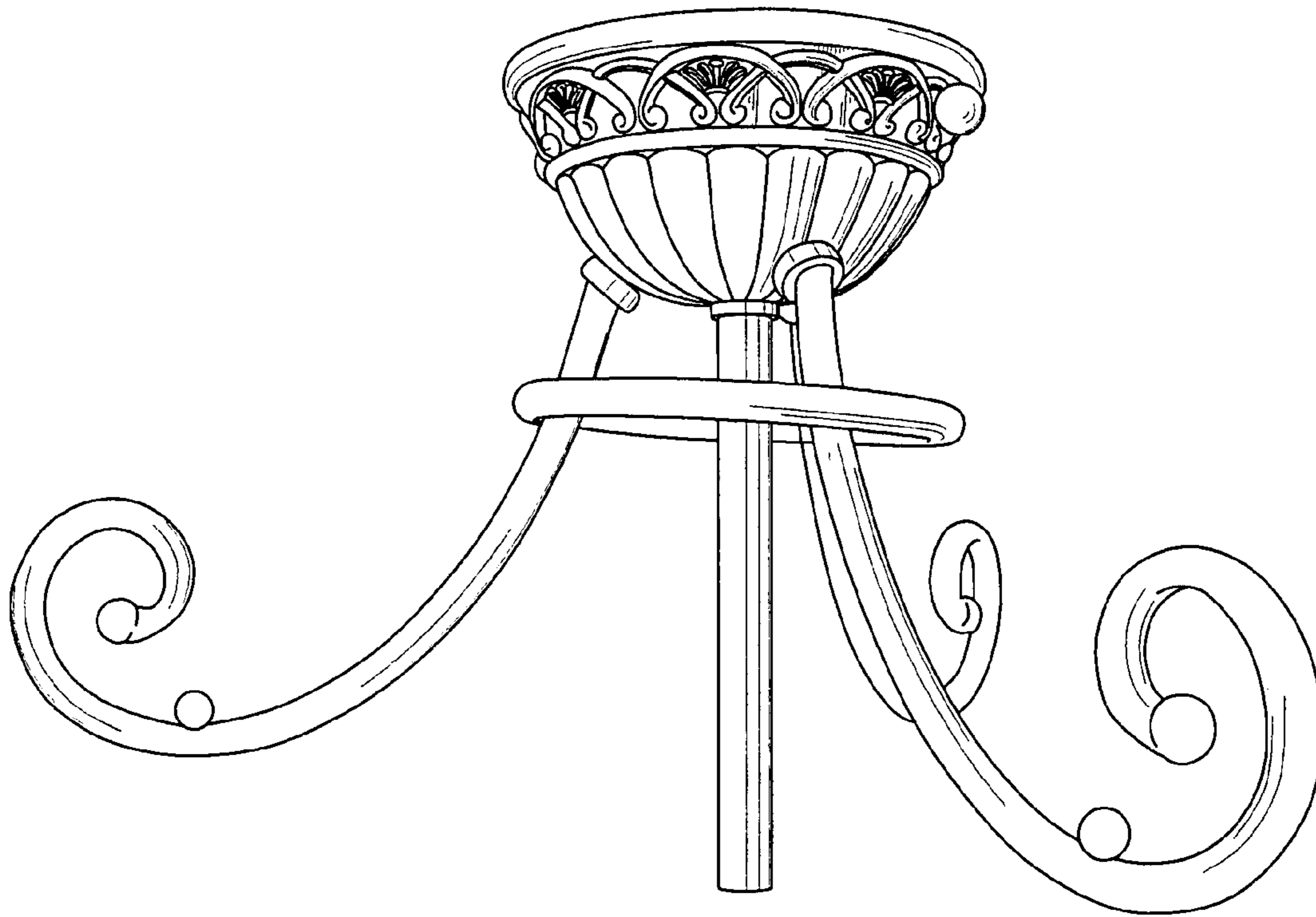
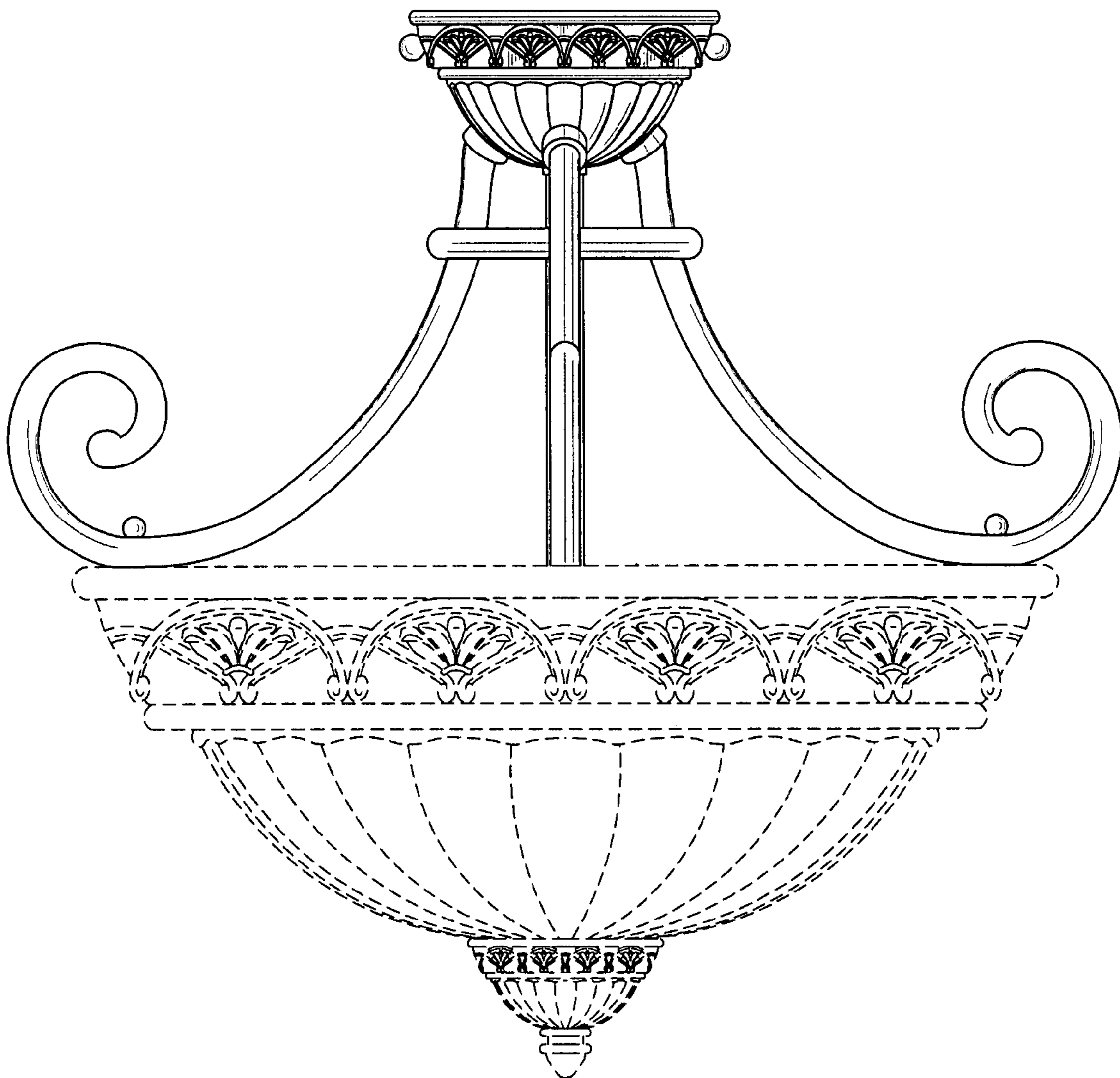
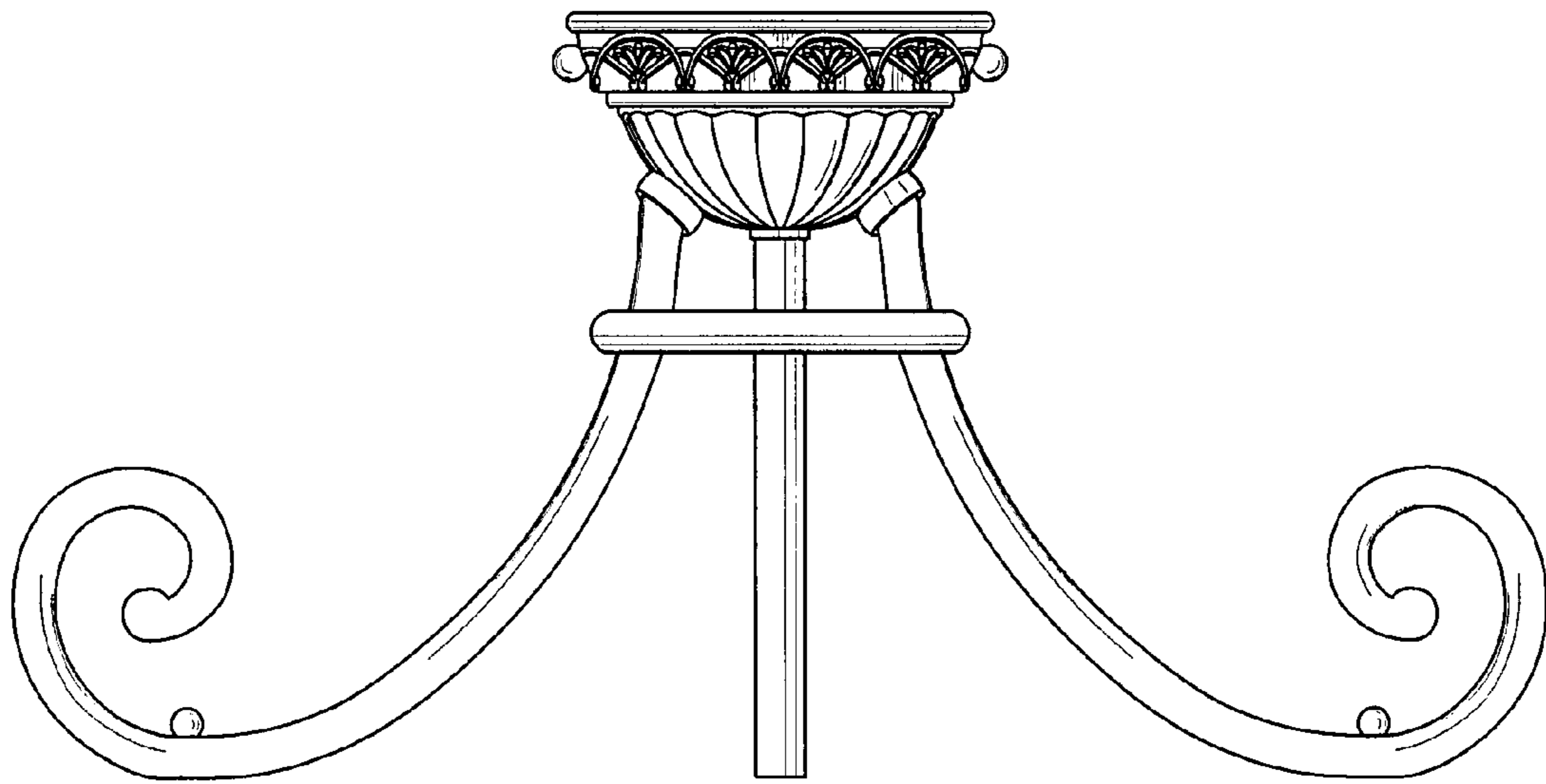

FIG. 2



*FIG. 3*



*FIG. 4*

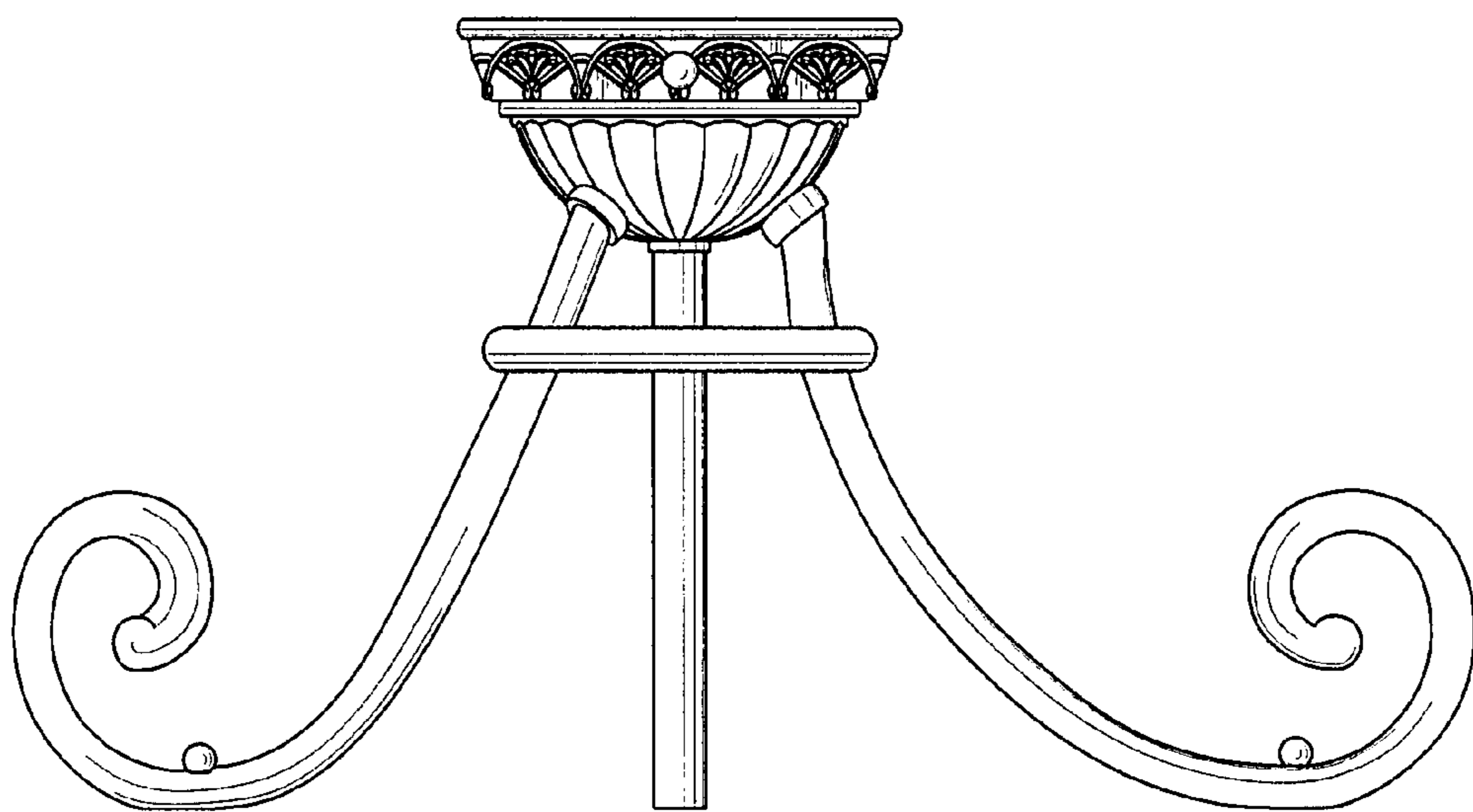

*FIG. 5*

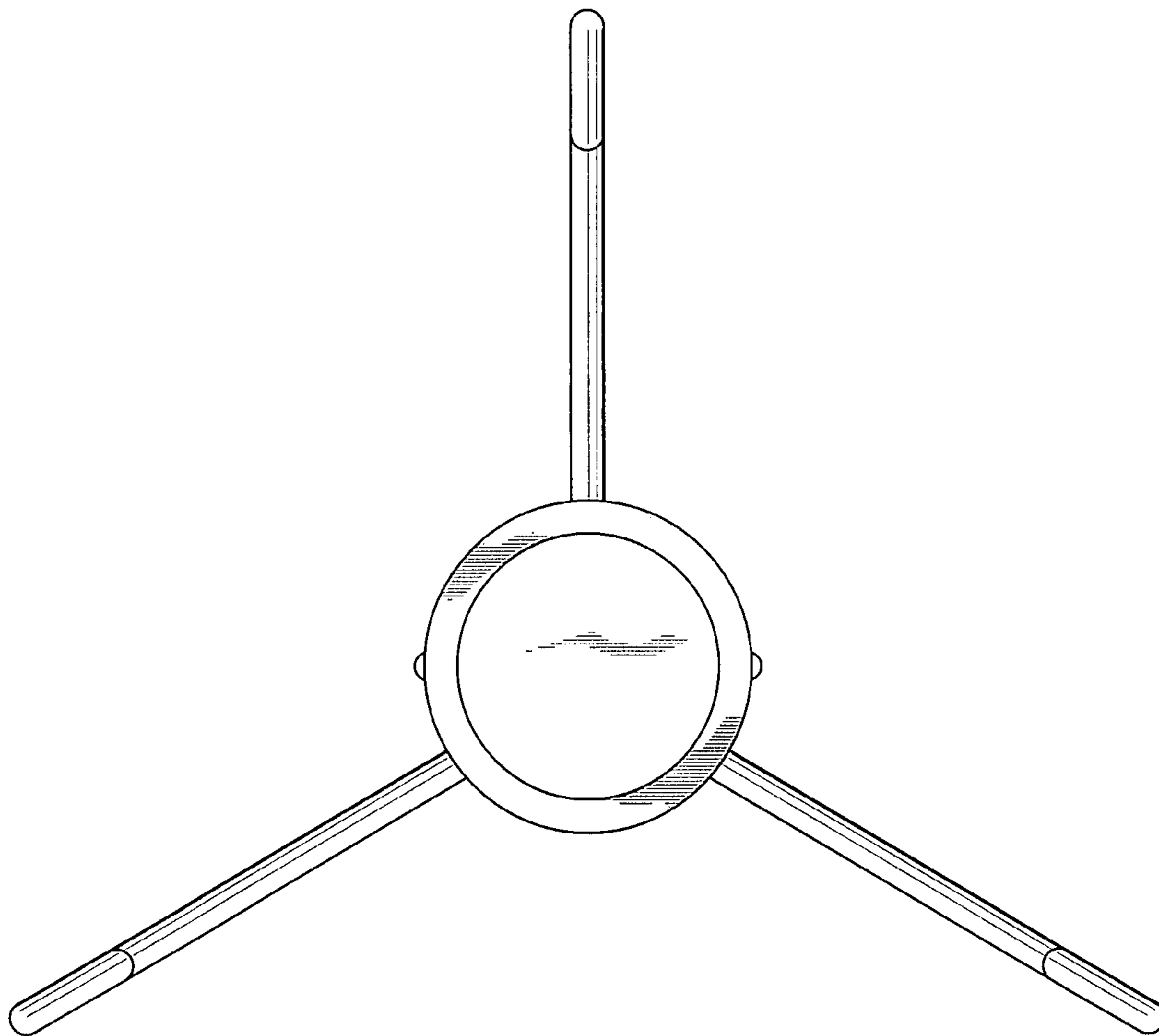

*FIG. 6*

