



US00D556814S

(12) **United States Design Patent**  
**Serlenga**

(10) **Patent No.:** **US D556,814 S**

(45) **Date of Patent:** **\*\* Dec. 4, 2007**

(54) **EYEWEAR**

(75) Inventor: **Sonja Serlenga**, St. Georgen (AT)

(73) Assignee: **Silhouette International Schmied AG**,  
Linz (AT)

(\*\*) Term: **14 Years**

(21) Appl. No.: **29/250,684**

(22) Filed: **Nov. 28, 2006**

(30) **Foreign Application Priority Data**

Jul. 10, 2006 (EM) ..... 000558275

(51) **LOC (8) Cl.** ..... **16-06**

(52) **U.S. Cl.** ..... **D16/314**; D16/321; D16/335

(58) **Field of Classification Search** ..... D16/300–330,  
D16/101, 332–338; D29/109–110; D24/110.2;  
351/41, 44, 51–52, 62, 158, 92, 103–111,  
351/156, 61, 114–119, 121–123; 2/426–432,  
2/447–449, 441, 434–437

See application file for complete search history.

(56) **References Cited**

**U.S. PATENT DOCUMENTS**

2,534,748 A \* 12/1950 Willson ..... 2/442  
2,574,896 A \* 11/1951 Tanis ..... 351/106  
3,685,889 A \* 8/1972 Thatcher ..... 351/44  
D275,574 S \* 9/1984 Feinbloom ..... D16/315

D294,951 S \* 3/1988 Shelton et al. .... D16/321  
D508,069 S 8/2005 Fuchs  
D508,940 S 8/2005 Fuchs  
D514,614 S \* 2/2006 Yang ..... D16/315  
D532,438 S \* 11/2006 Yang ..... D16/321

**OTHER PUBLICATIONS**

U.S. Appl. No. 29/215,967, filed Oct. 27, 2004; In re: Fuchs; entitled  
*Eyeglasses*.

\* cited by examiner

*Primary Examiner*—Raphael Barkai

(74) *Attorney, Agent, or Firm*—Alston & Bird LLP

(57) **CLAIM**

The ornamental design for eyewear, as shown and described.

**DESCRIPTION**

FIG. 1 is a perspective view of eyewear showing my new design;

FIG. 2 is a top plan view thereof;

FIG. 3 is a bottom plan view thereof;

FIG. 4 is a left side elevation view thereof;

FIG. 5 is a right side elevation view thereof;

FIG. 6 is a front elevation view thereof; and,

FIG. 7 is a rear elevation view thereof.

**1 Claim, 6 Drawing Sheets**

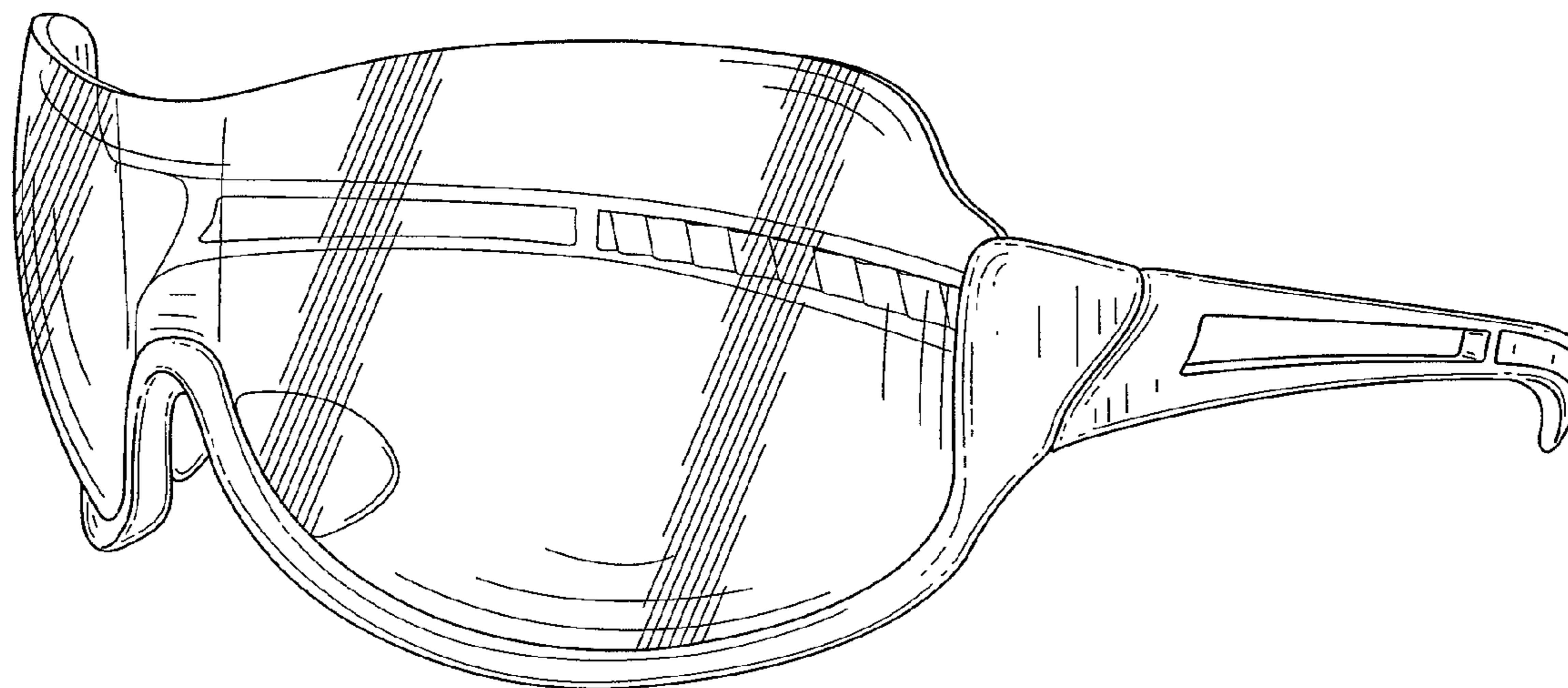

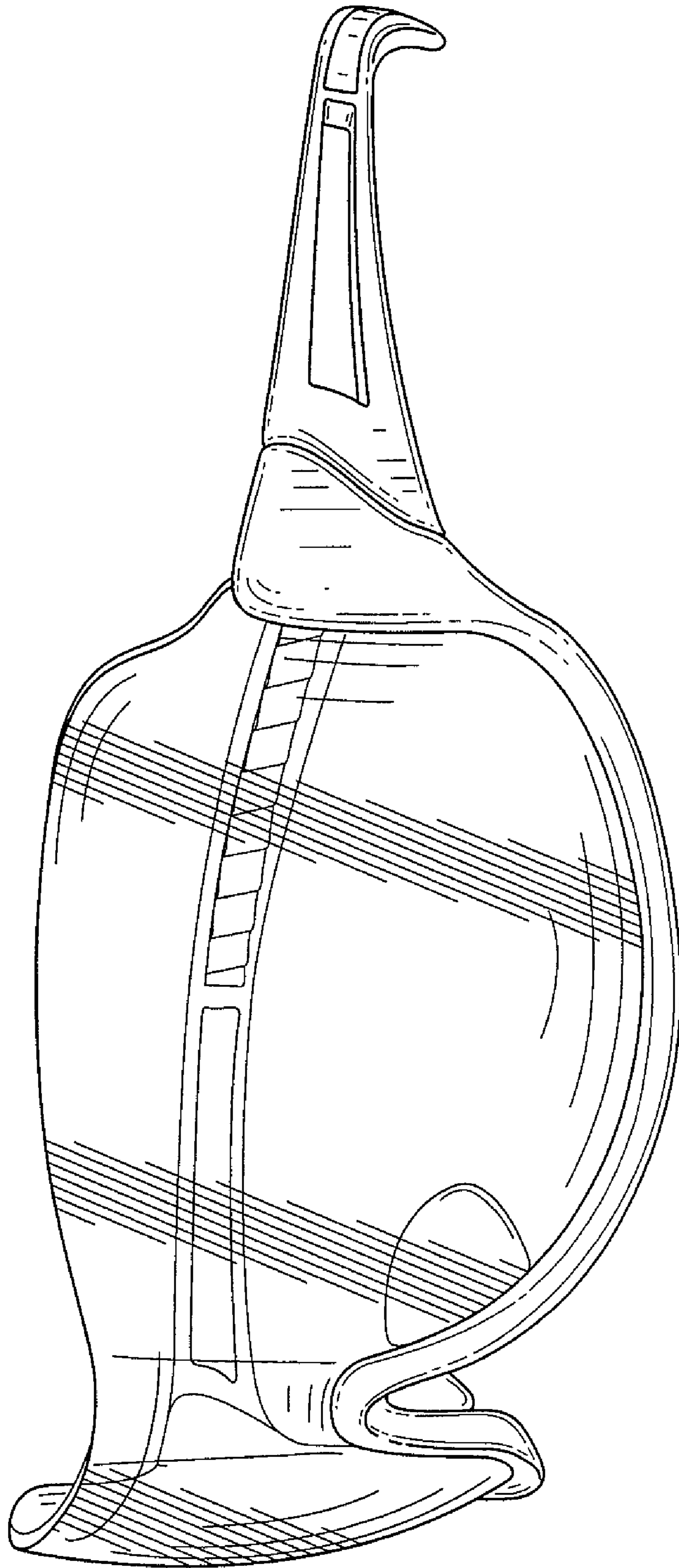

FIG. 1

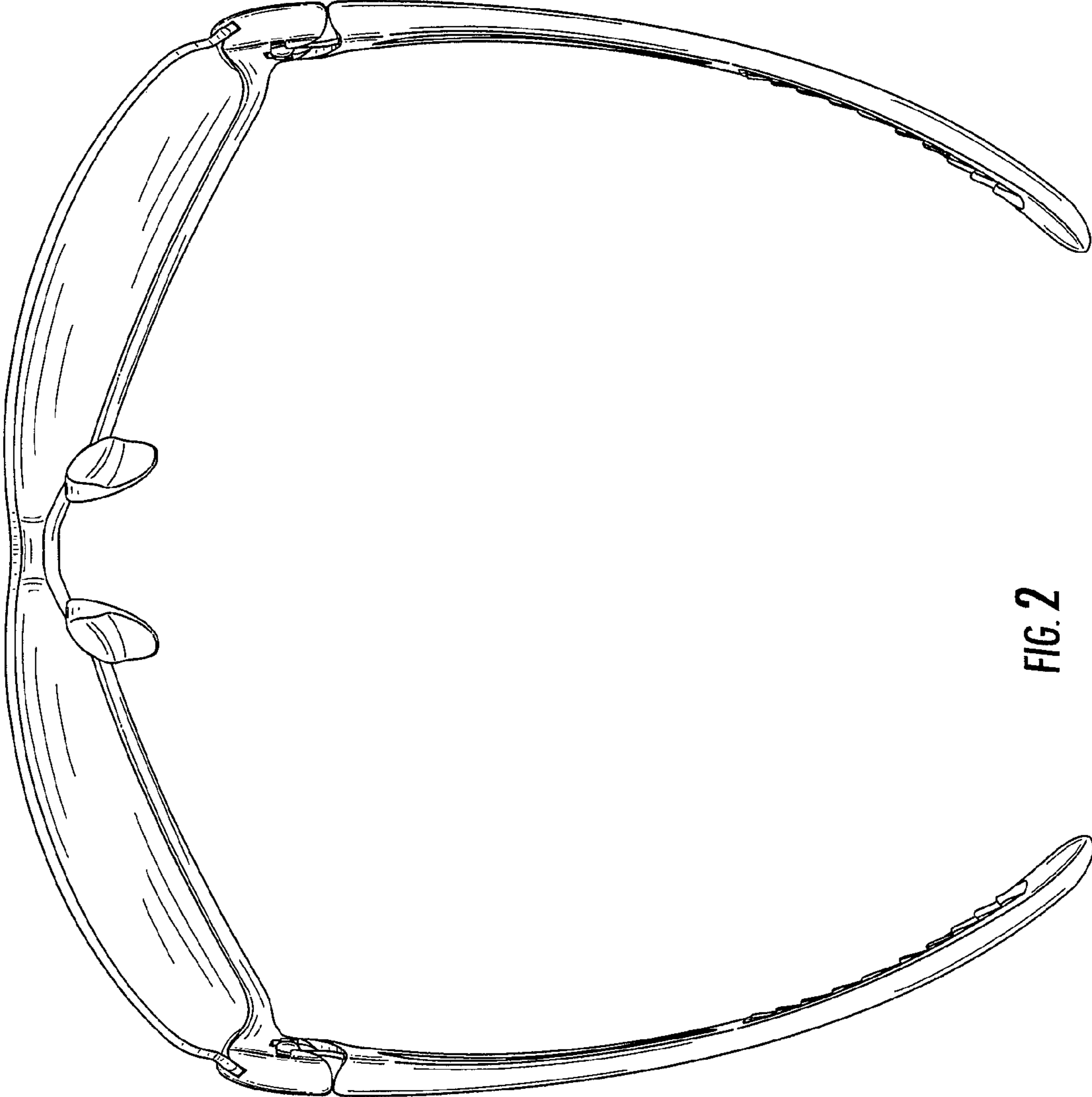

FIG. 2

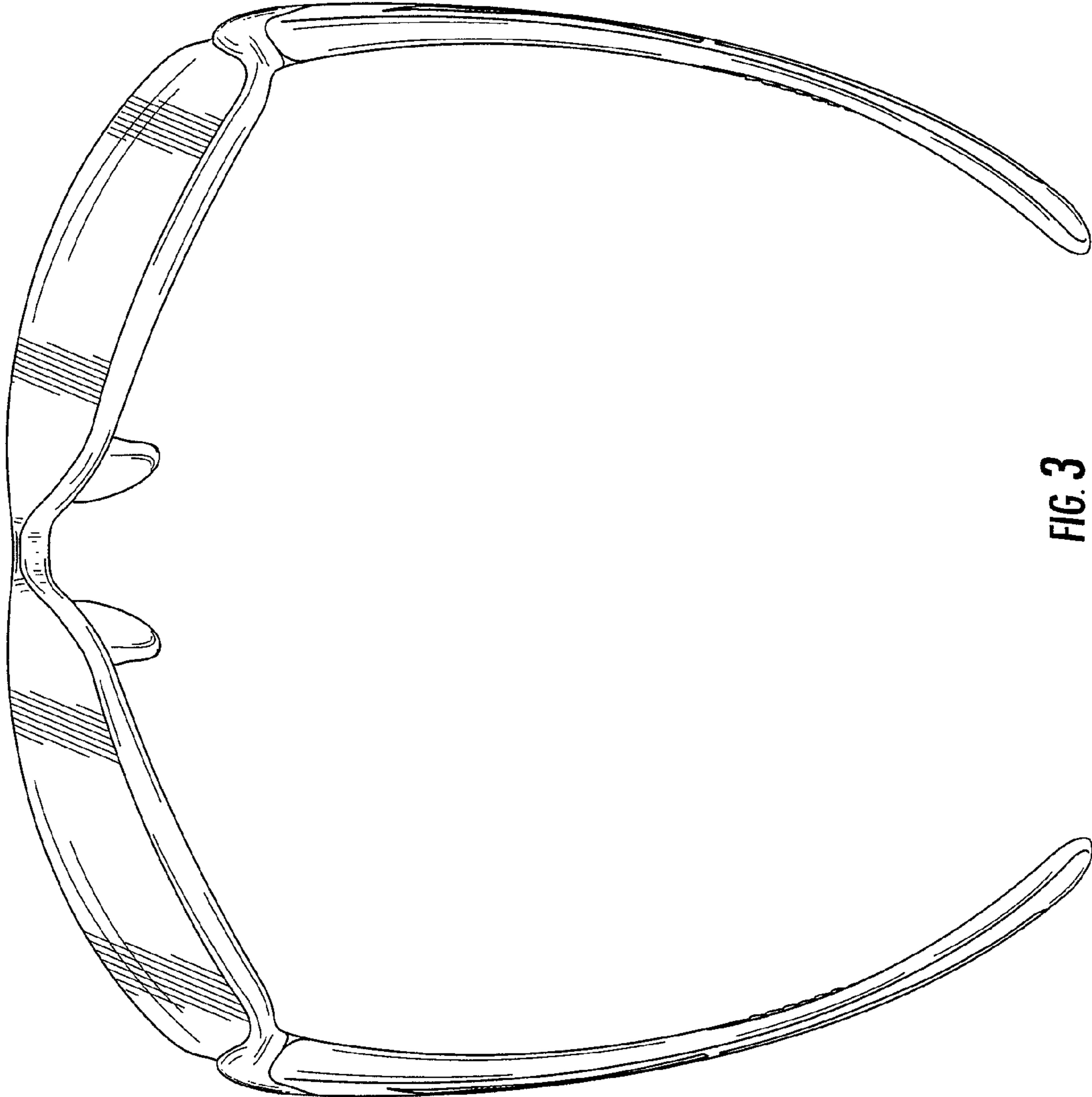

FIG. 3

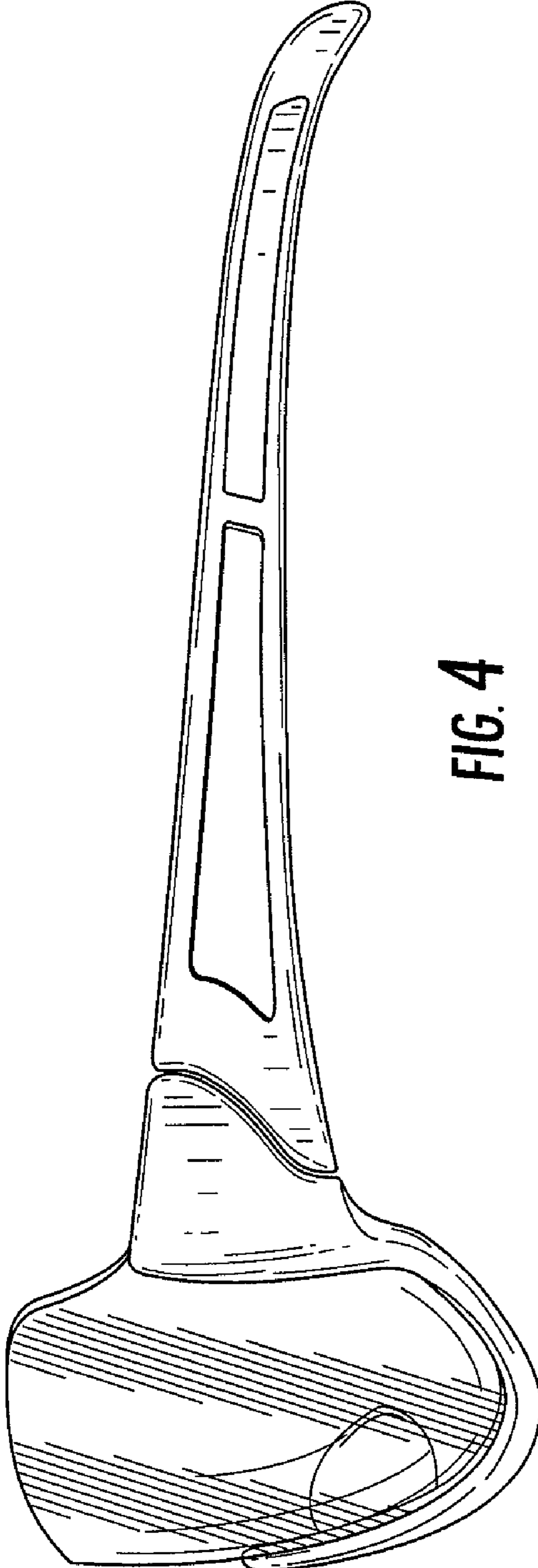

FIG. 4

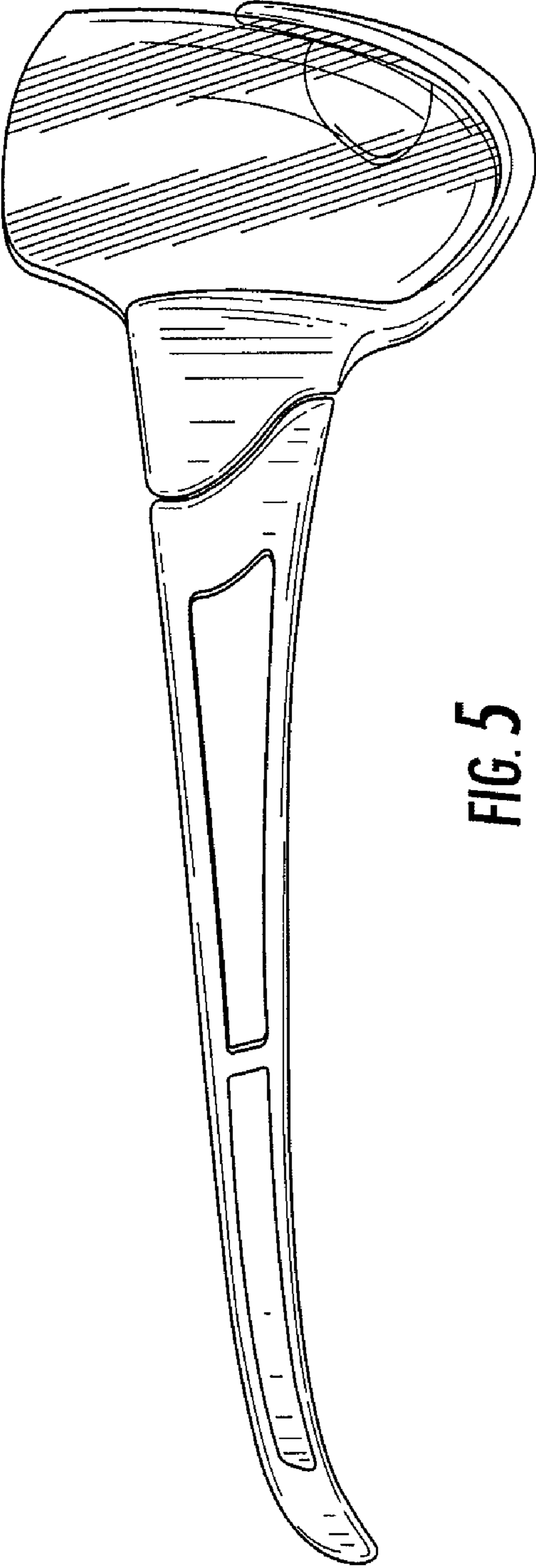
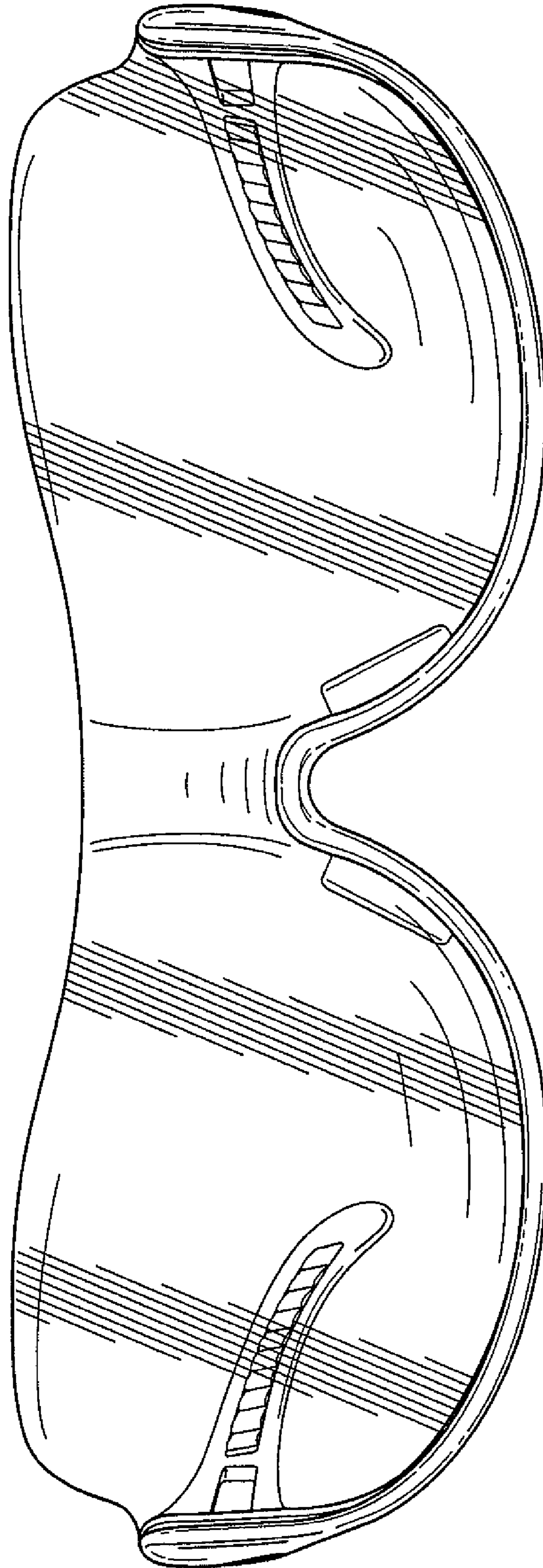

FIG. 5





**FIG. 6**

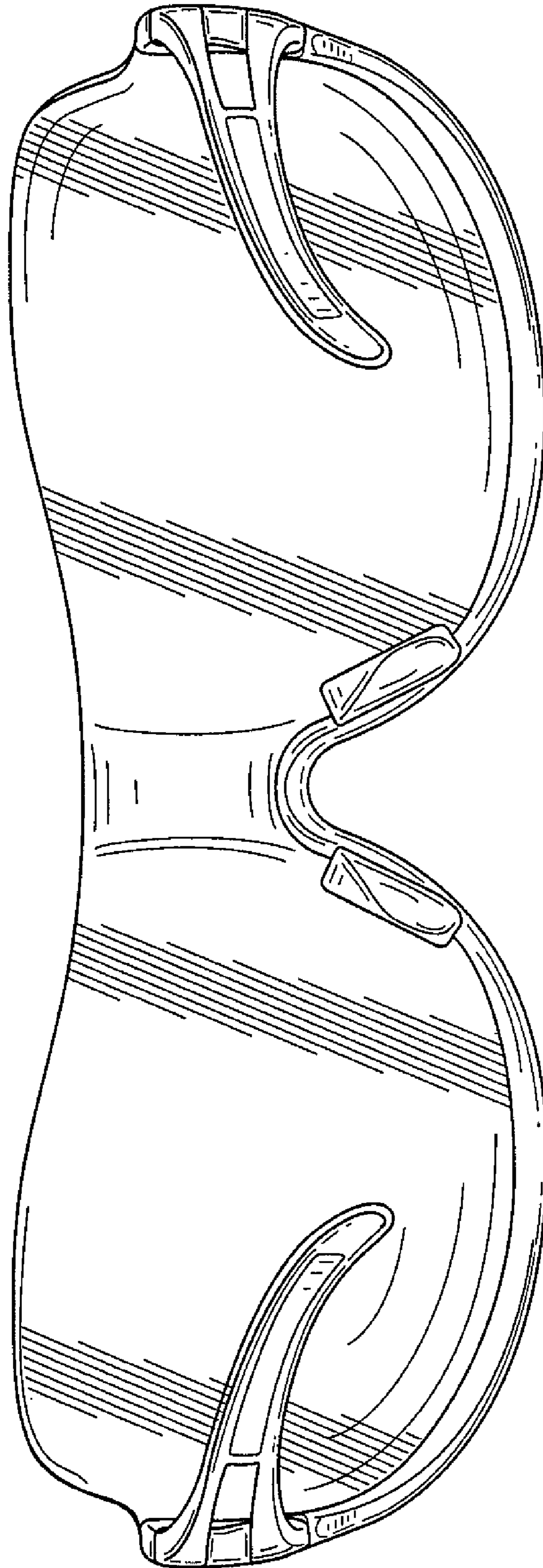

FIG. 7