



US00D556517S

(12) **United States Design Patent**
Lown et al.

(10) **Patent No.:** **US D556,517 S**
(45) **Date of Patent:** **** Dec. 4, 2007**

(54) **COMBINED AIRTIGHT LID AND CONTAINER**

Primary Examiner—Terry A Wallace
(74) *Attorney, Agent, or Firm*—Harold L. Jackson

(75) Inventors: **John M. Lown**, Huntington Beach, CA (US); **Ralph R. Hickman**, Orlando, FL (US); **Joie L. Puckett**, Long Beach, CA (US); **Richard K. Jung**, Laguna Niguel, CA (US)

(57) **CLAIM**

The ornamental design for a combined airtight lid and container, as shown and described.

(73) Assignee: **Snapware Corporation**, Mira Loma, CA (US)

DESCRIPTION

(**) Term: **14 Years**

FIG. 1 is a perspective view of the combined airtight lid and container for storing food and other items in accordance with the present invention, the stippling in FIGS. 1, 3, 5 and 7–10 representing a textured or frosted appearance;

(21) Appl. No.: **29/254,131**

FIG. 2 is a top plan view of the lid/container of FIG. 1;

(22) Filed: **Feb. 17, 2006**

FIG. 3 is a bottom view of the lid/container of FIG. 1;

(51) **LOC (8) Cl.** **07-01**

FIG. 4 is a side elevational view of the lid/container of FIG. 1 with one of the lid latches in an up non-receiving position, the view of both sides being identical;

(52) **U.S. Cl.** **D7/629**

FIG. 5 is an unassembled perspective view of the lid/container of FIG. 1;

(58) **Field of Classification Search** D7/601, D7/602, 629, 538–542; D3/272–274, 302, D3/201, 203, 205, 206; D9/420, 423, 424, D9/425, 430–432; 220/324, 326, 780–799, 220/574, 574.1

FIG. 6 is a side elevational view of the lid per se with both latches in an up position;

See application file for complete search history.

FIG. 7 is an additional top plan view of the lid/container of FIG. 1 positioned on the same sheet with like lid/containers having different dimensions;

(56) **References Cited**

FIGS. 8, 9 and 10 are top plan views of the lid/containers similar to the lid/containers of FIG. 1, but having different dimensions, the bottom views will be the same as FIG. 3 except for the dimensions;

U.S. PATENT DOCUMENTS

D150,045 S * 6/1948 Zaikaner D7/629
D282,808 S * 3/1986 Daenen et al. D7/602

FIG. 11 is a front view of the lid/containers of FIGS. 8 and 9 looking from the left of the figure;

(Continued)

OTHER PUBLICATIONS

Digital photographs of two containers sold under the Lock & Lock name.

Digital photographs of two containers marketed under the Biokips and Xeonic names.

FIG. 12 is a side view of the lid/containers of FIGS. 8, 9 and 10, looking from the bottom of FIGS. 7 and 8 and from the left of FIG. 10; and,

FIG. 13 is a front view of the lid/containers of FIGS. 9 and 10 looking from the bottom.

1 Claim, 7 Drawing Sheets

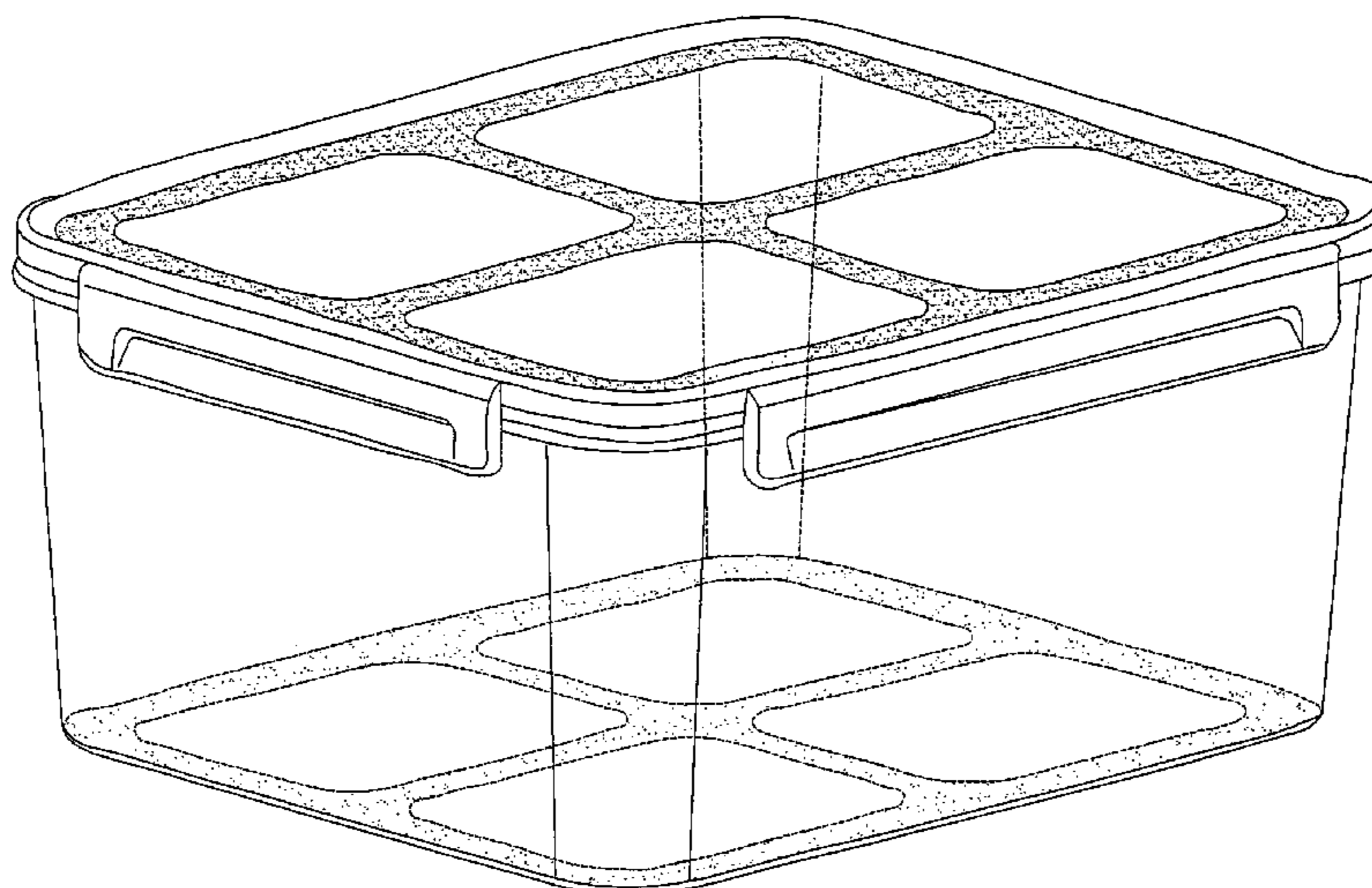

US D556,517 S

Page 2

U.S. PATENT DOCUMENTS

D302,774 S *	8/1989	Murphy	D7/629	D490,277 S *	5/2004	Kim	D7/629
4,976,370 A *	12/1990	Cassel	220/792	D493,073 S *	7/2004	Kim	D7/629
D452,374 S *	12/2001	Kim	D3/302	6,793,096 B1	9/2004	Seok		
D455,321 S *	4/2002	Jung et al.	D7/629	D500,227 S	12/2004	Seok		
D481,910 S *	11/2003	Kim	D7/629	2004/0084464 A1	5/2004	Koo		
D483,622 S *	12/2003	Kim	D7/629	2004/0099669 A1	5/2004	Lown et al.		
D484,367 S *	12/2003	Kim	D7/629	2005/0035125 A1	2/2005	Bae		

* cited by examiner

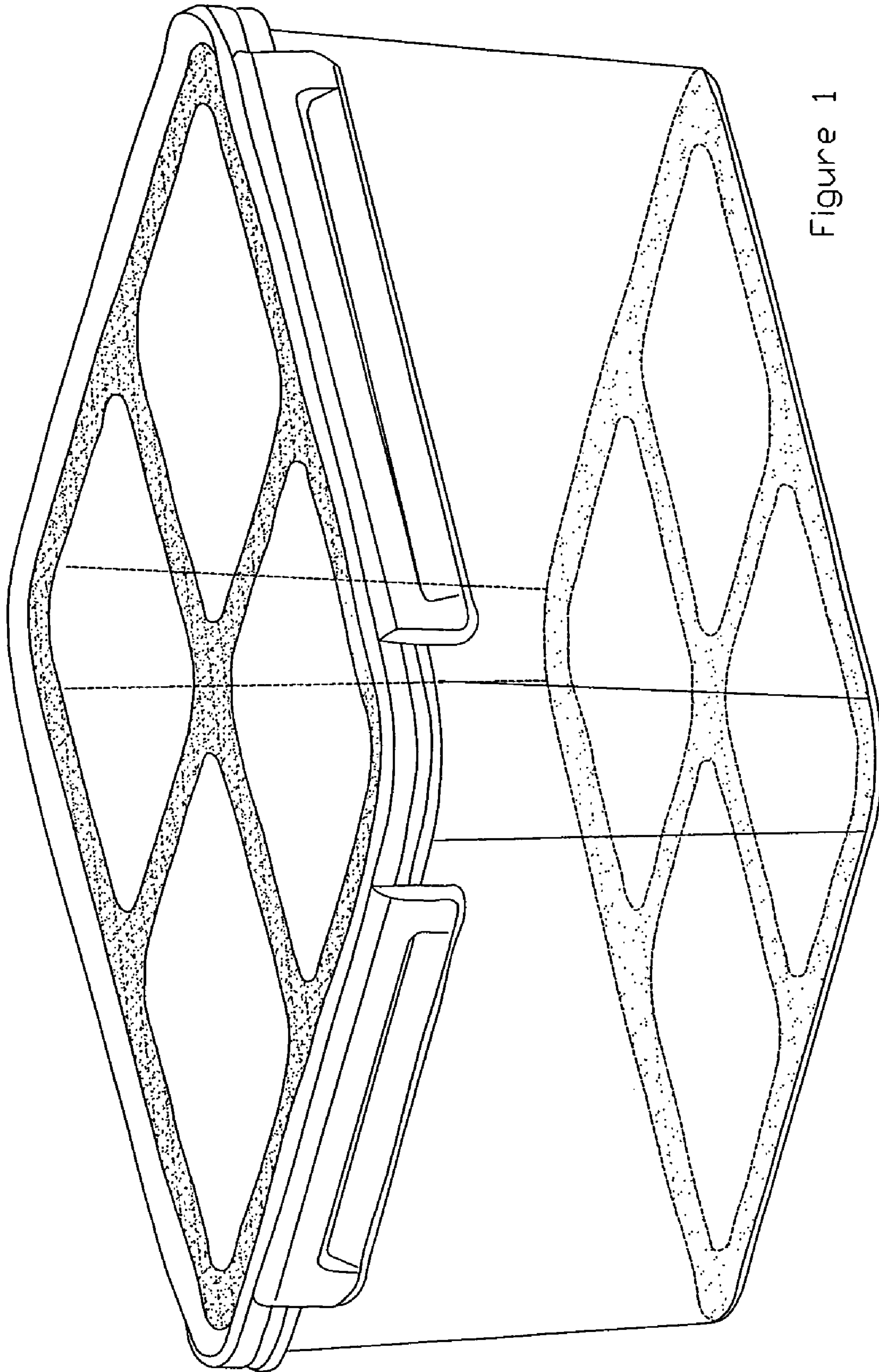

Figure 1

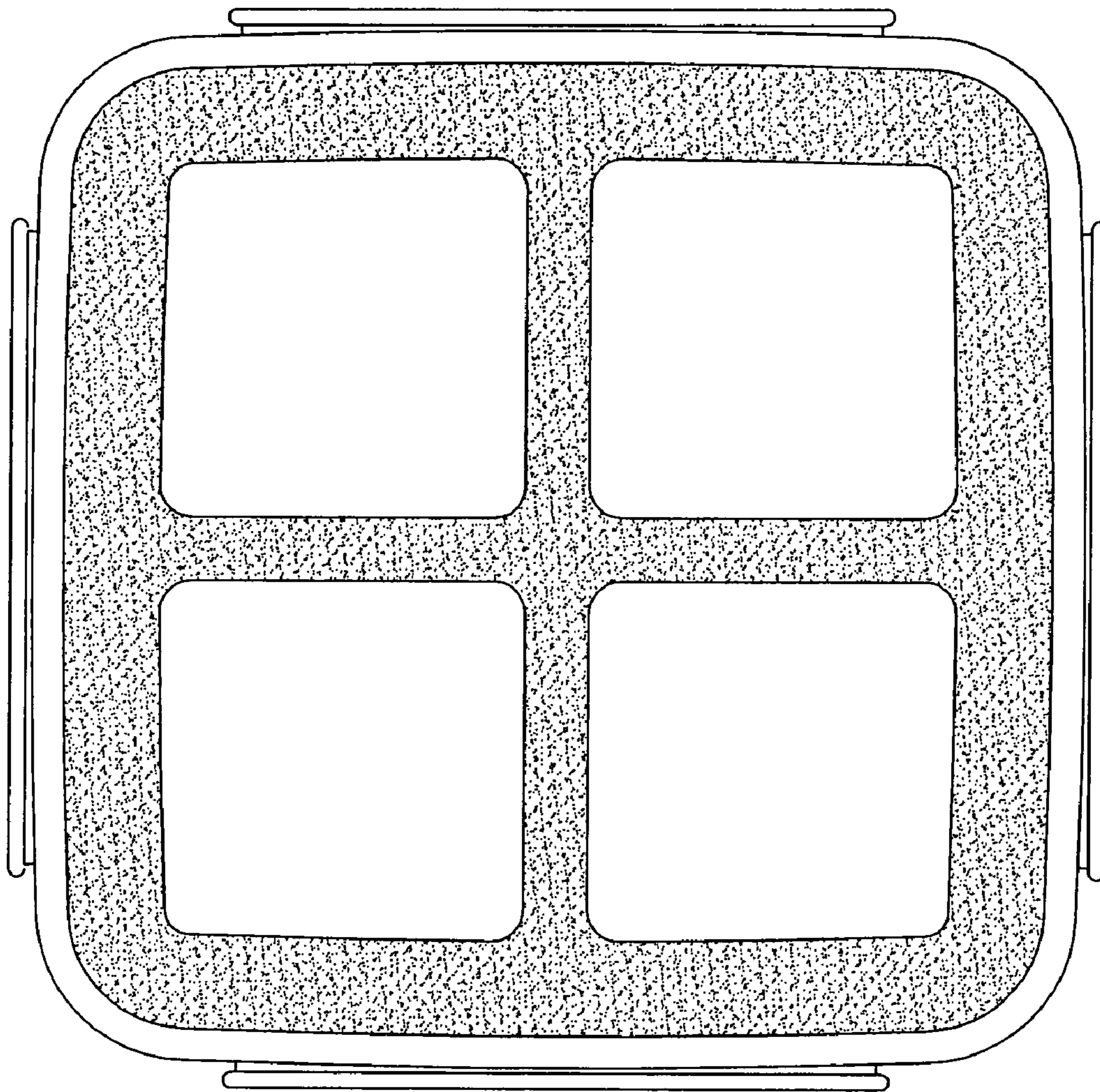

Figure 2

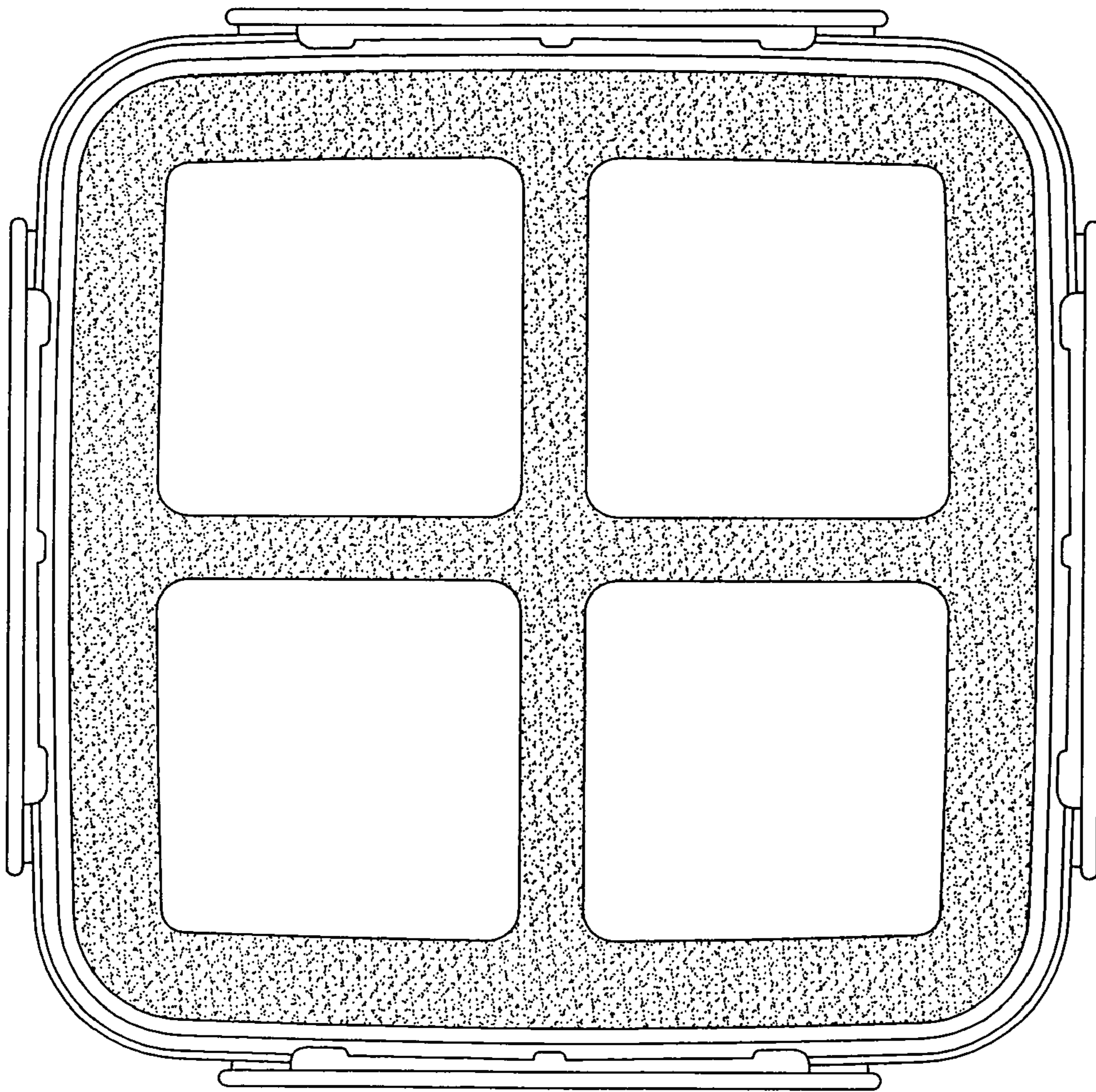

Figure 3

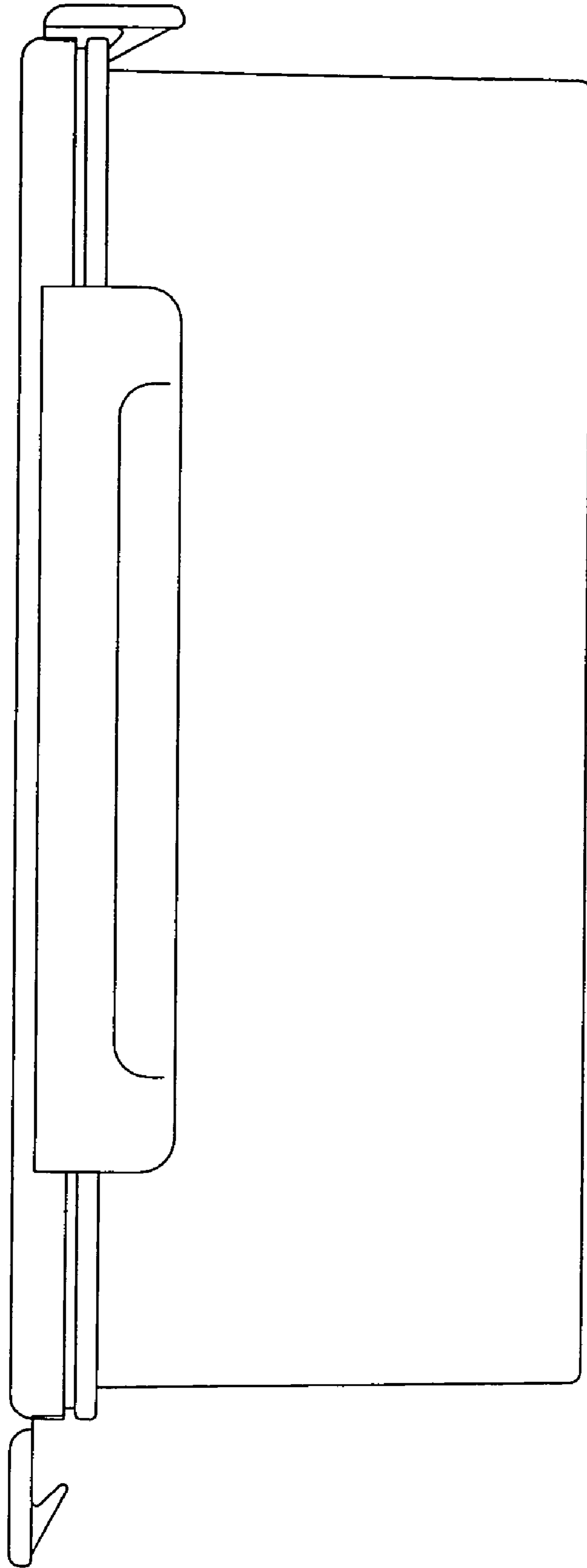

Figure 4

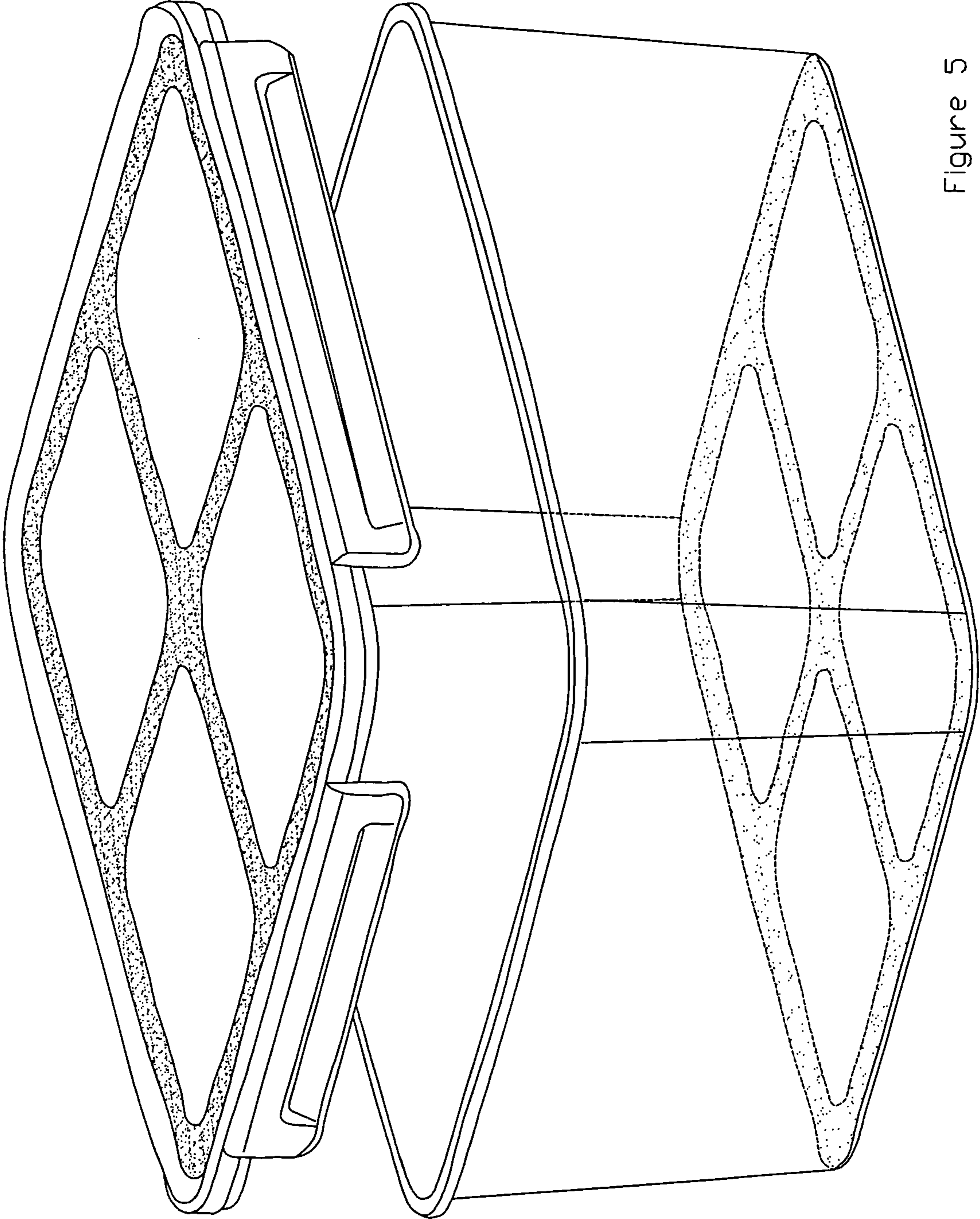

Figure 5

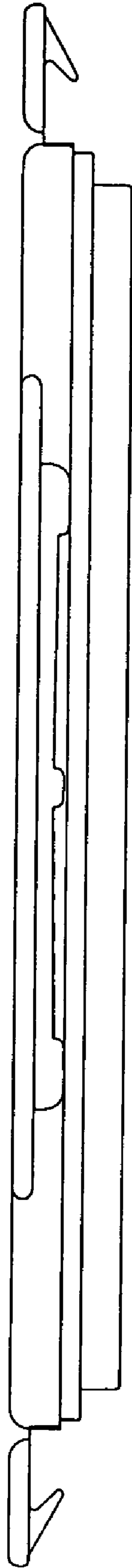

Figure 6

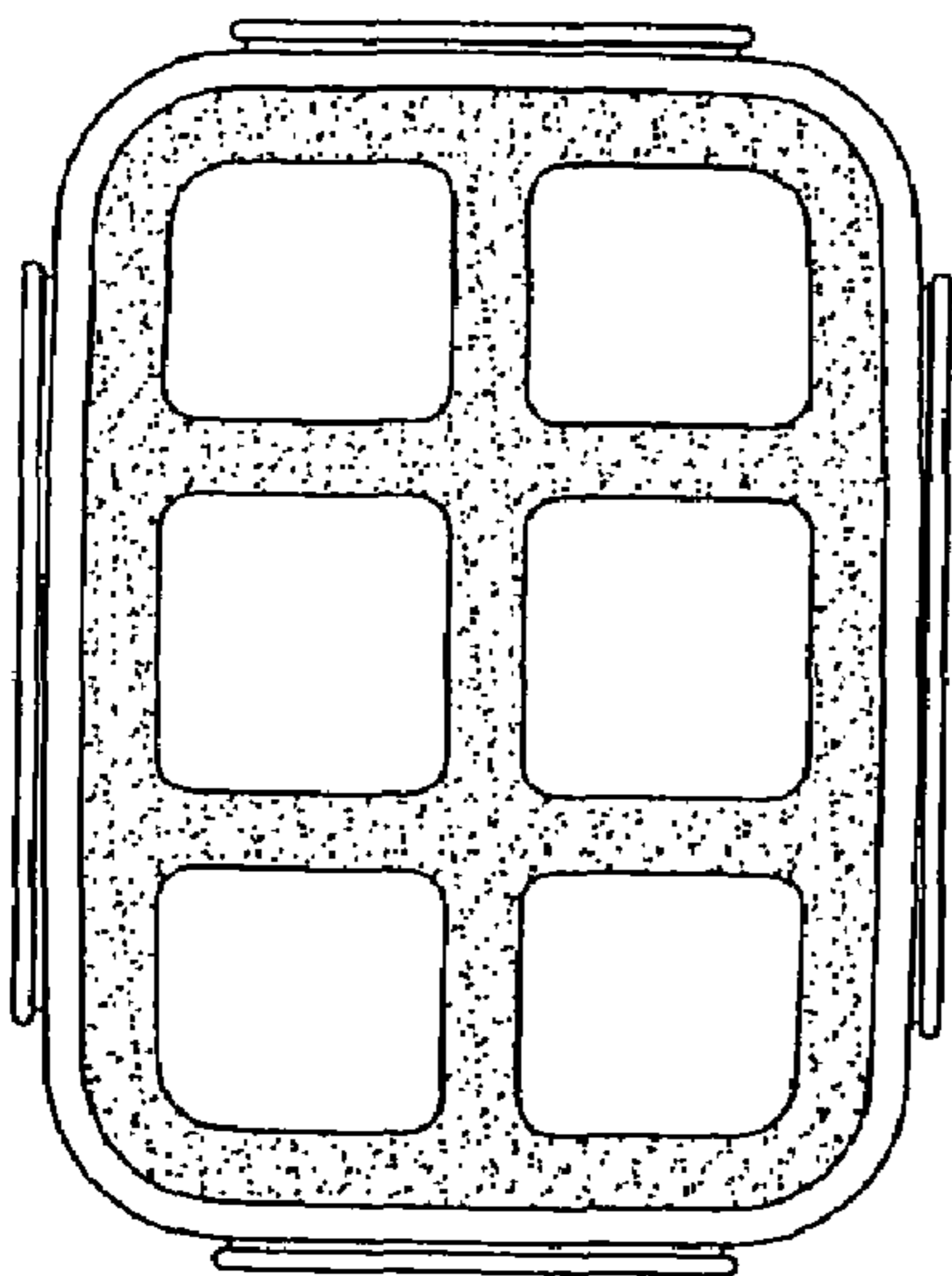

Figure 8

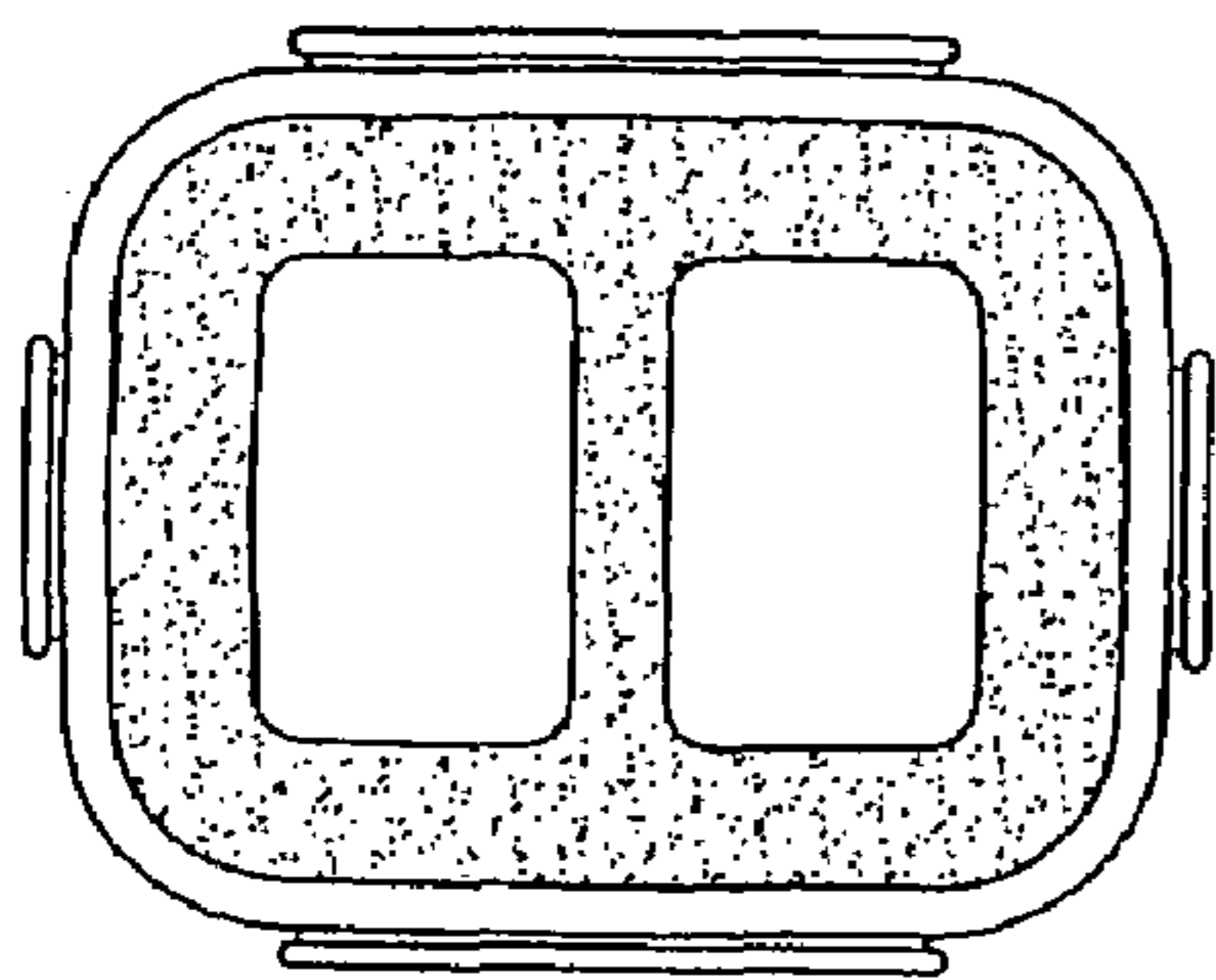

Figure 9

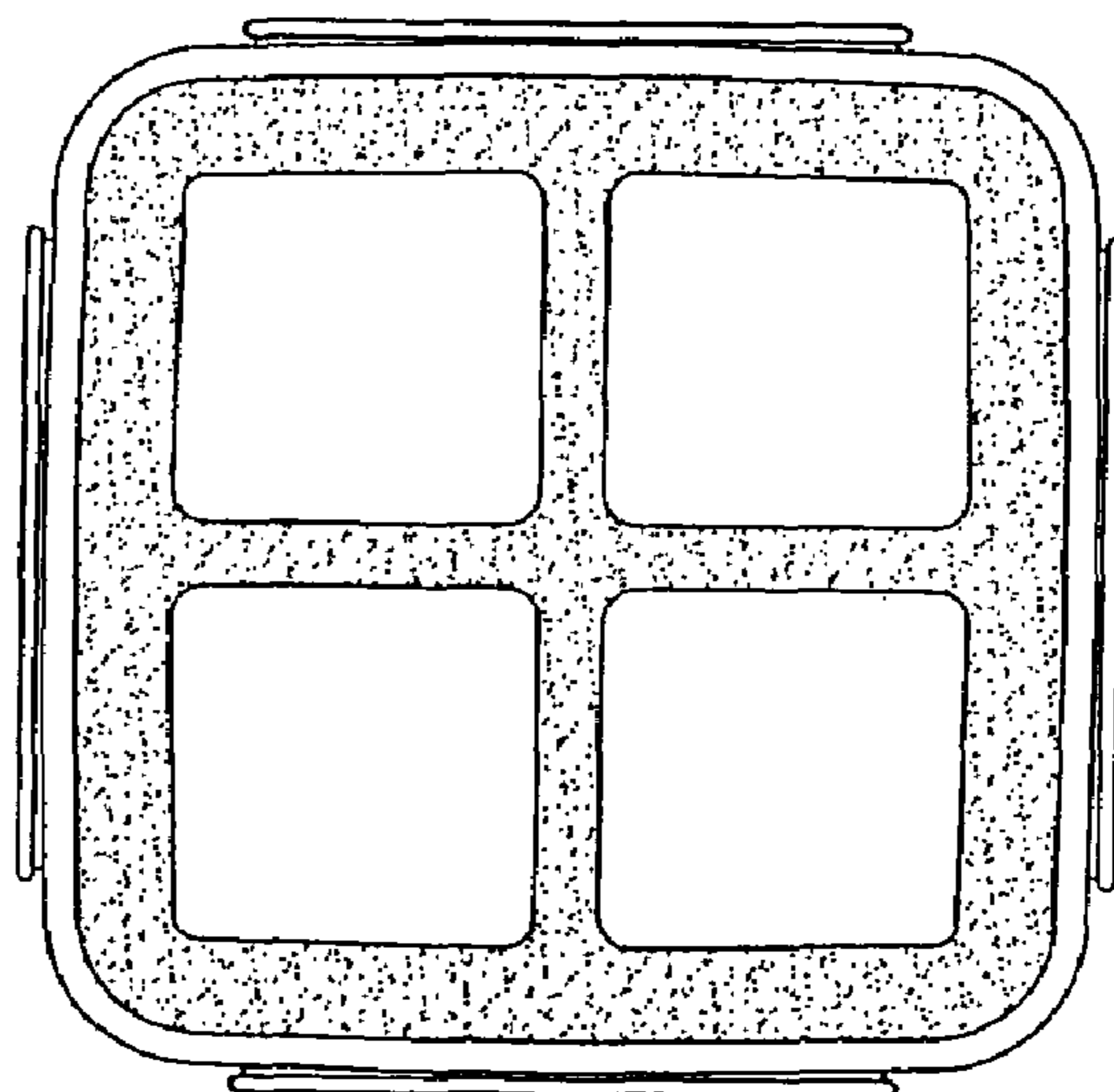

Figure 7

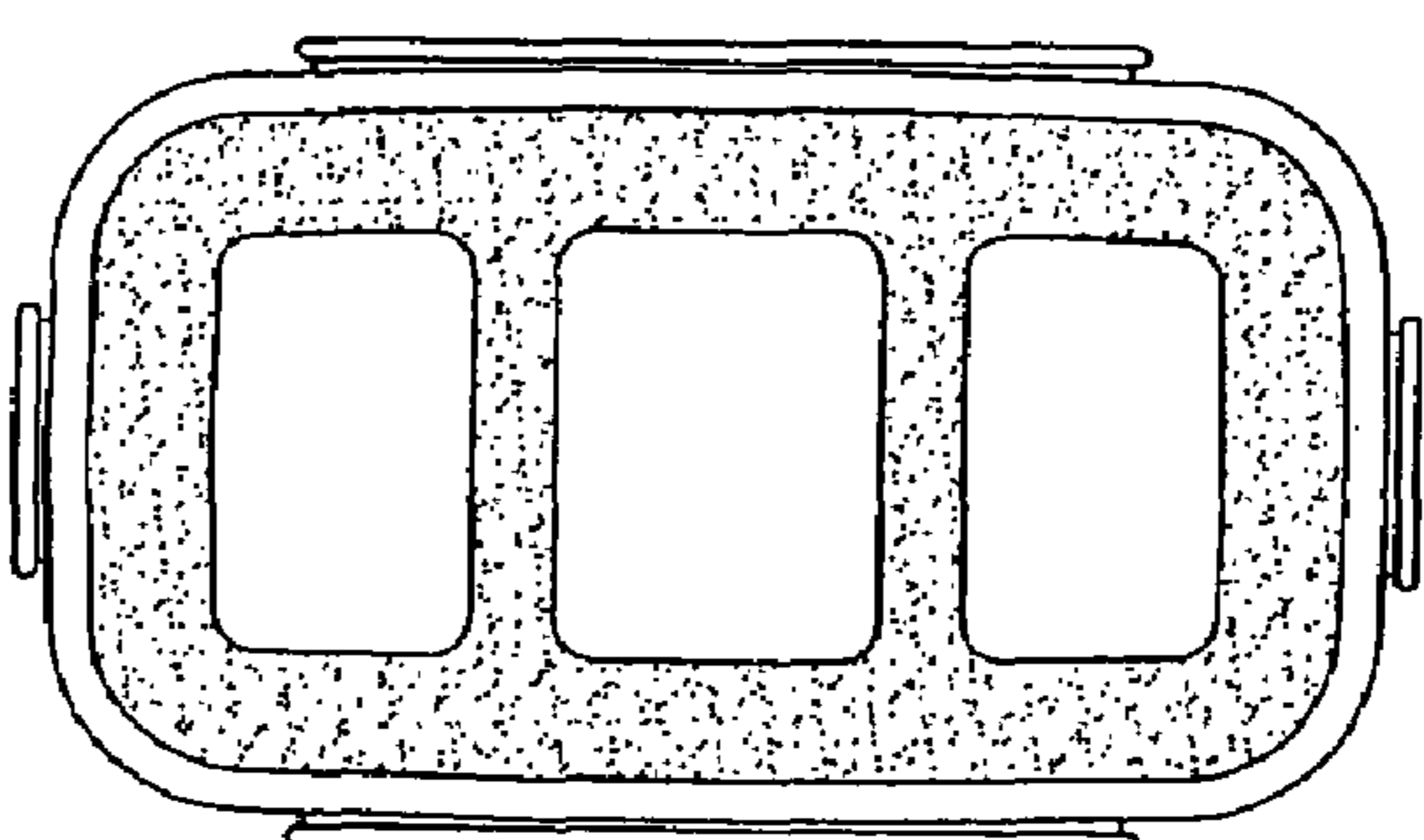

Figure 10

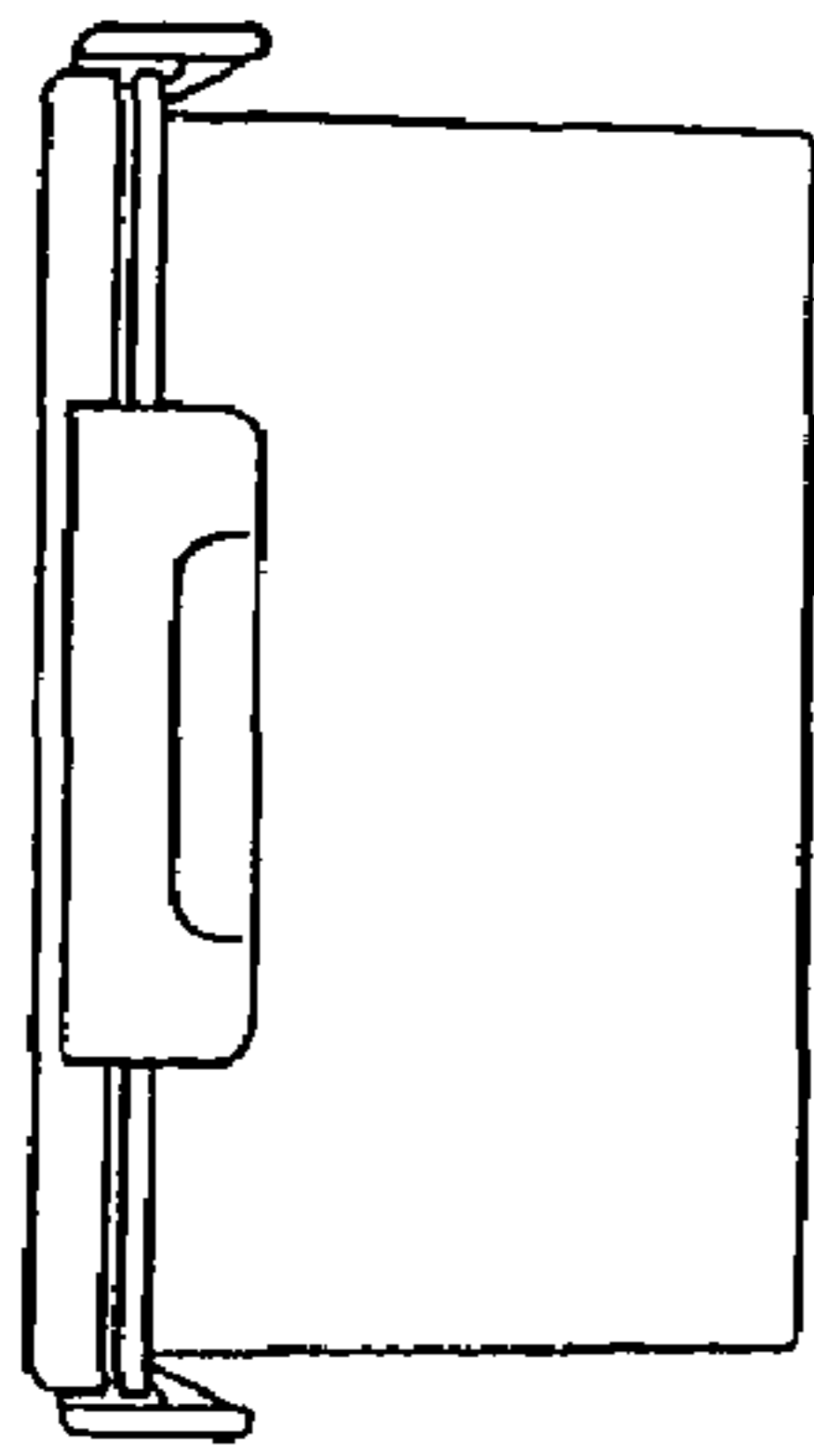

Figure 11

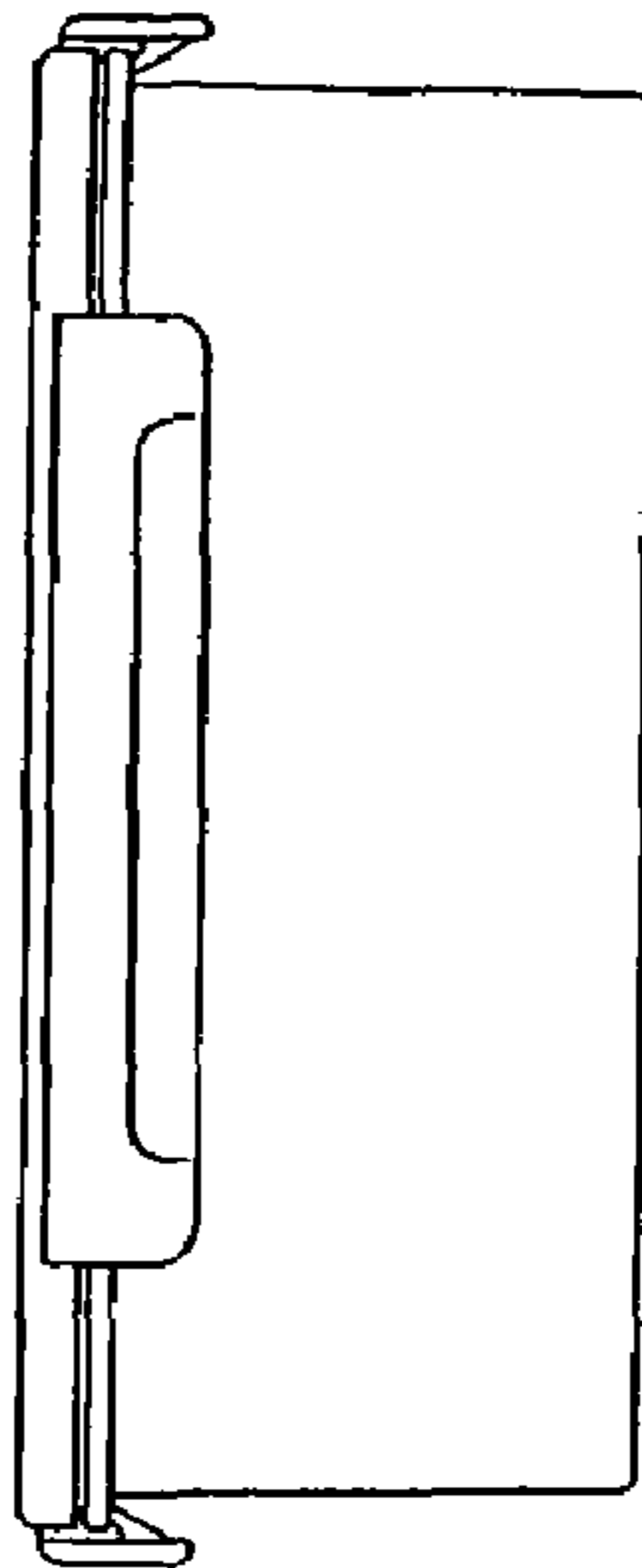

Figure 12

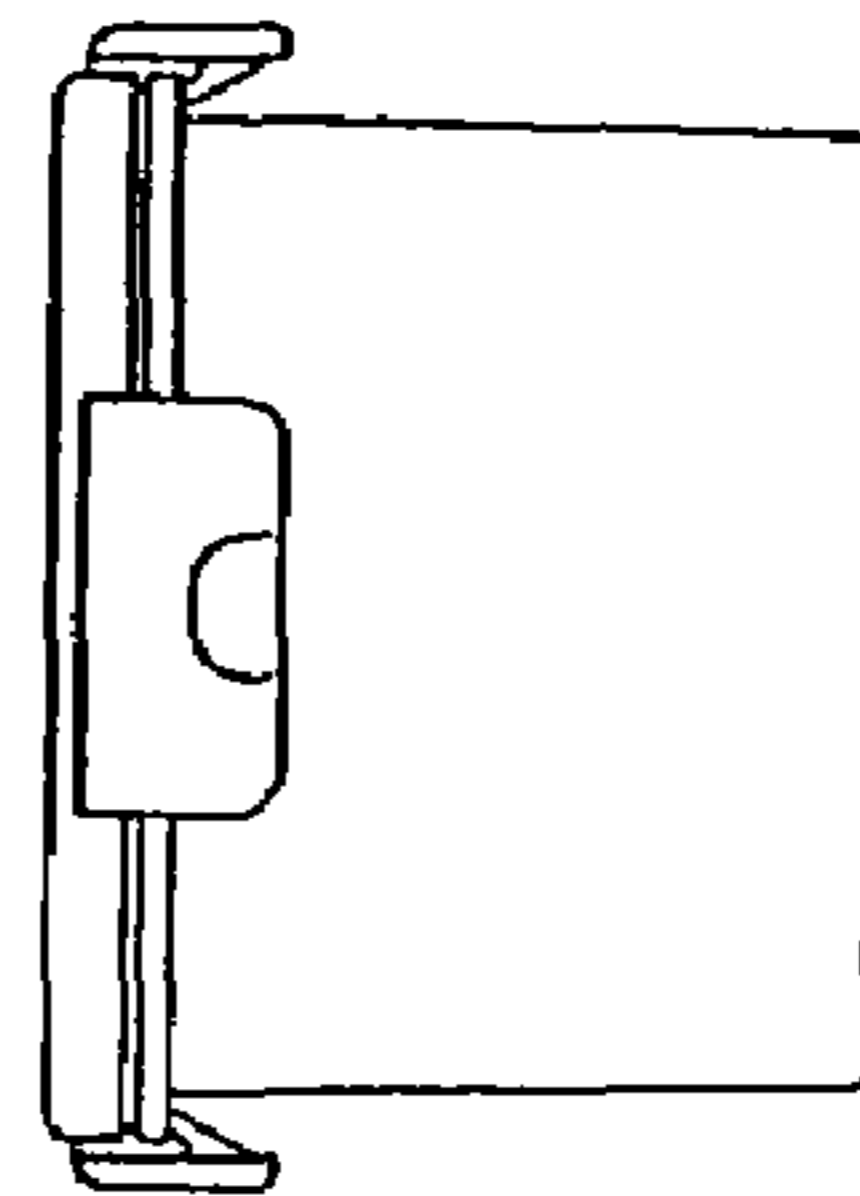

Figure 13