



US00D556509S

(12) **United States Design Patent**
Bonini

(10) **Patent No.:** **US D556,509 S**

(45) **Date of Patent:** **** Dec. 4, 2007**

(54) **SMOOTH WALLED MUG, LID AND HOLDER**

Primary Examiner—M. N. Pandozzi

(74) *Attorney, Agent, or Firm*—Lipsitz & McAllister, LLC

(75) Inventor: **Santina Bonini**, Mid Levels (HK)

(57) **CLAIM**

(73) Assignee: **Premier Merchandises Limited**, Kwai Chung-New Territories (HK)

The ornamental design for a smooth walled mug, lid and holder, as shown and described.

(**) Term: **14 Years**

(21) Appl. No.: **29/230,958**

(22) Filed: **May 27, 2005**

(30) **Foreign Application Priority Data**

Feb. 8, 2005 (HK) 0500295.9M001

(51) **LOC (8) Cl.** **07-01**

(52) **U.S. Cl.** **D7/507; D7/532; D7/510**

(58) **Field of Classification Search** D7/505,
D7/624.1, 507, 509, 523, 532, 510, 511; 219/432;
206/217; 215/387; 220/62.12, 703, 217
See application file for complete search history.

(56) **References Cited**

U.S. PATENT DOCUMENTS

D19,162 S *	6/1889	King	D7/523
D47,798 S *	9/1915	Pick	D7/523
D47,799 S *	9/1915	Pick	D7/523
D105,430 S *	7/1937	Boehm	D7/532
D105,943 S *	9/1937	Fuerst	D7/523
D228,721 S *	10/1973	Todd	D7/624.1
4,040,549 A *	8/1977	Sadler	224/483
4,224,764 A *	9/1980	Dziewulski et al.	47/71
D333,756 S *	3/1993	Campbell	D7/507
5,531,353 A *	7/1996	Ward et al.	220/729
D375,659 S *	11/1996	Lipic	D7/624.1
D376,728 S *	12/1996	Richards et al.	D7/507
D434,273 S *	11/2000	Johansen et al.	D7/396.6
D460,661 S *	7/2002	Norris et al.	D7/533
D460,895 S *	7/2002	Lin	D7/533
6,450,363 B1 *	9/2002	Lin	220/758

(Continued)

DESCRIPTION

FIG. 1 is a top front perspective view of a smooth walled mug, lid, and holder showing my new design;

FIG. 2 is a front elevational view thereof;

FIG. 3 is a top plan view thereof;

FIG. 4 is a left side elevational view thereof;

FIG. 5 is a rear elevational view thereof;

FIG. 6 is a bottom plan view thereof;

FIG. 7 is an exploded left side elevational view thereof;

FIG. 8 is a side elevational view of the mug portion of the smooth walled mug, lid and holder with the lid and holder removed for ease of illustration;

FIG. 9 is a top plan view thereof;

FIG. 10 is a bottom plan view thereof;

FIG. 11 is a top plan view of the lid portion of the smooth walled mug, lid and holder with the mug and holder removed for ease of illustration;

FIG. 12 is a bottom plan view thereof;

FIG. 13 is a left side elevational view thereof;

FIG. 14 is a front elevational view thereof;

FIG. 15 is a rear elevational view thereof;

FIG. 16 is a top plan view of the holder portion of the smooth walled mug, lid, and holder with the mug and lid portion removed for ease of illustration;

FIG. 17 is a bottom plan view thereof; and,

FIG. 18 is a side elevational view thereof.

1 Claim, 9 Drawing Sheets

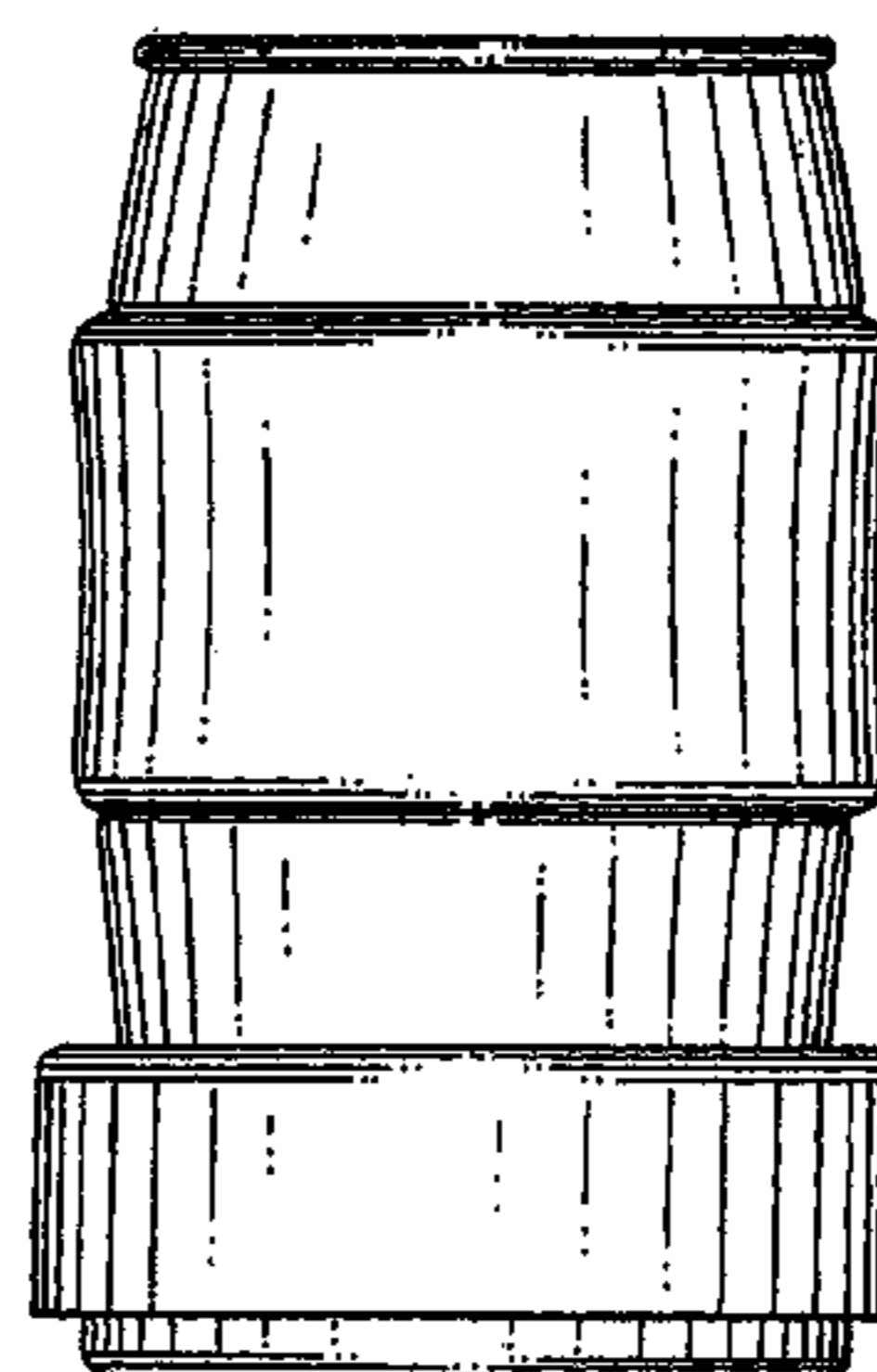
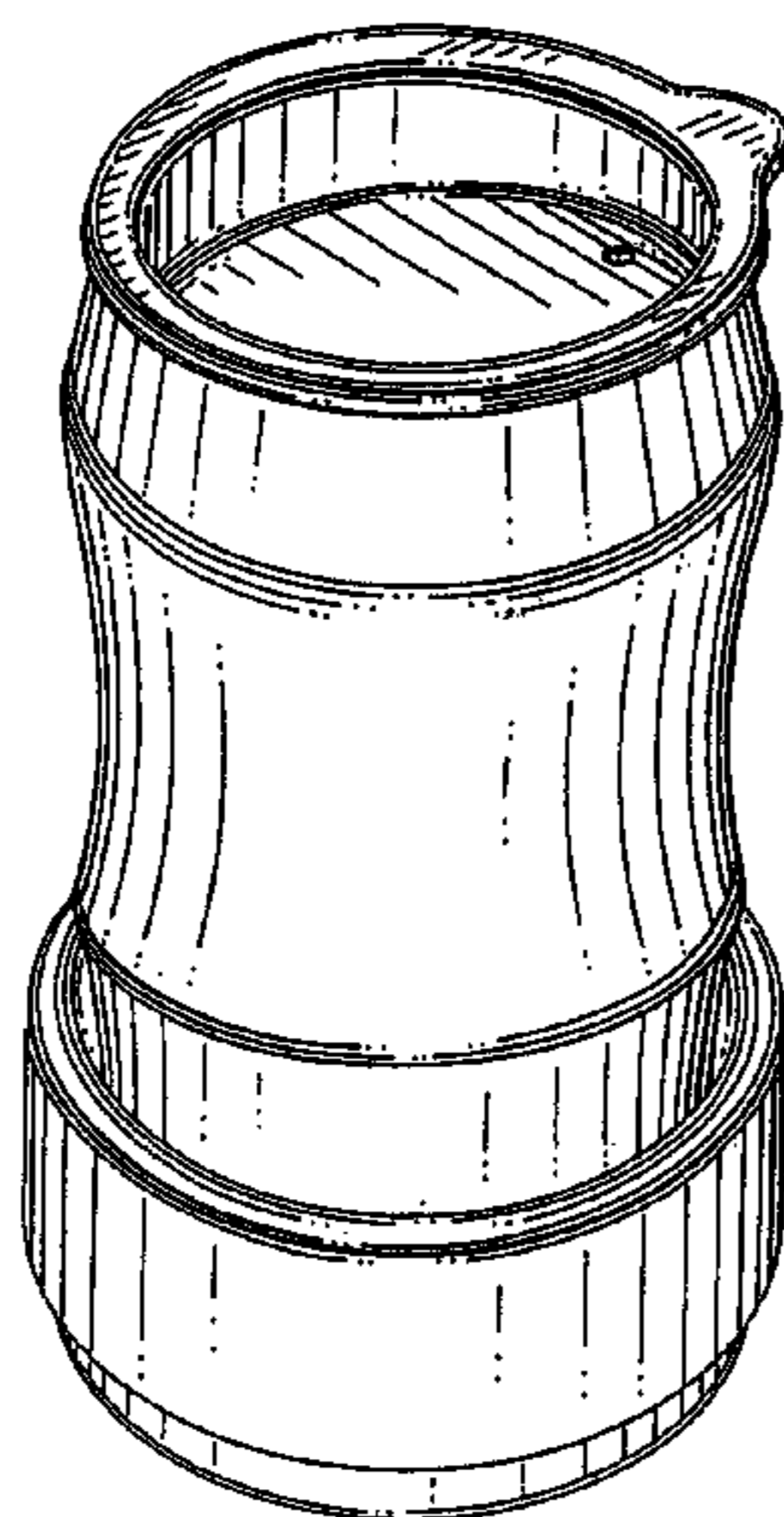

US D556,509 S

Page 2

U.S. PATENT DOCUMENTS

D464,849 S	*	10/2002	Norris et al.	D7/523	6,834,838 B2	*	12/2004	Dennis et al.	248/311.2
D466,371 S	*	12/2002	Parker	D7/510	D523,692 S	*	6/2006	Meehan	D7/507
D475,891 S	*	6/2003	Bin	D7/510	D530,980 S	*	10/2006	Zerillo et al.	D7/509
D476,528 S	*	7/2003	Janky et al.	D7/536	D531,856 S	*	11/2006	Seum et al.	D7/523
D497,079 S	*	10/2004	Paggio	D7/507	D534,038 S	*	12/2006	Kramer et al.	D7/510

* cited by examiner

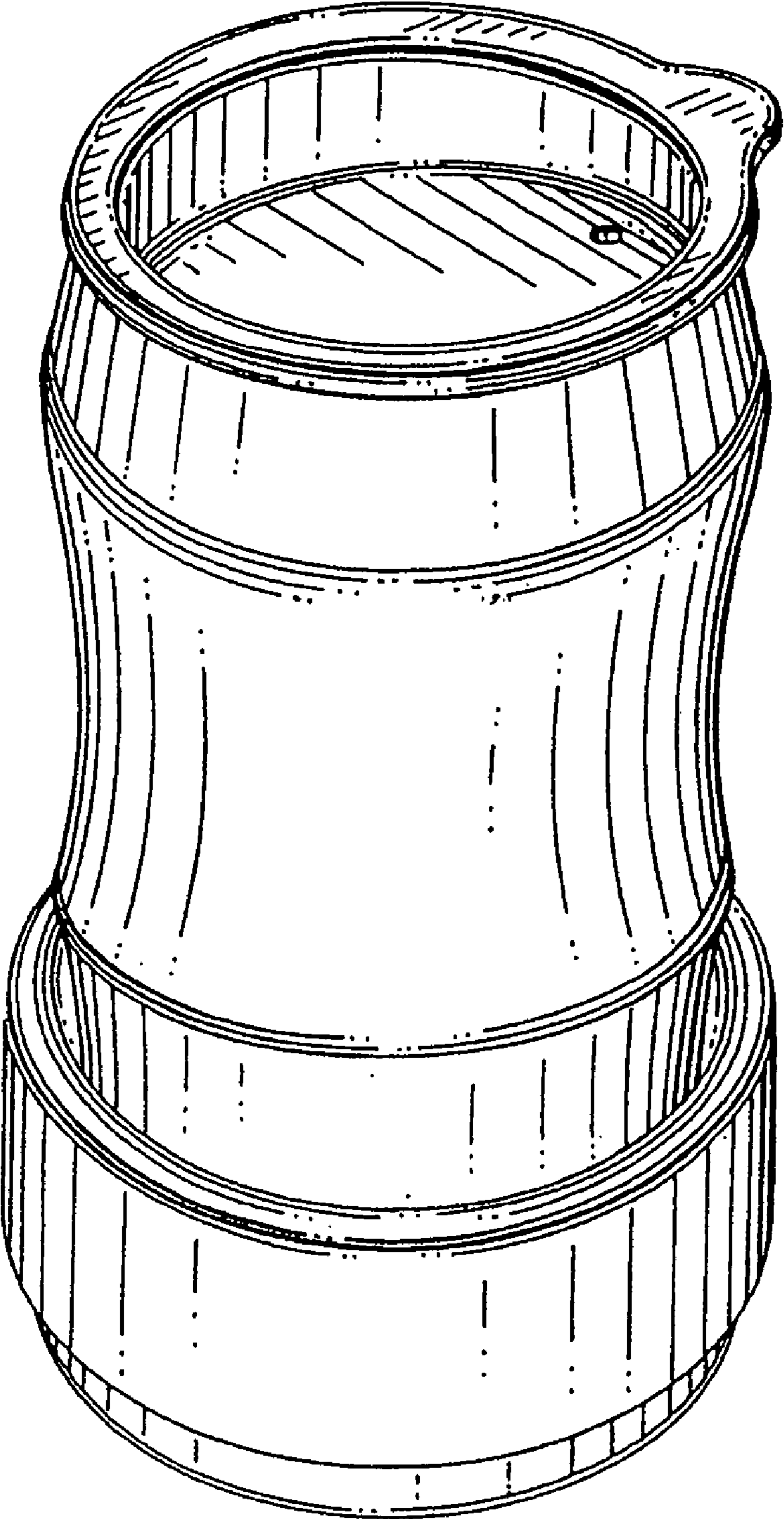

FIG. 1

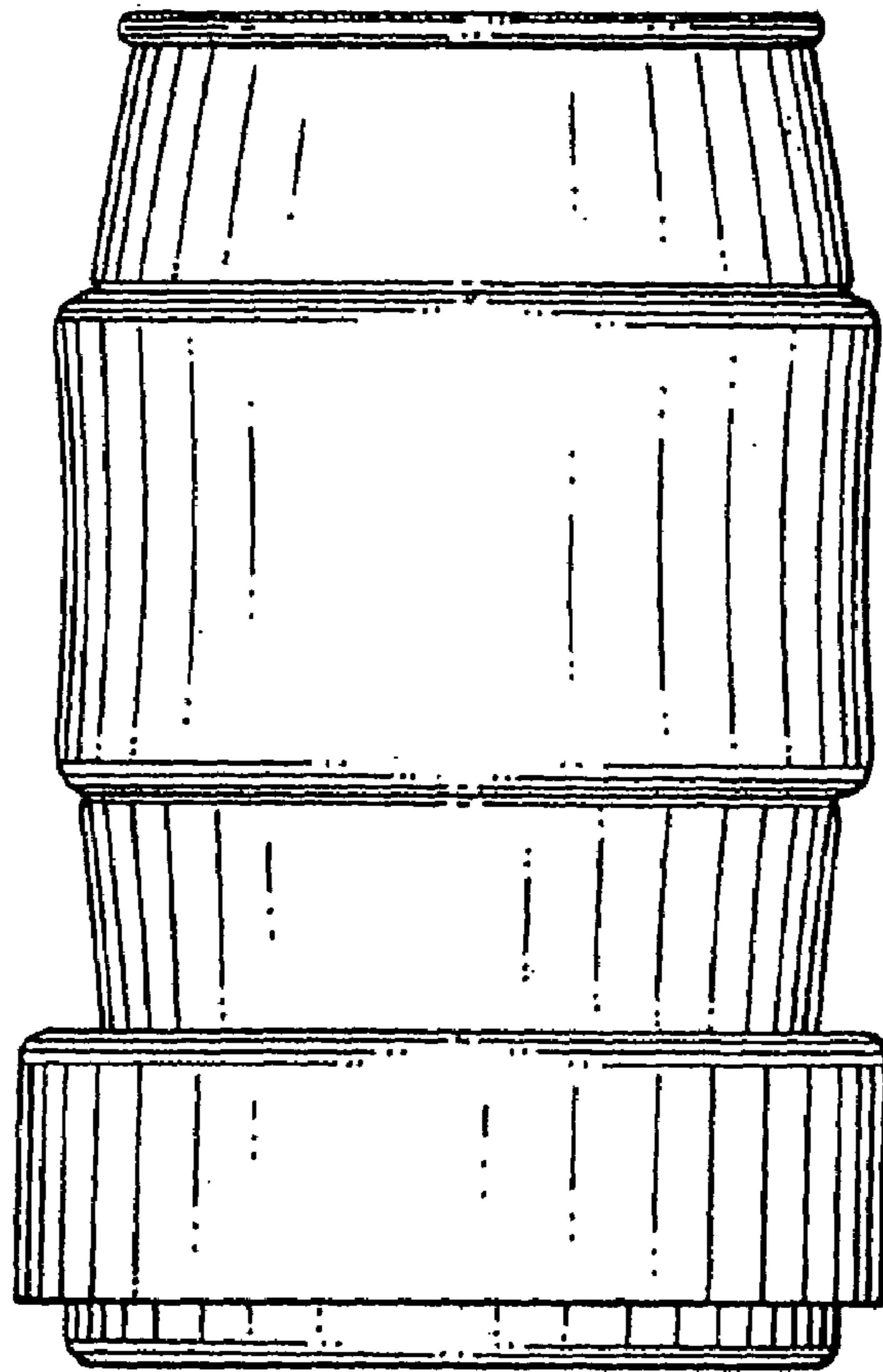

FIG. 2

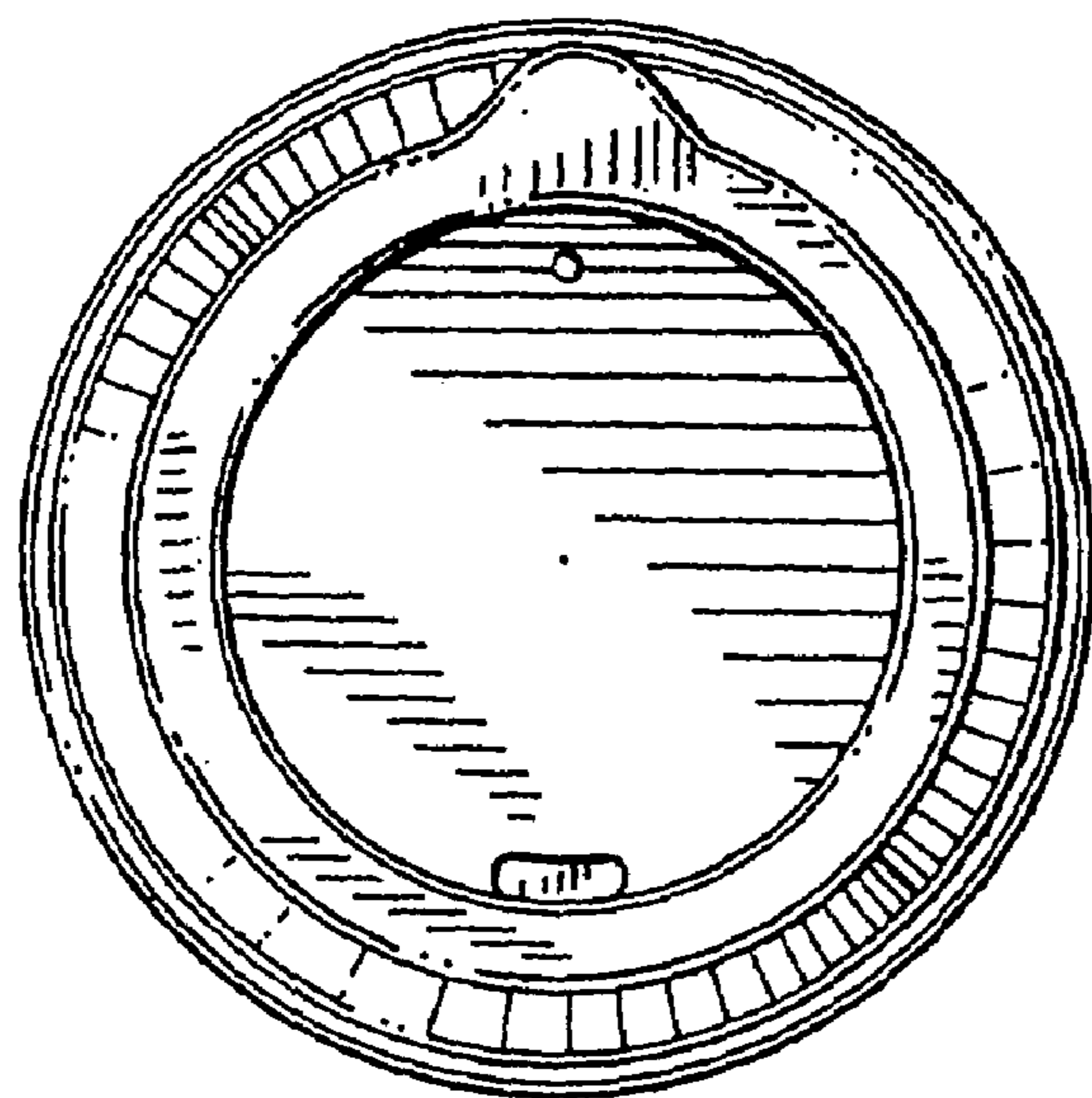
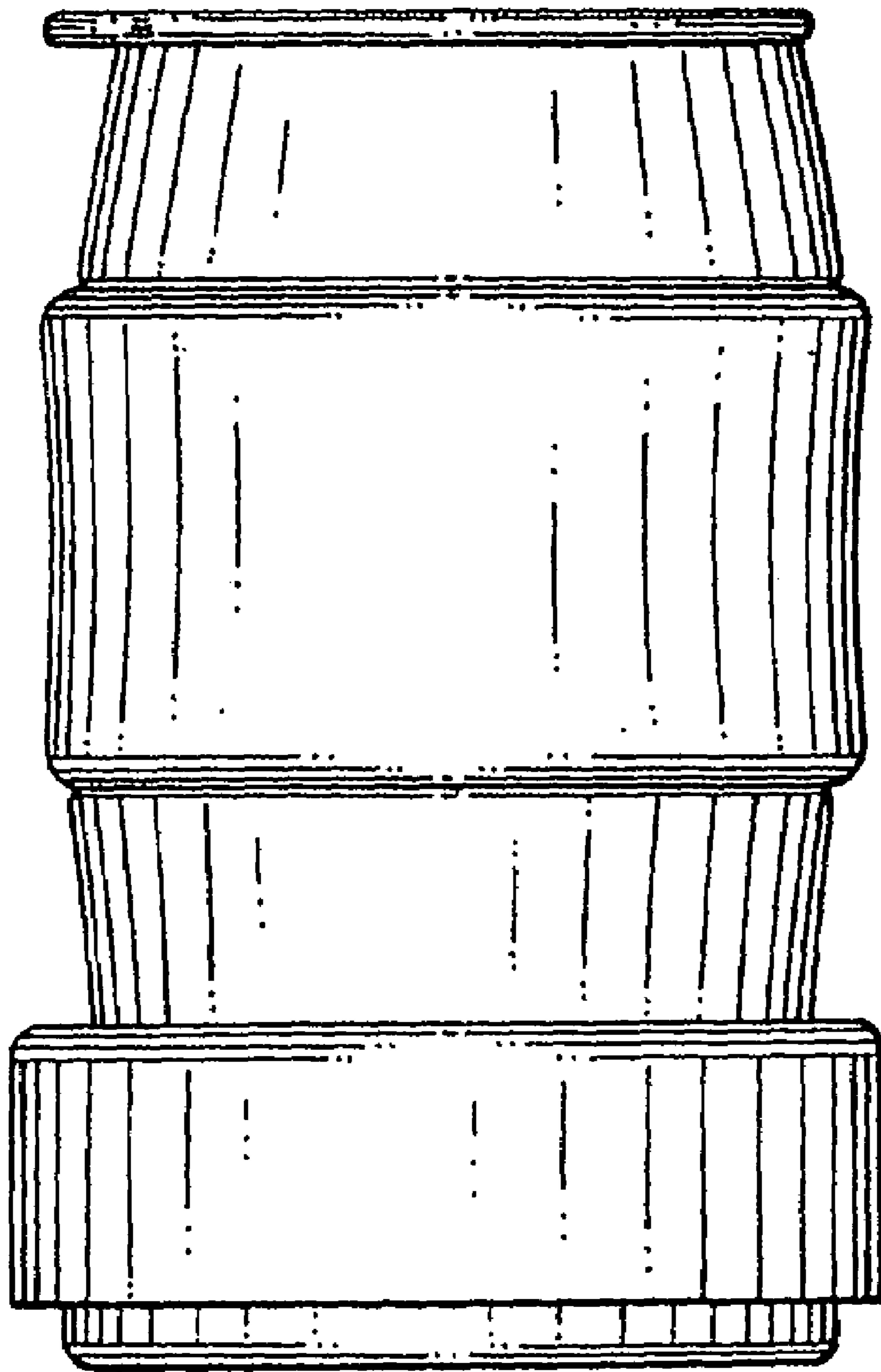

FIG. 3

FIG. 4



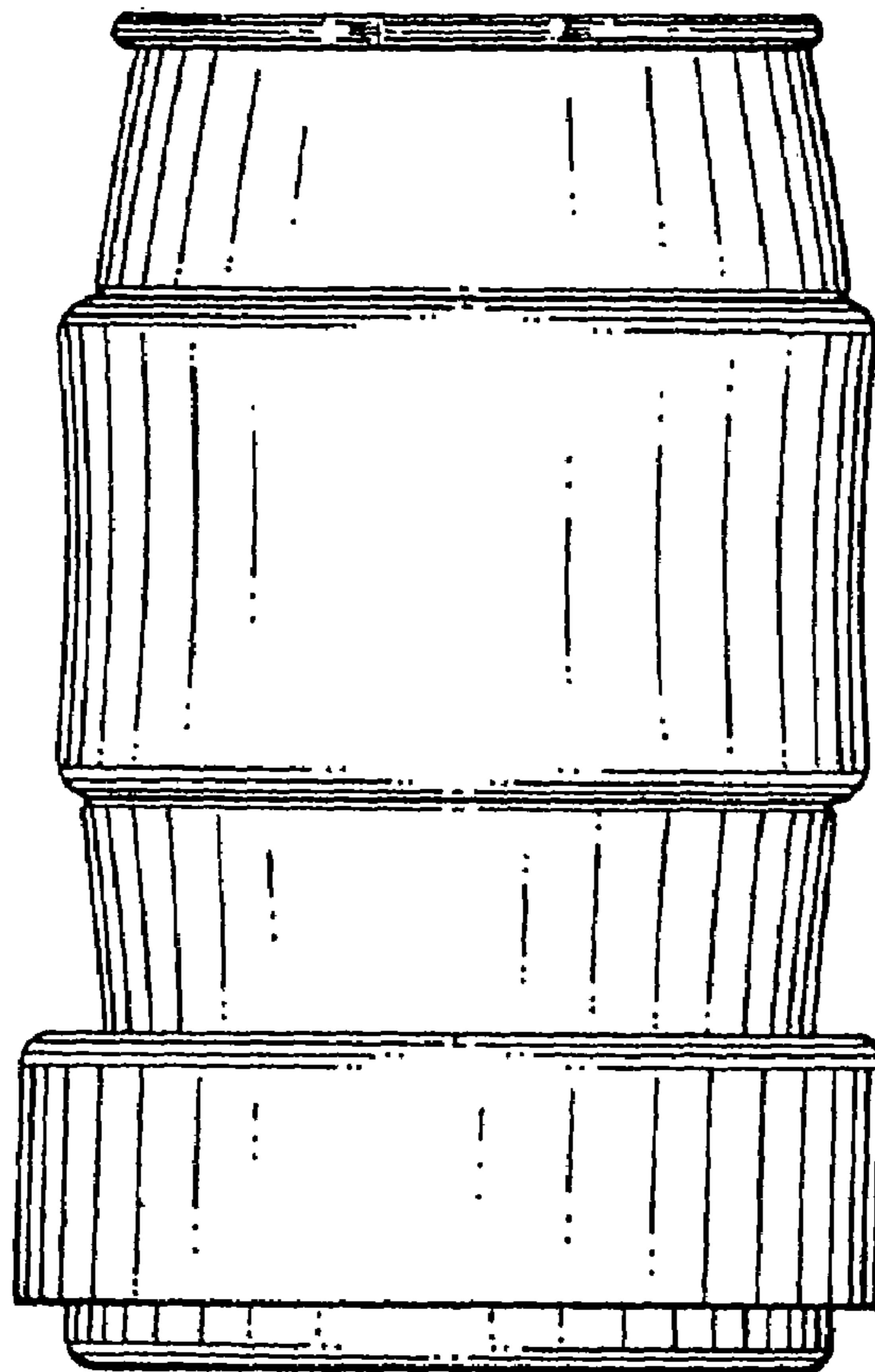

FIG. 5

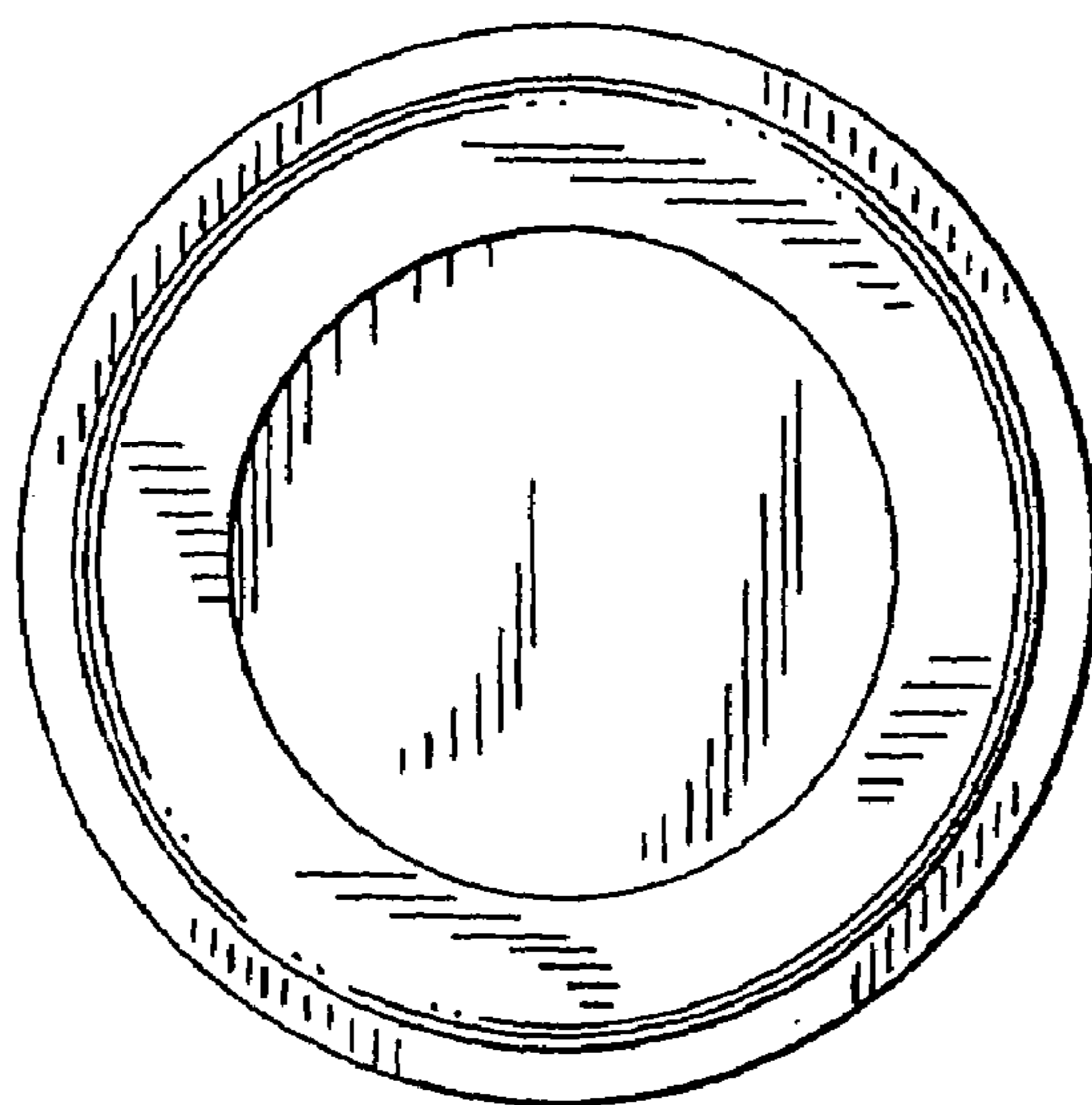
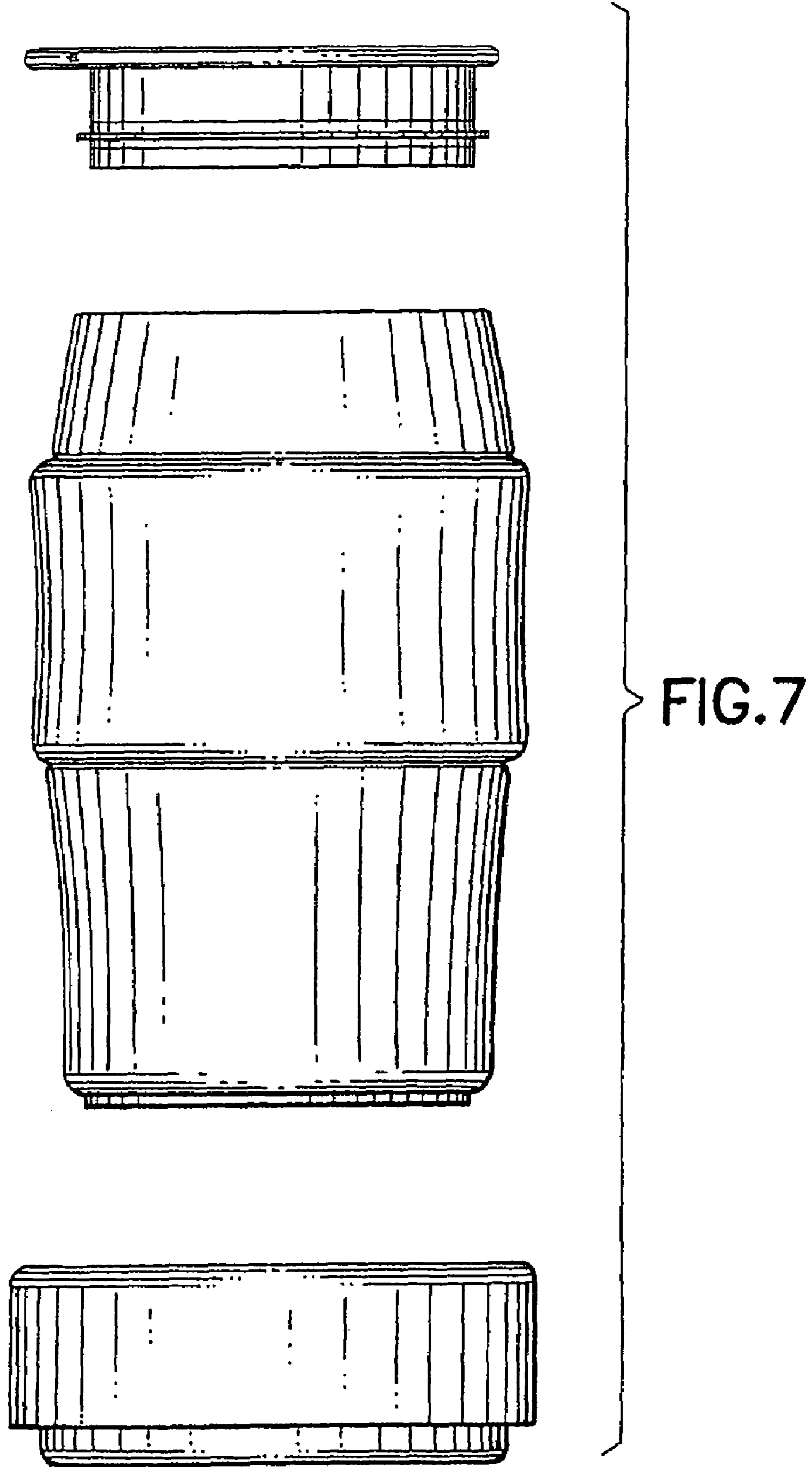

FIG. 6



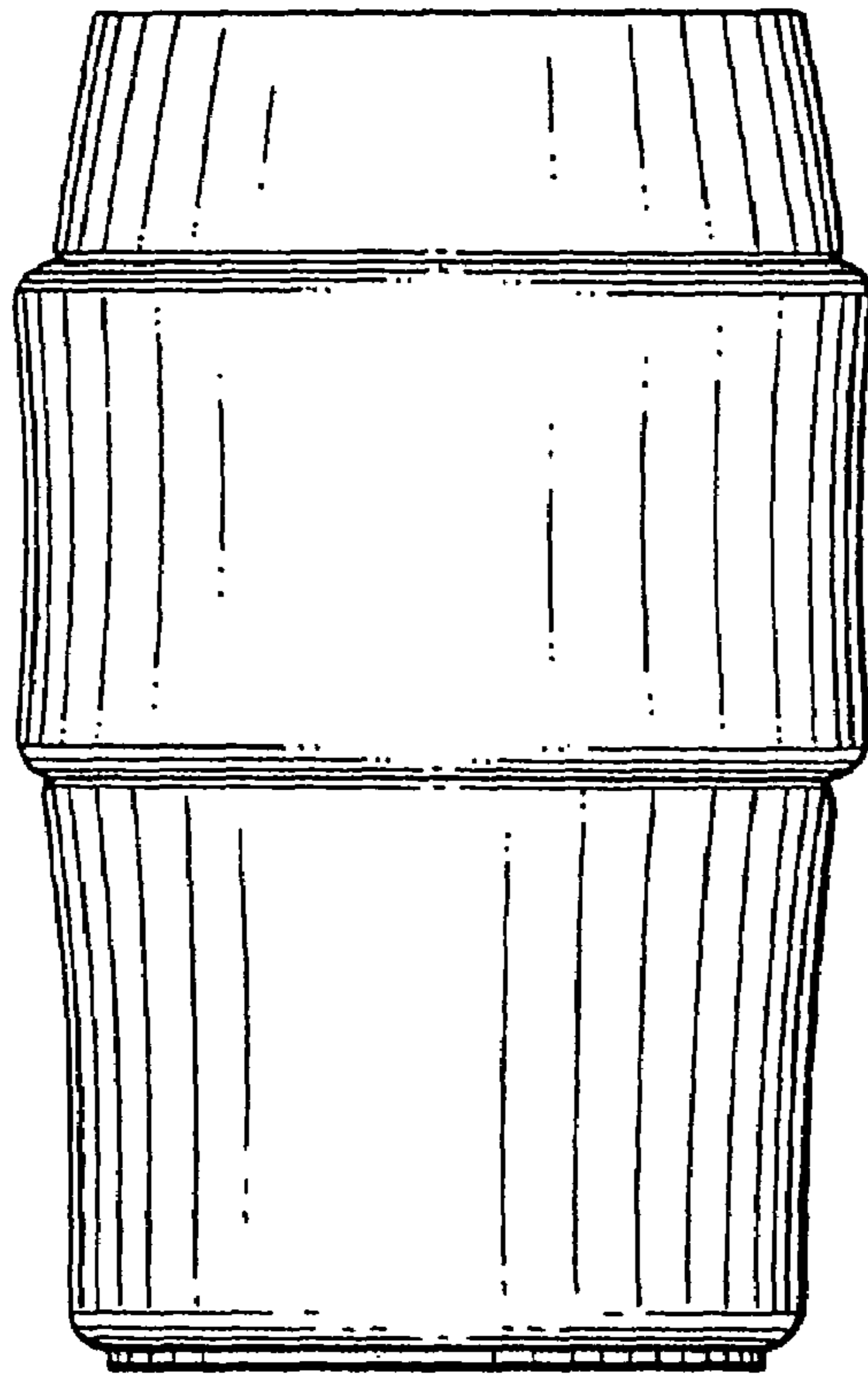

FIG. 8

FIG. 9

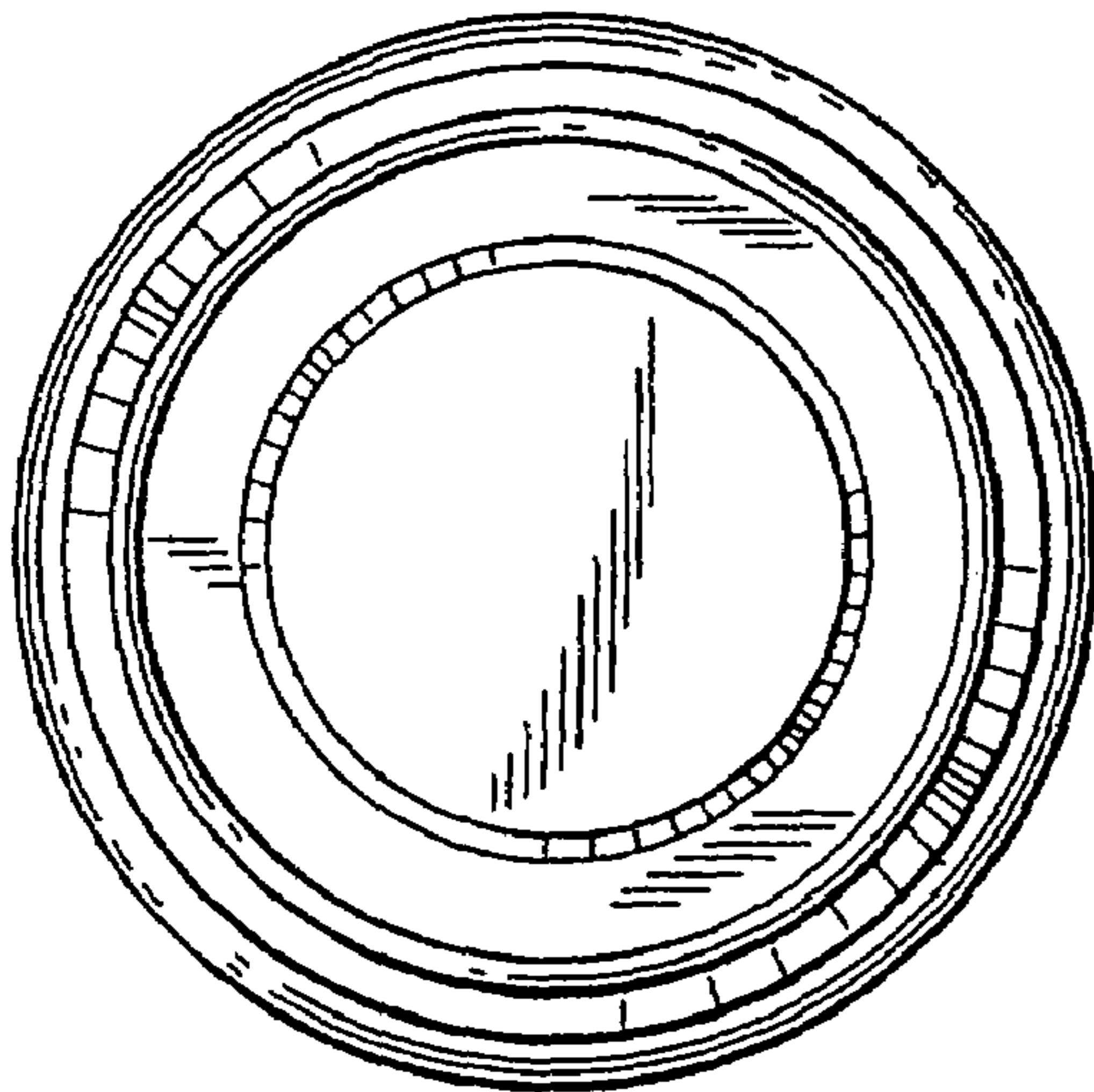
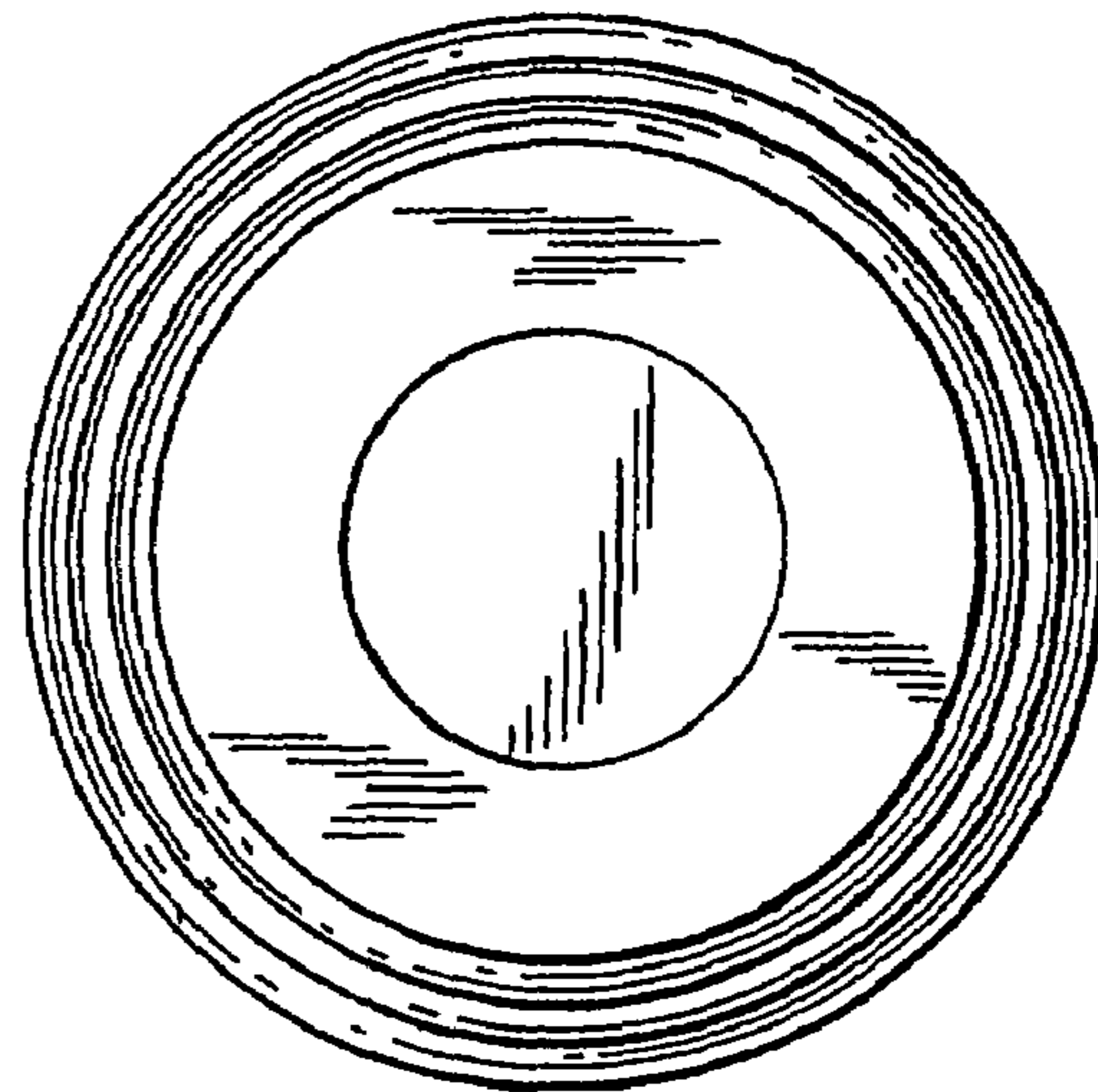

FIG. 10



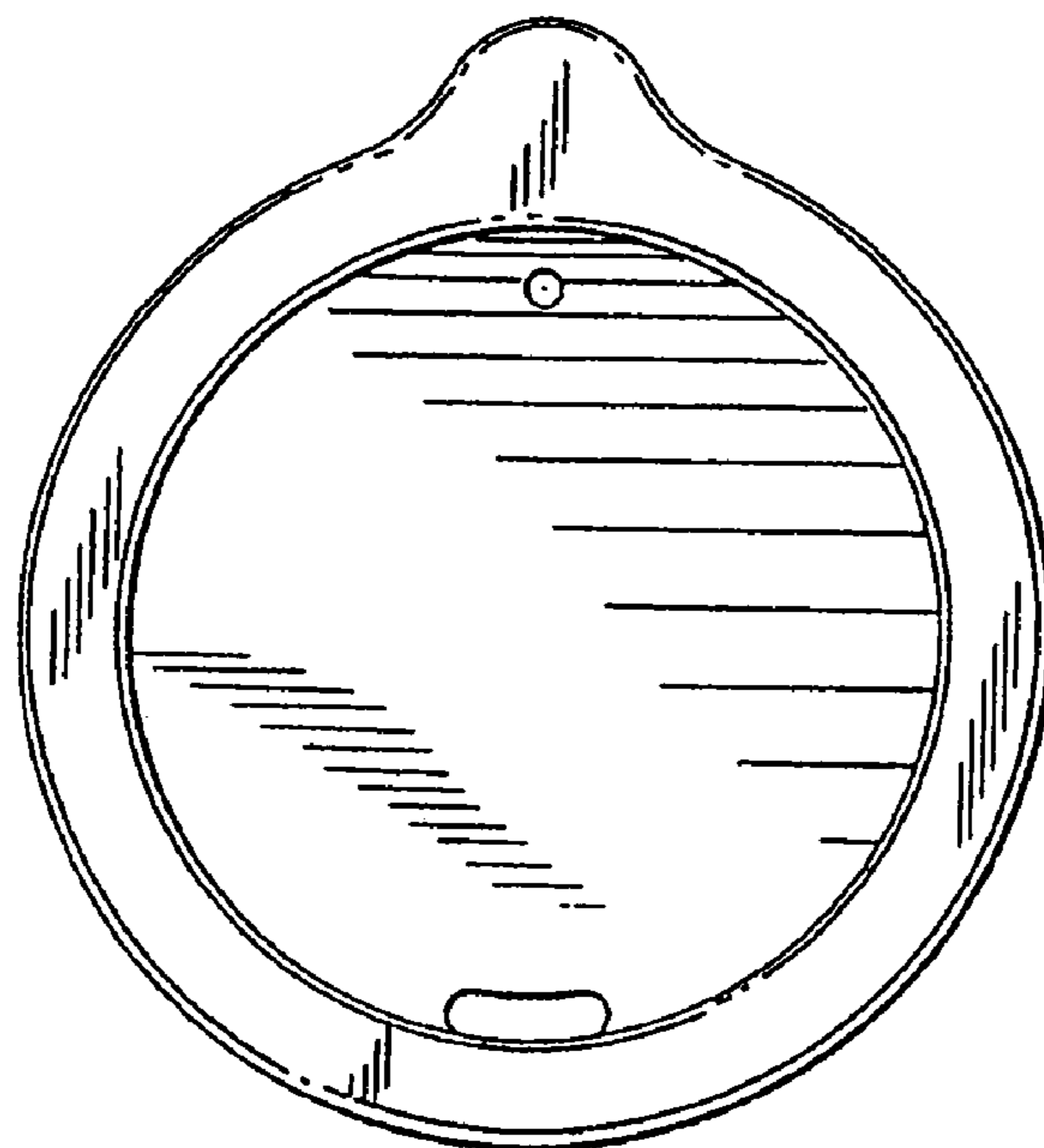

FIG. 11

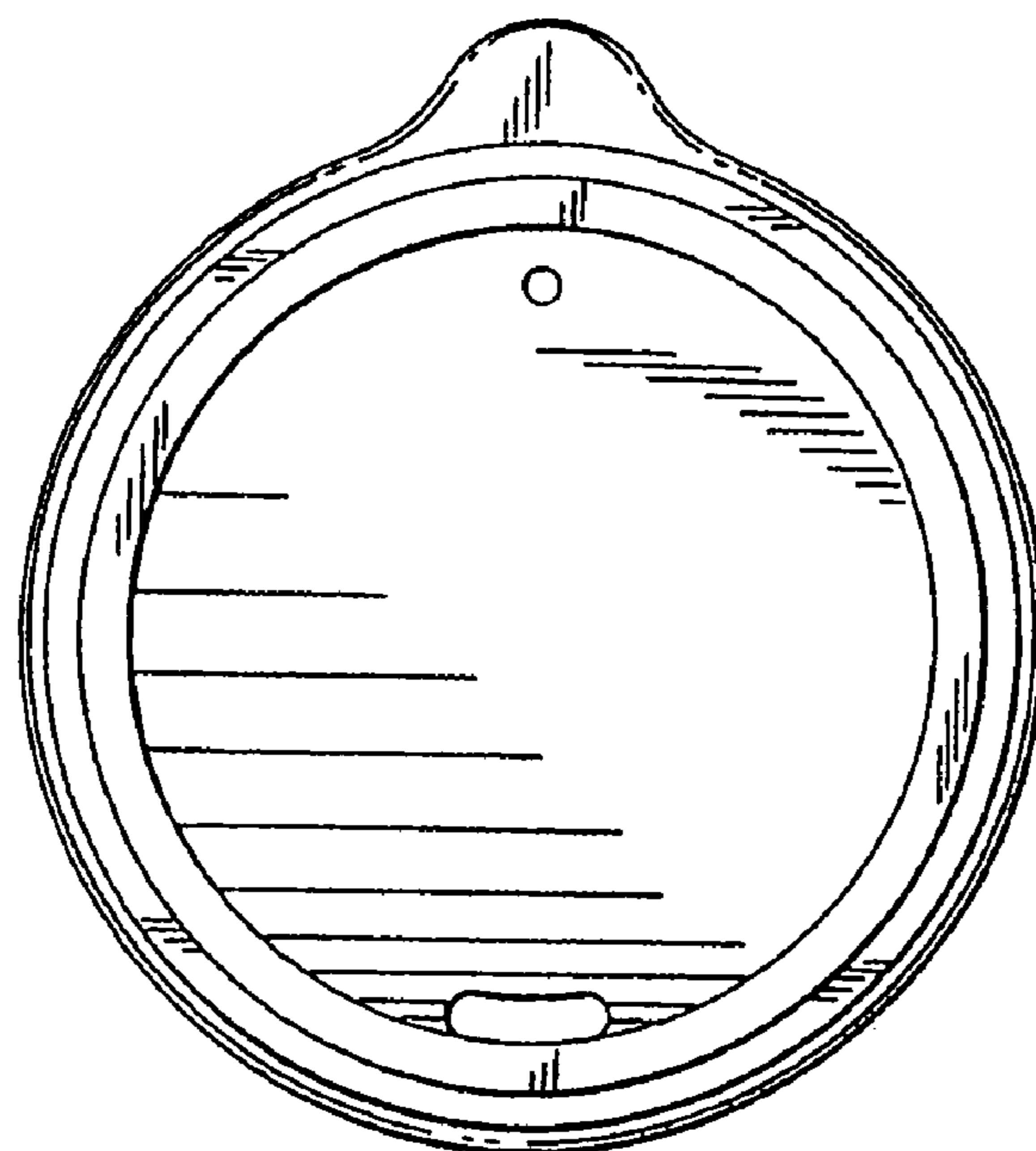

FIG. 12

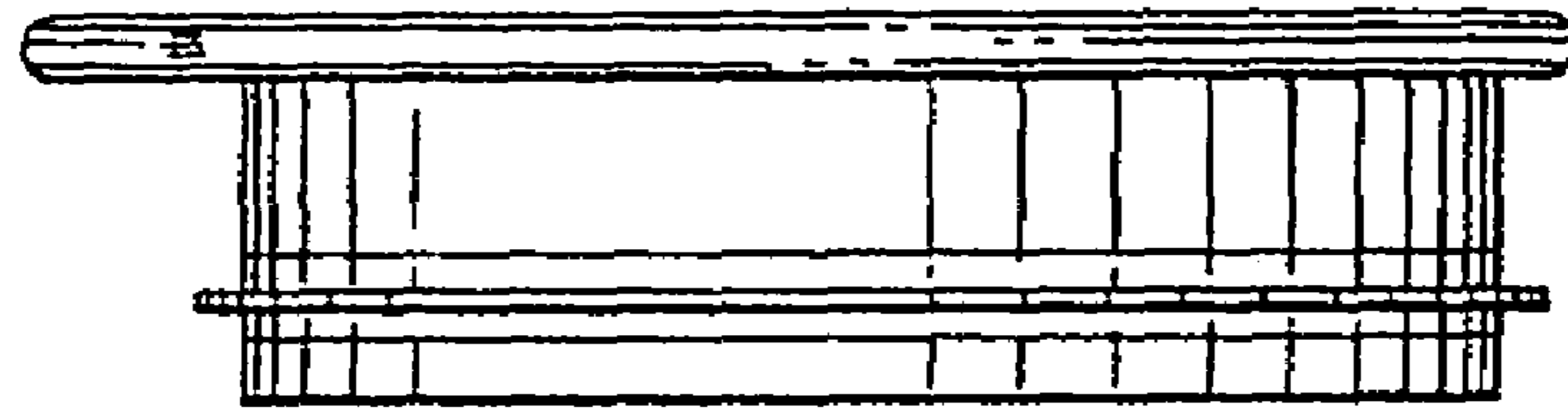

FIG. 13

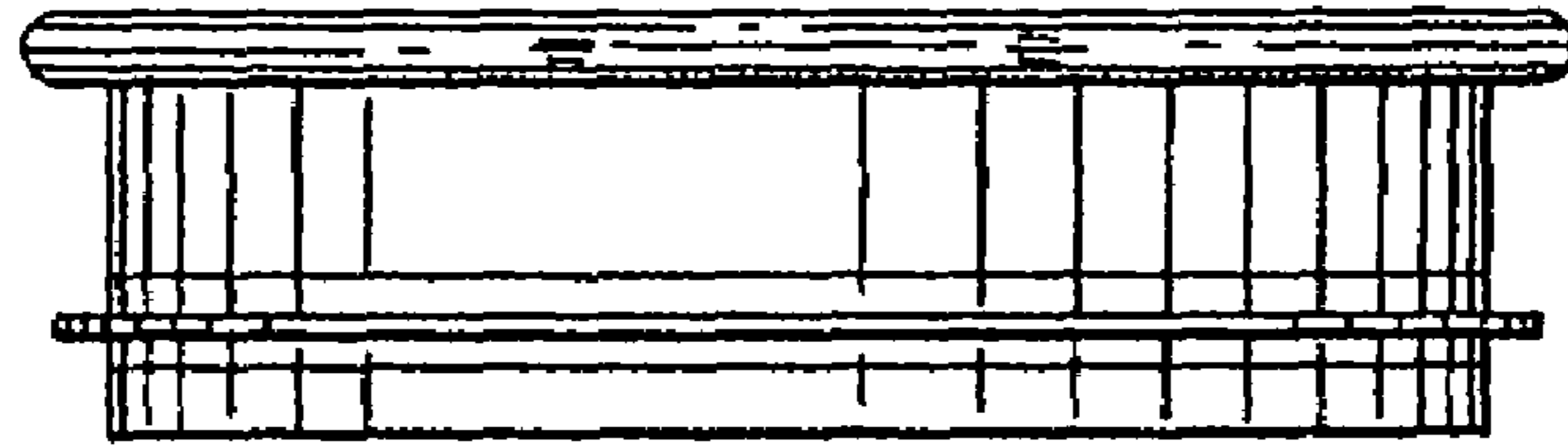

FIG. 14

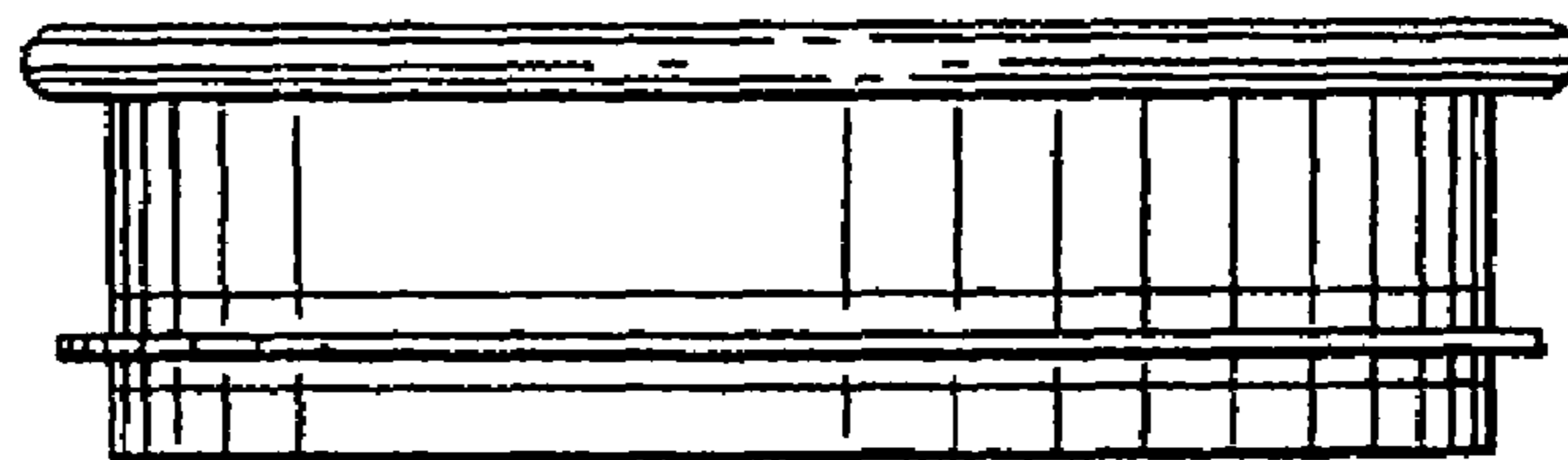

FIG. 15

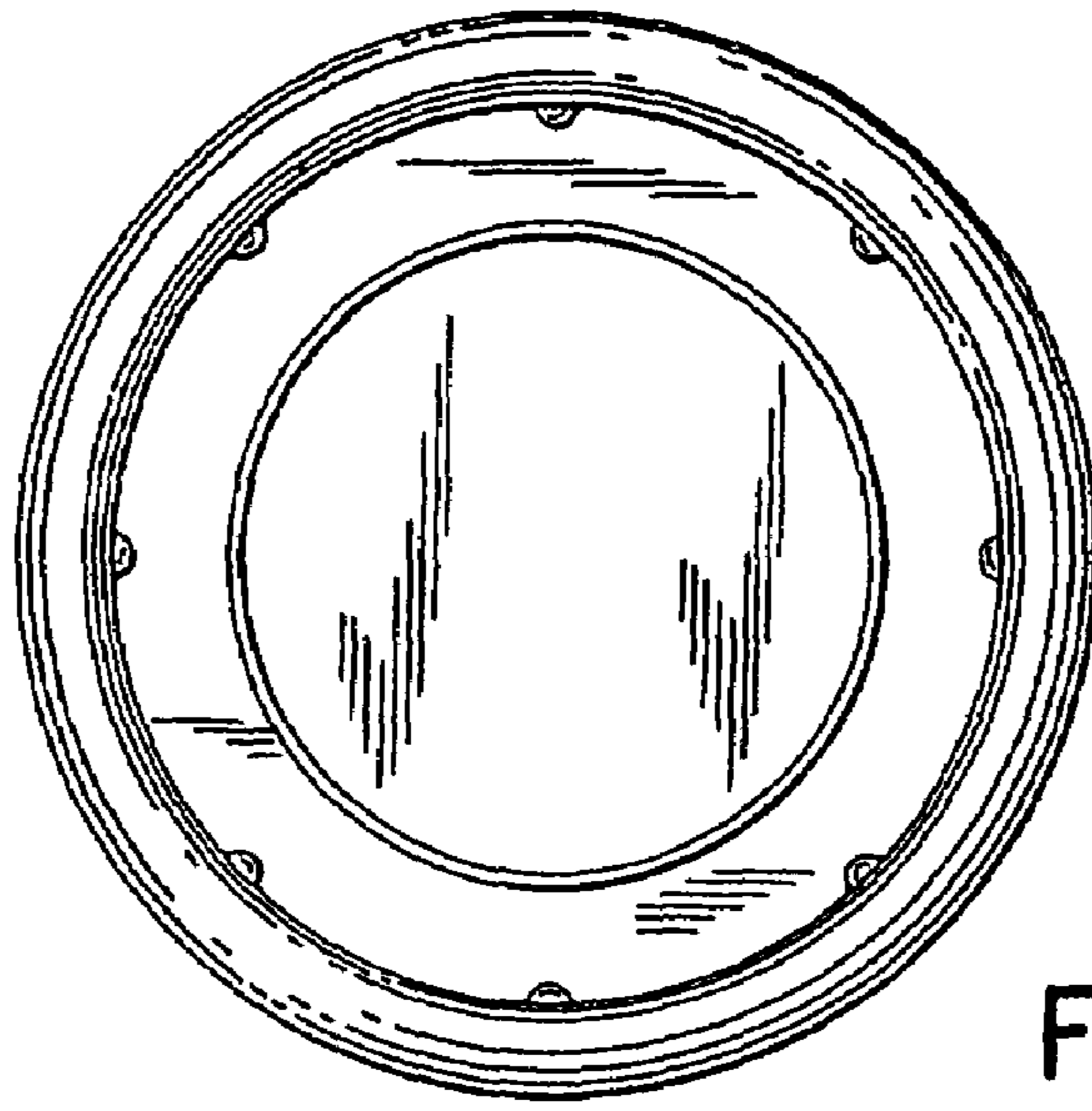

FIG. 16

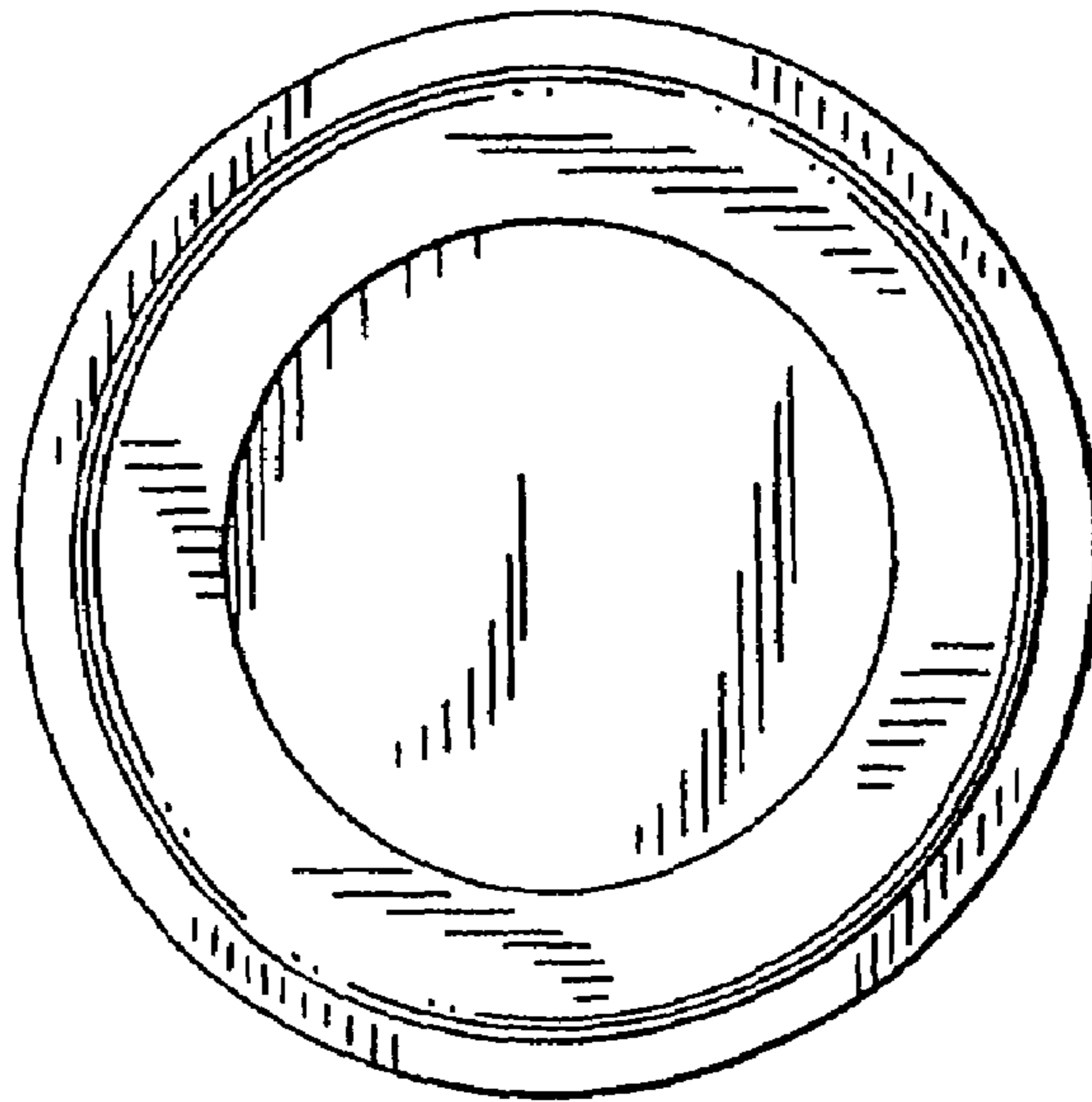

FIG. 17

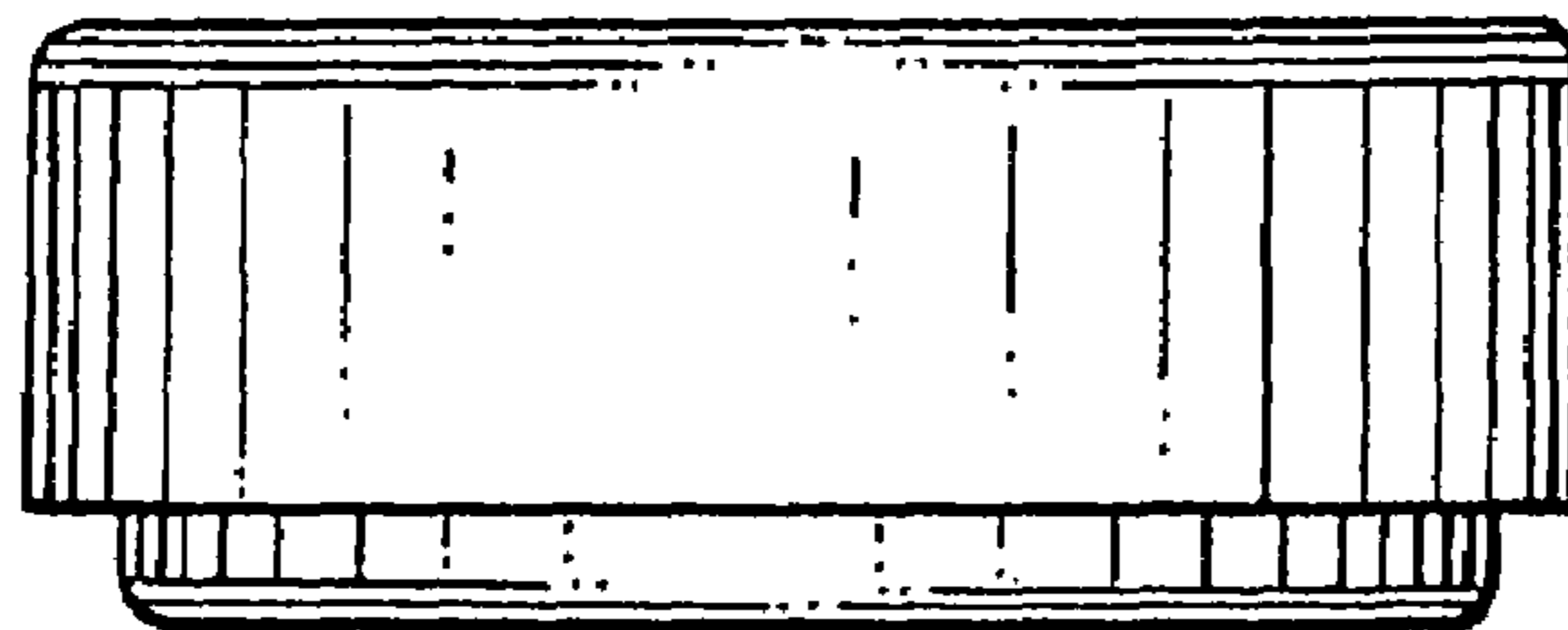

FIG. 18