



US00D556409S

(12) **United States Design Patent**  
**Yoo**

(10) **Patent No.:** **US D556,409 S**

(45) **Date of Patent:** **\*\* Nov. 27, 2007**

(54) **WATER BUCKET FOR PORTABLE IRRIGATOR**

(76) Inventor: **Byung Eun Yoo**, 616-5, Daemyeong-9dong, Nam-gu, Daegu 705-805 (KR)

(\*\*) Term: **14 Years**

(21) Appl. No.: **29/259,503**

(22) Filed: **May 10, 2006**

(30) **Foreign Application Priority Data**

Jan. 2, 2006 (KR) ..... 30-2006-0000036

(51) **LOC (8) Cl.** ..... **07-07**

(52) **U.S. Cl.** ..... **D32/53; D32/1**

(58) **Field of Classification Search** ..... D32/1, D32/35, 53-54; D24/216-234, 111, 176, D24/108; 422/26-28, 31, 292, 300-301, 422/305; 220/760; 601/162, 165; 239/724; 405/90; 134/169 A, 58 R, 111, 200, 186, 134/180, 107, 135, 188, 198

See application file for complete search history.

(56) **References Cited**

**U.S. PATENT DOCUMENTS**

D322,337 S \* 12/1991 Padgett ..... D32/1  
D384,446 S \* 9/1997 Linton et al. .... D32/1  
5,788,466 A \* 8/1998 Thompson ..... 417/360  
D406,416 S \* 3/1999 Chan ..... D32/1  
D406,417 S \* 3/1999 Linton et al. .... D32/1

6,390,104 B1 \* 5/2002 Gagnon ..... 134/107  
D463,076 S \* 9/2002 Nottingham et al. .... D32/1  
D469,175 S \* 1/2003 Hall et al. .... D24/108  
D478,659 S \* 8/2003 Hall et al. .... D24/108

\* cited by examiner

*Primary Examiner*—Pamela J. Burgess

(74) *Attorney, Agent, or Firm*—Cantor Colburn LLP

(57) **CLAIM**

I claim, the ornamental design for a water bucket for portable irrigator, as shown and described.

**DESCRIPTION**

FIG. 1 is a top and front perspective view of a water bucket for portable irrigator, showing our new design;

FIG. 2 is a front elevational view thereof;

FIG. 3 is a rear elevational view thereof;

FIG. 4 is a left side elevational view thereof;

FIG. 5 is a right side elevational view thereof;

FIG. 6 is a top plan view thereof;

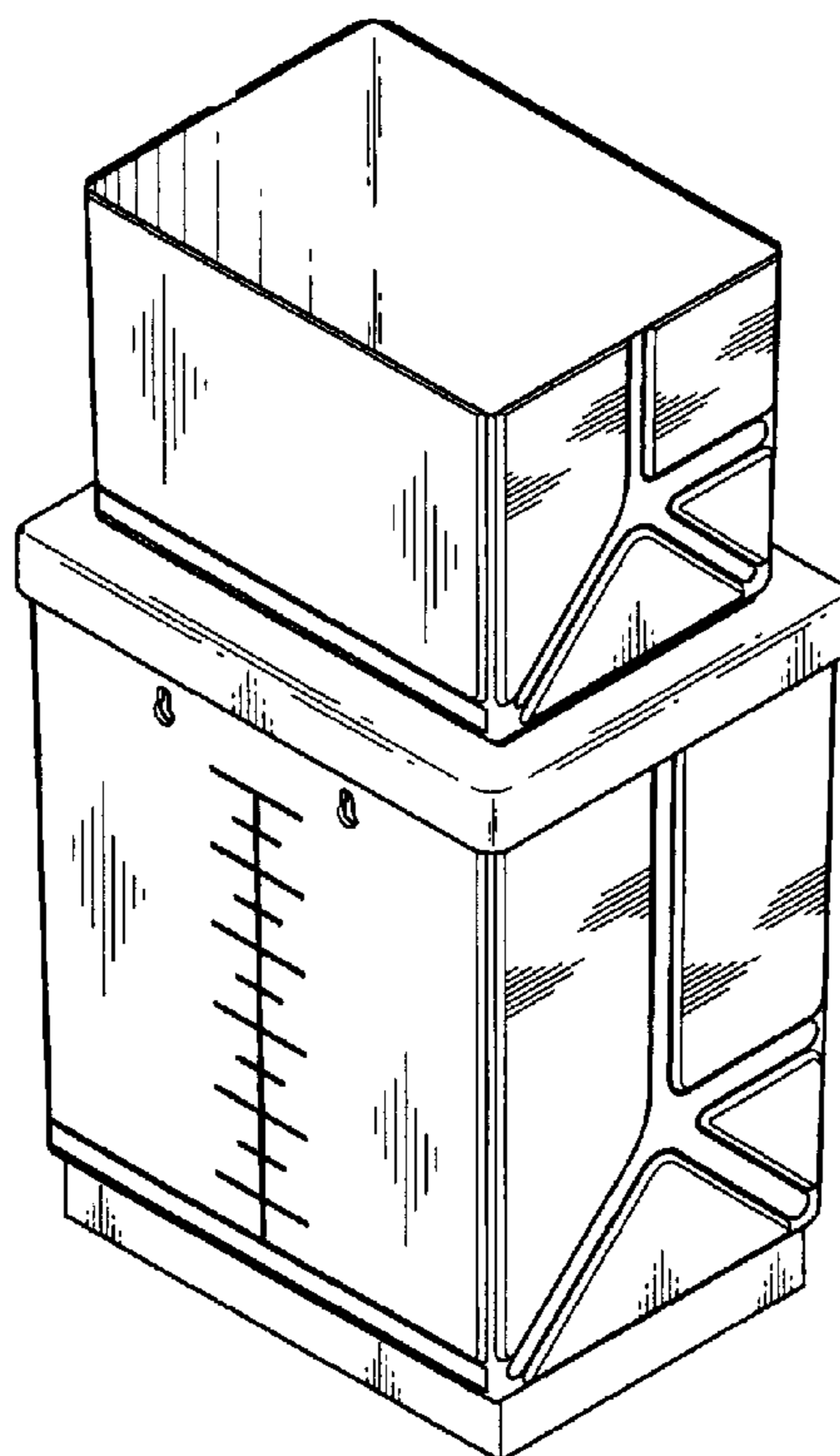
FIG. 7 is a bottom plan view thereof;

FIG. 8 is a cross-sectional view thereof taken along line A—A in FIG. 6;

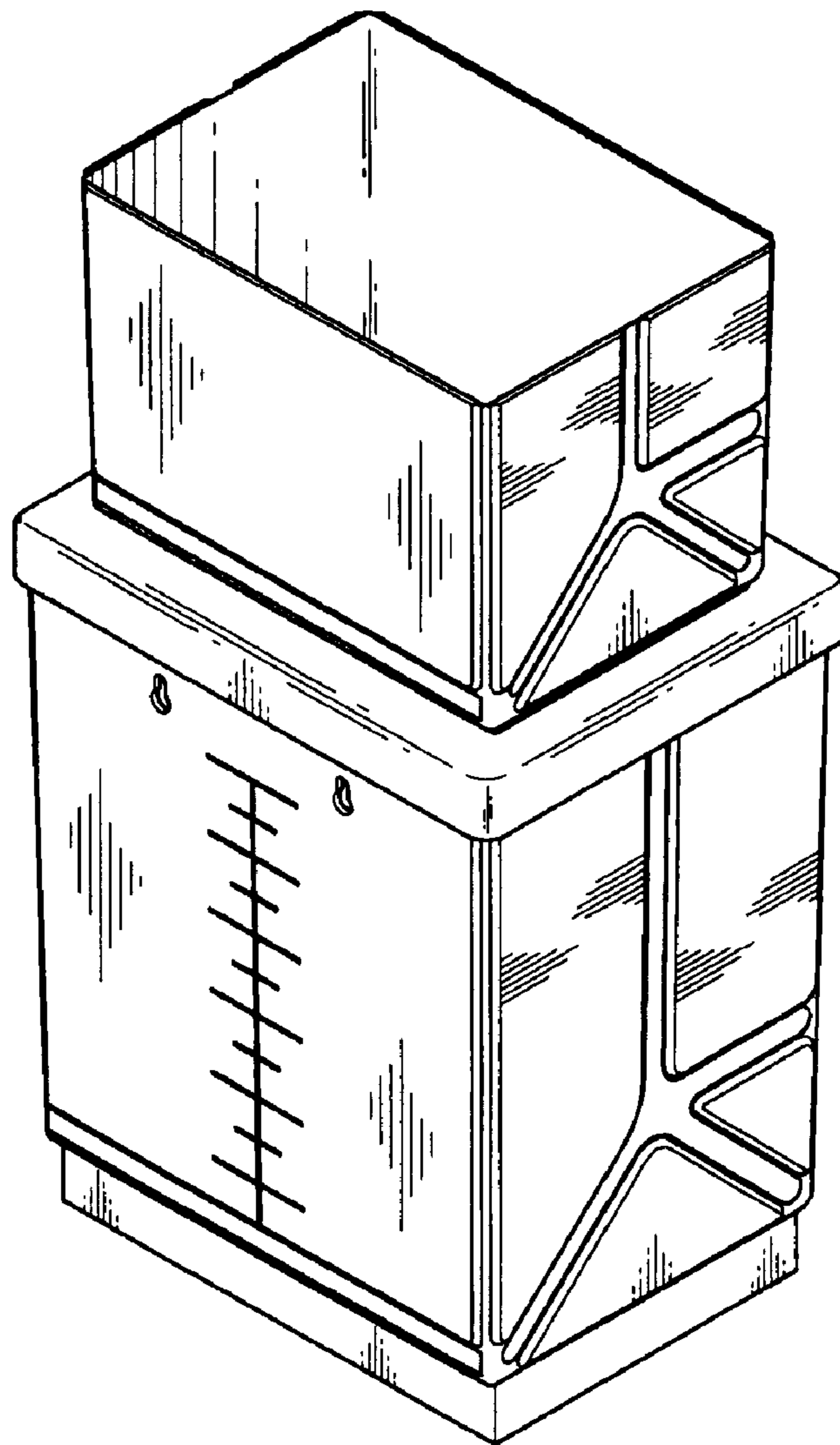
FIG. 9 is a cross-sectional view thereof taken along line B—B in FIG. 6; and,

FIG. 10 is a top rear perspective view thereof.

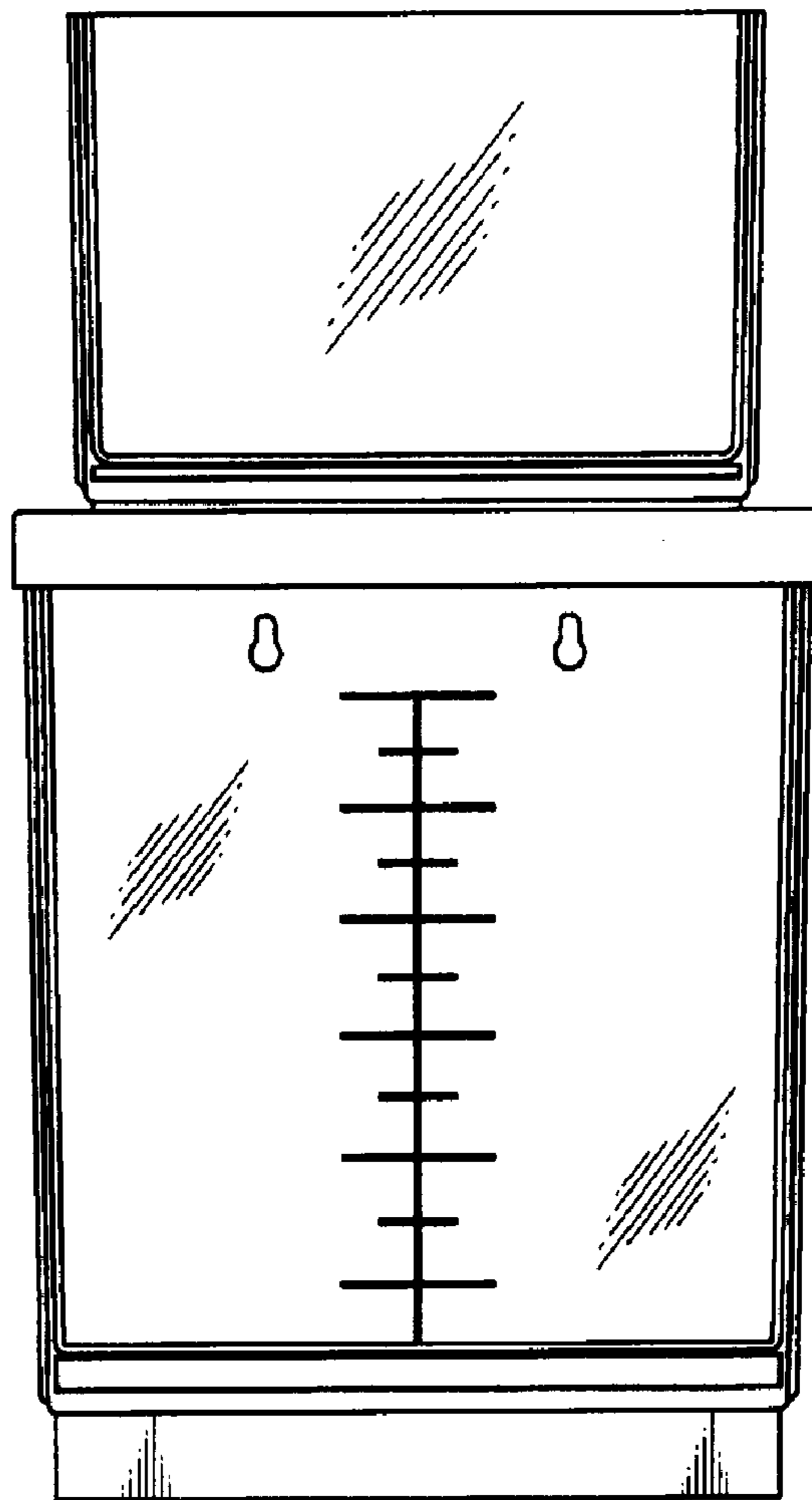
**1 Claim, 9 Drawing Sheets**



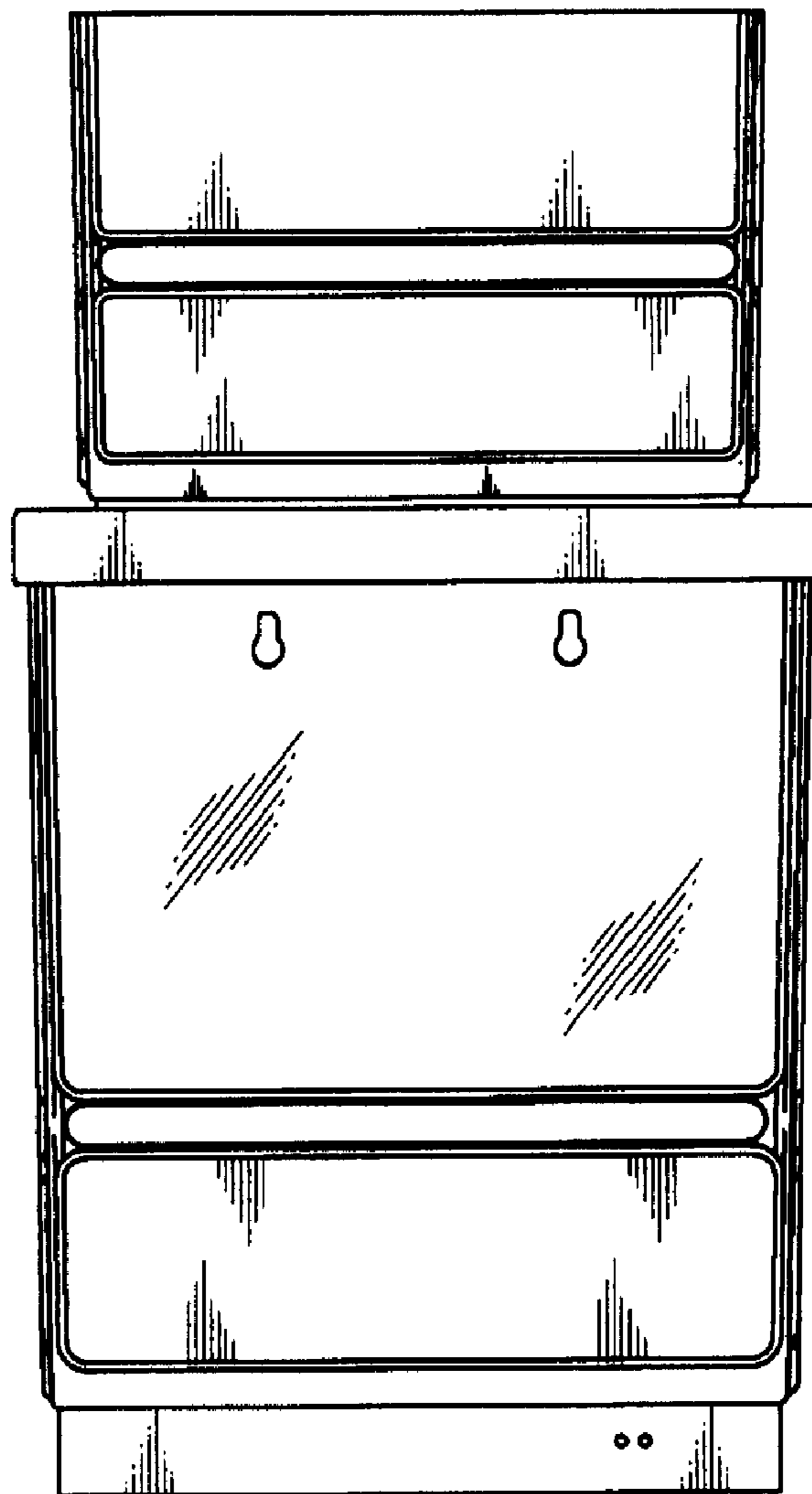
**FIG. 1**



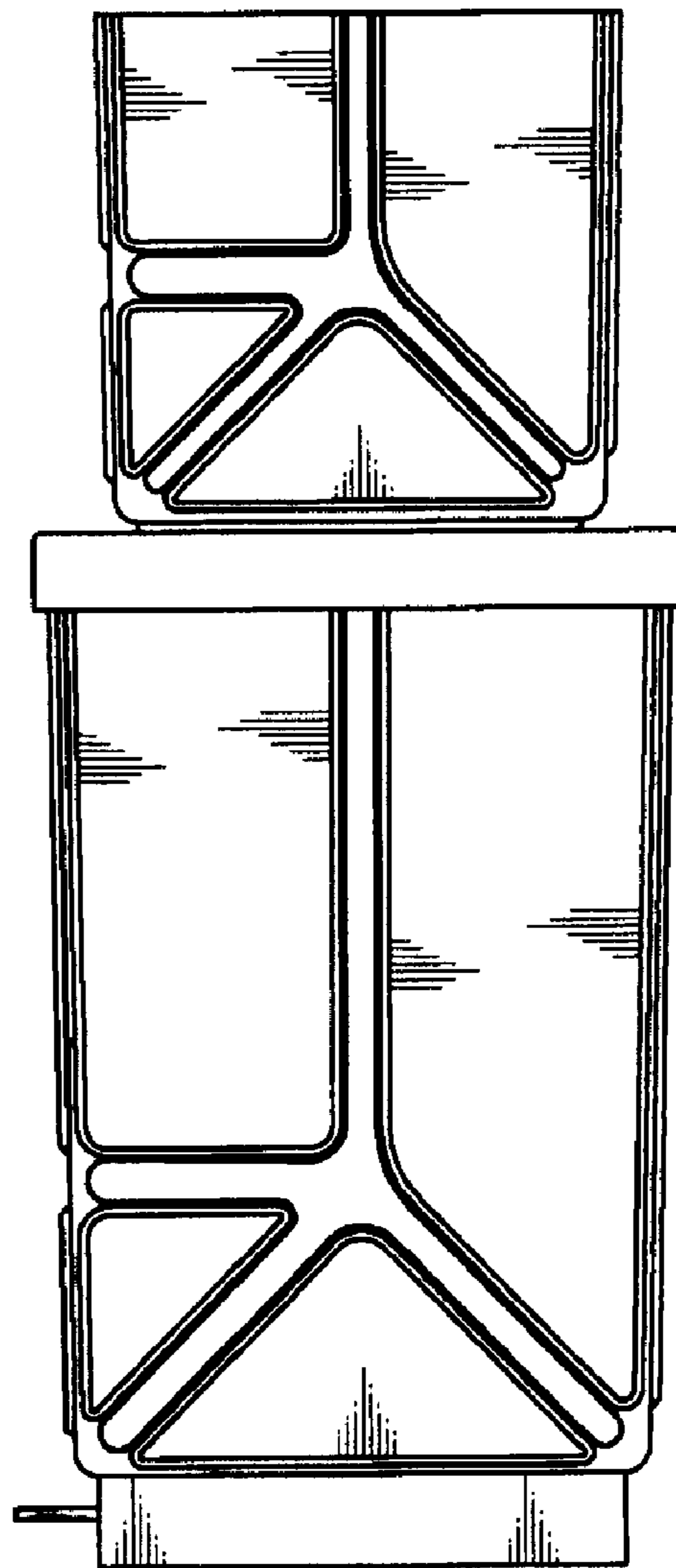
**FIG. 2**



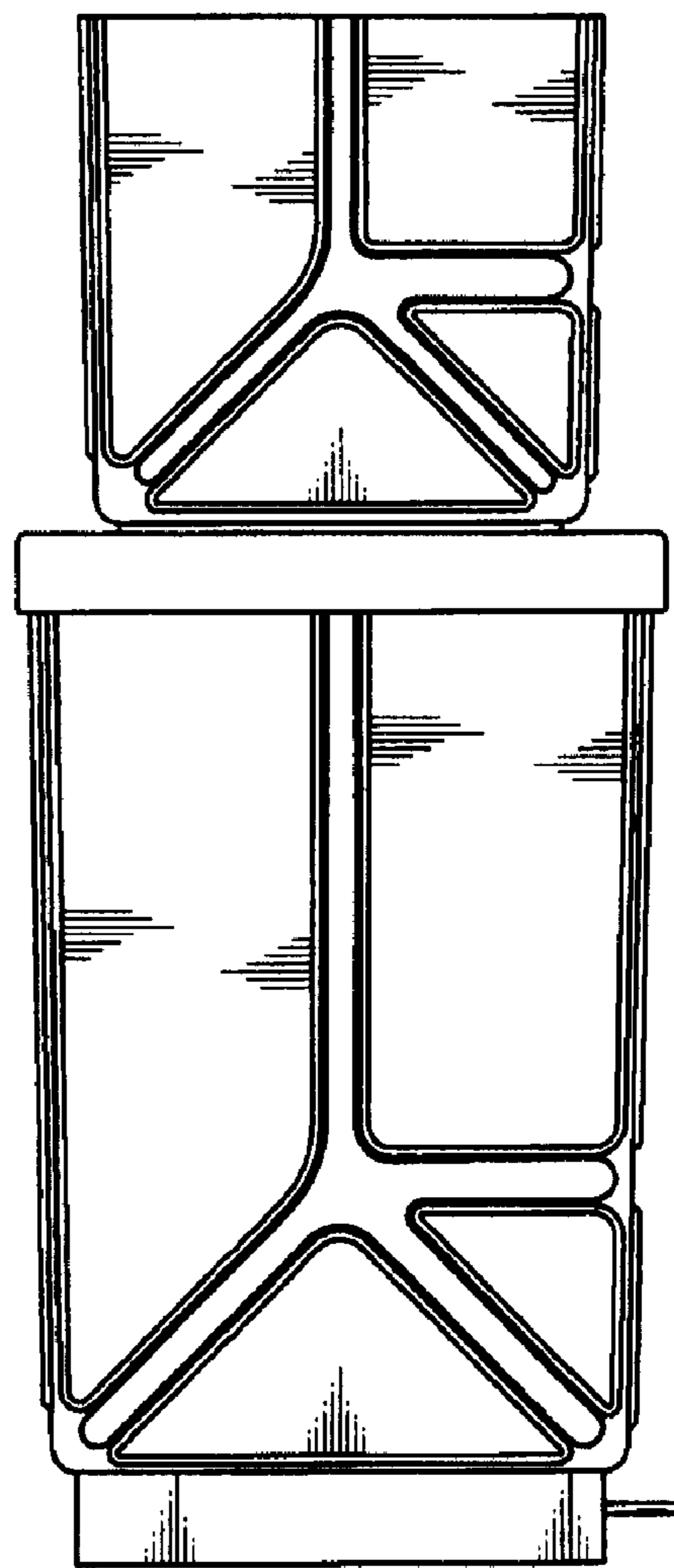
**FIG. 3**



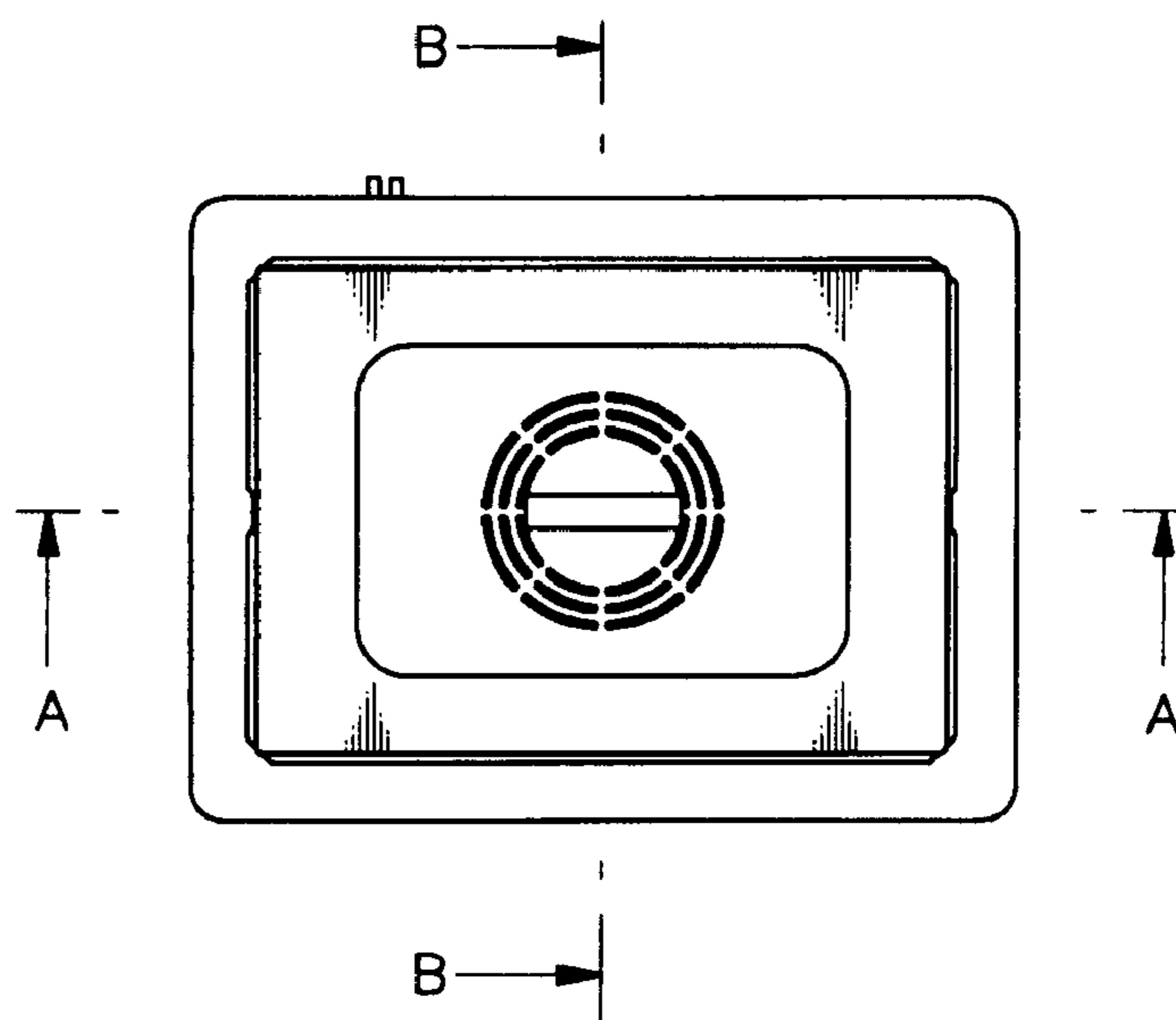
**FIG. 4**



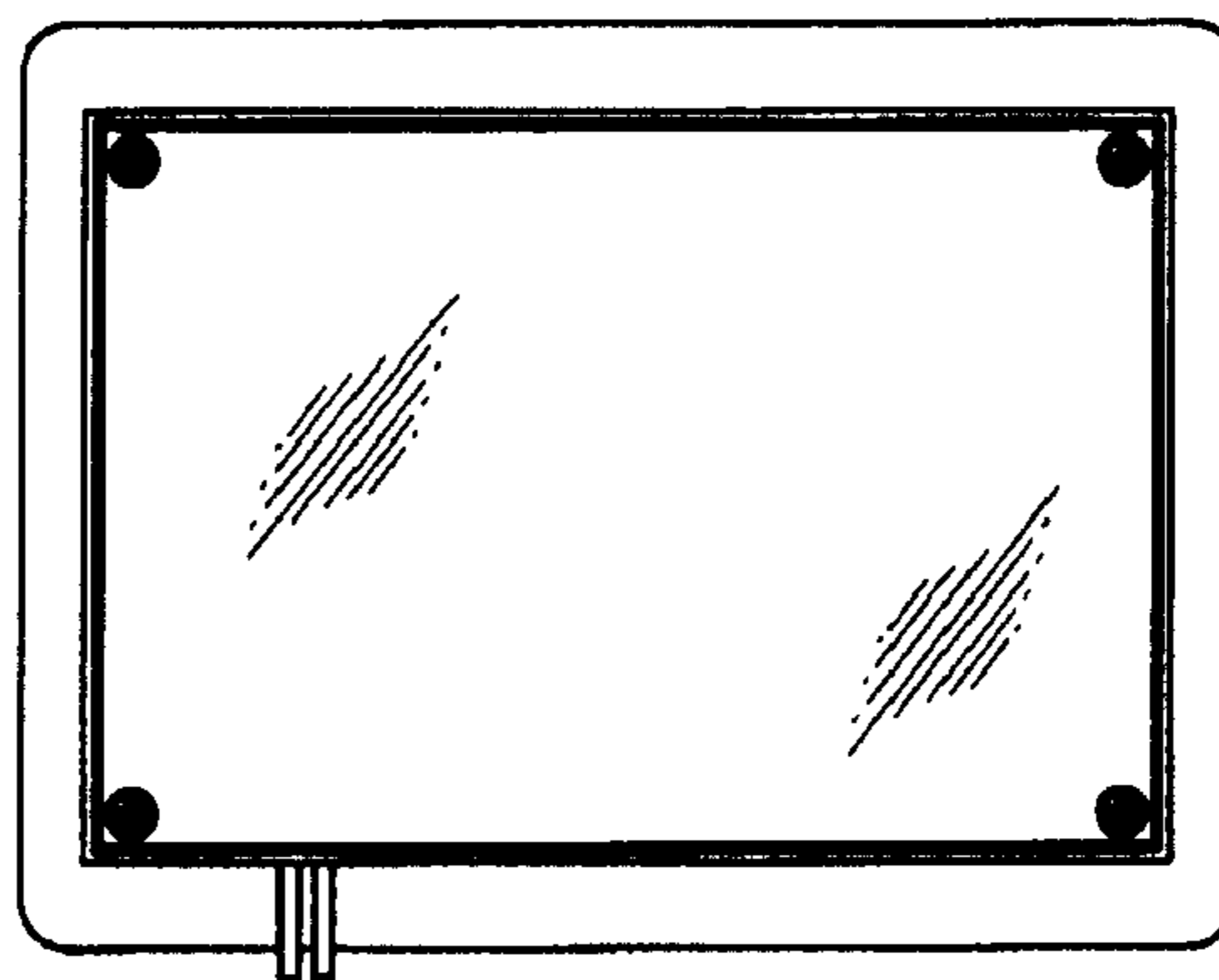
**FIG. 5**



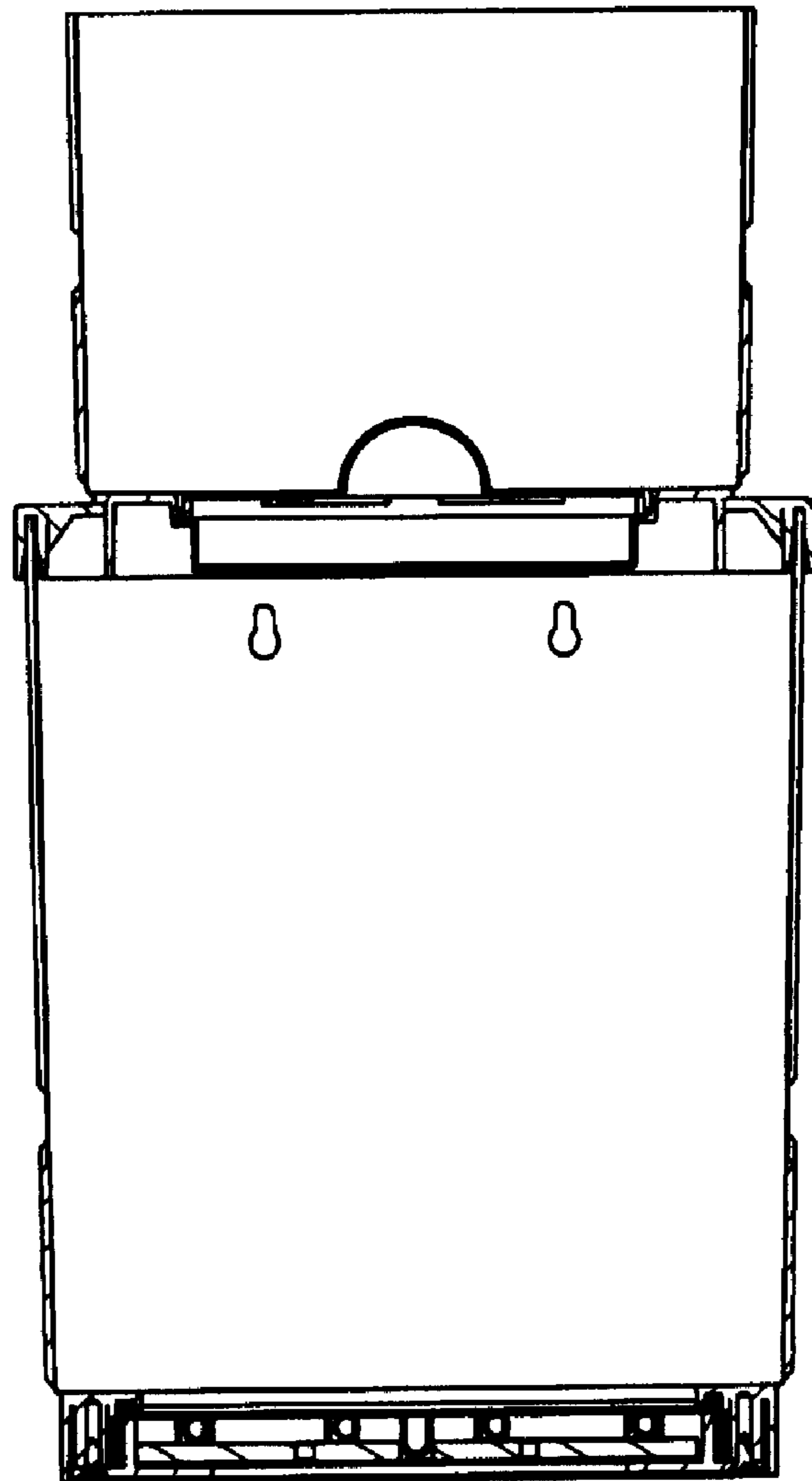
**FIG. 6**



**FIG. 7**

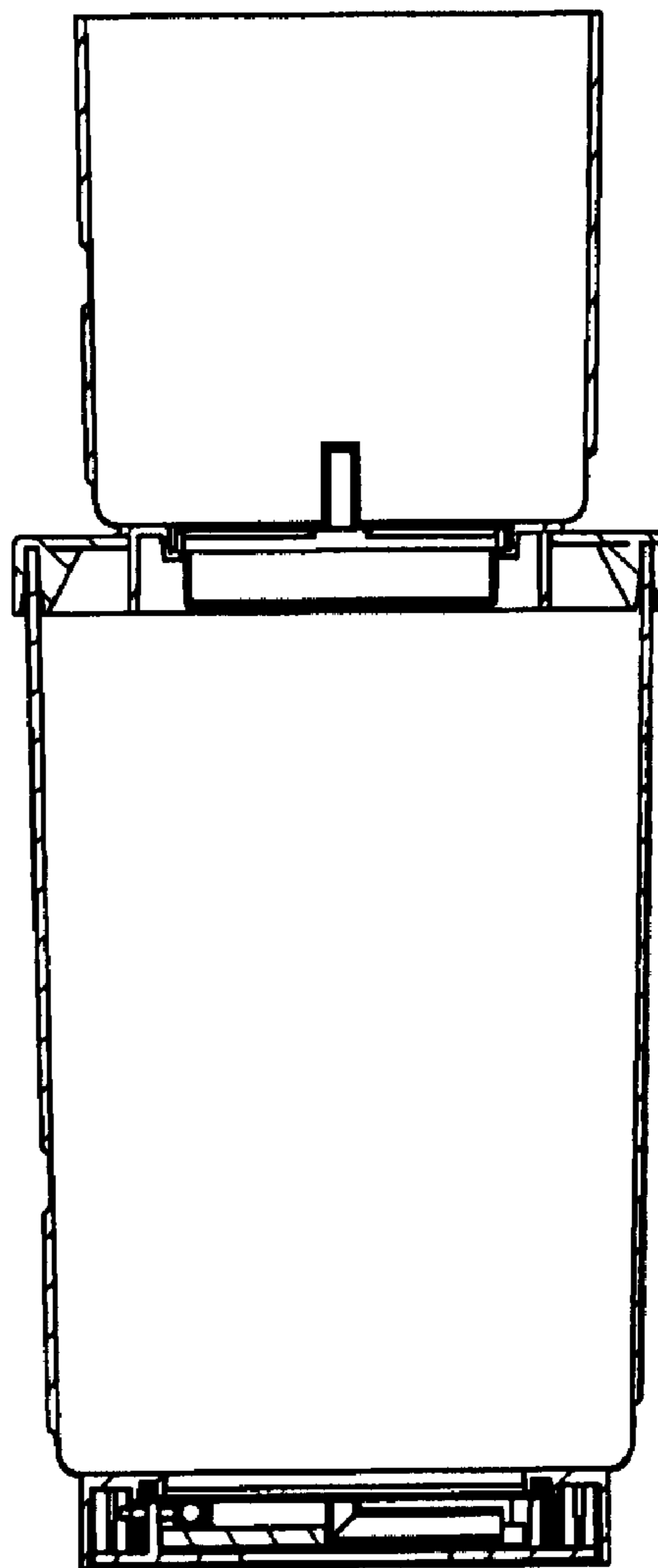


**FIG. 8**





**FIG. 9**



**FIG. 10**

