



US00D556231S

(12) **United States Design Patent**
Kato et al.

(10) **Patent No.:** **US D556,231 S**

(45) **Date of Patent:** **** Nov. 27, 2007**

(54) **SURVEILLANCE TELEVISION CAMERA**

D472,260 S * 3/2003 Higgins et al. D16/203
6,686,952 B1 * 2/2004 Brazier 348/143

(75) Inventors: **Tetsuro Kato**, Nagoya (JP); **Hirokazu Mitsugi**, Nagoya (JP)

* cited by examiner

(73) Assignee: **Elmo Co., Ltd.**, Aichi (JP)

Primary Examiner—Ian Simmons

Assistant Examiner—Wan Laymon

(**) Term: **14 Years**

(74) *Attorney, Agent, or Firm*—Koda & Androlia

(21) Appl. No.: **29/222,167**

(57) **CLAIM**

(22) Filed: **Jan. 26, 2005**

The ornamental design for a surveillance television camera, as shown and described.

(51) **LOC (8) Cl.** **16-01**

(52) **U.S. Cl.** **D16/203; D16/202**

(58) **Field of Classification Search** D16/200–206,
D16/208, 218, 213, 232; 348/143, 151, 373–376;
396/427, 535, 536–541

See application file for complete search history.

DESCRIPTION

FIG. 1 is a front elevational view of a surveillance television camera showing our new design;

FIG. 2 is a rear elevational view thereof;

FIG. 3 is a top plan view thereof;

FIG. 4 is a bottom plan view thereof;

FIG. 5 is a right side elevational view thereof; and,

FIG. 6 is a left side elevational view thereof.

The broken lines in the figures are for illustrative purposes only and form no part of the claimed design.

(56) **References Cited**

U.S. PATENT DOCUMENTS

3,732,368	A *	5/1973	Mahlab	348/151
4,920,367	A *	4/1990	Pagano	396/427
5,940,122	A *	8/1999	Kizawa et al.	348/151
6,259,476	B1 *	7/2001	Greene	348/151
6,268,882	B1 *	7/2001	Elberbaum	348/151

1 Claim, 6 Drawing Sheets

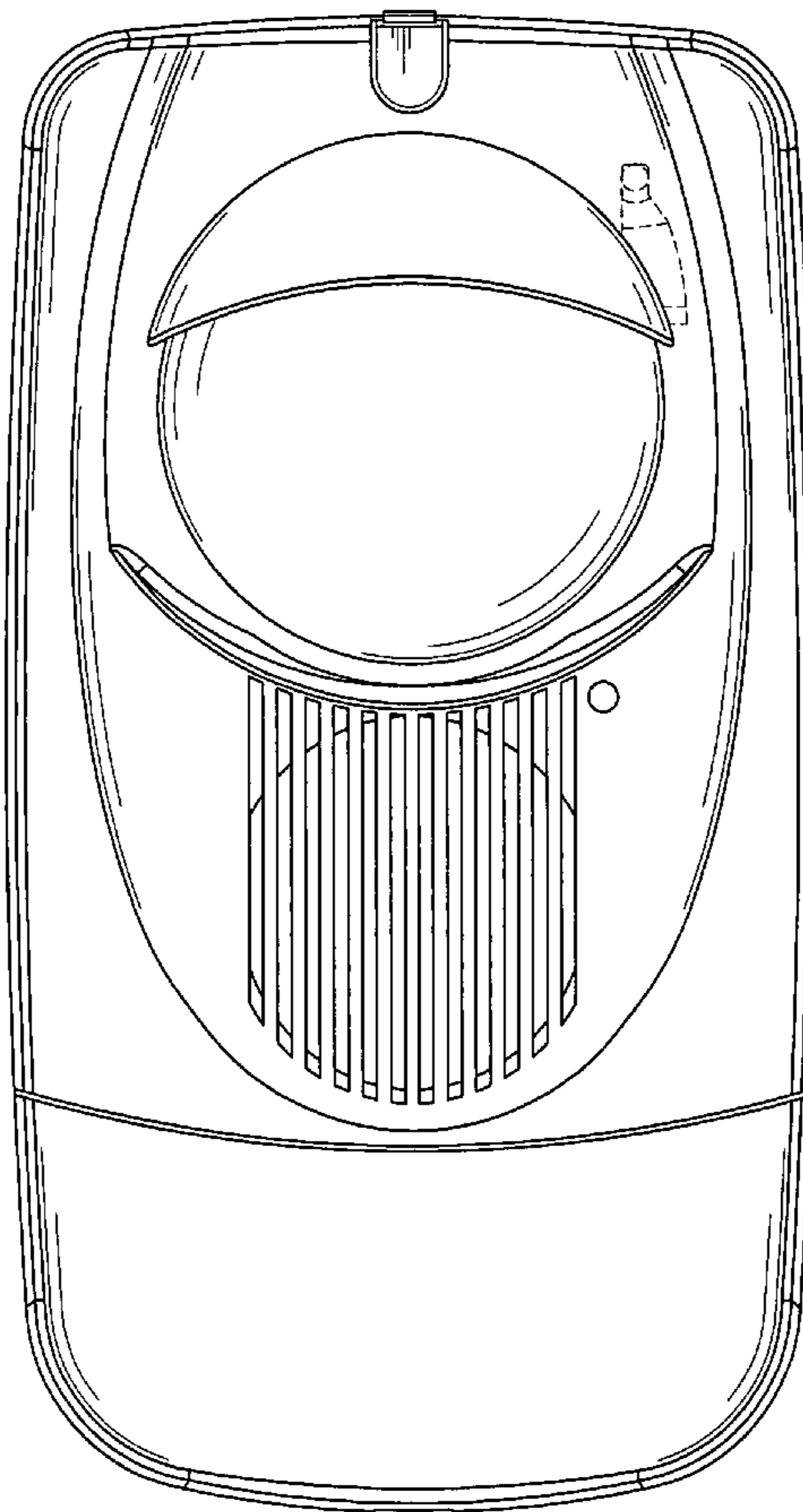

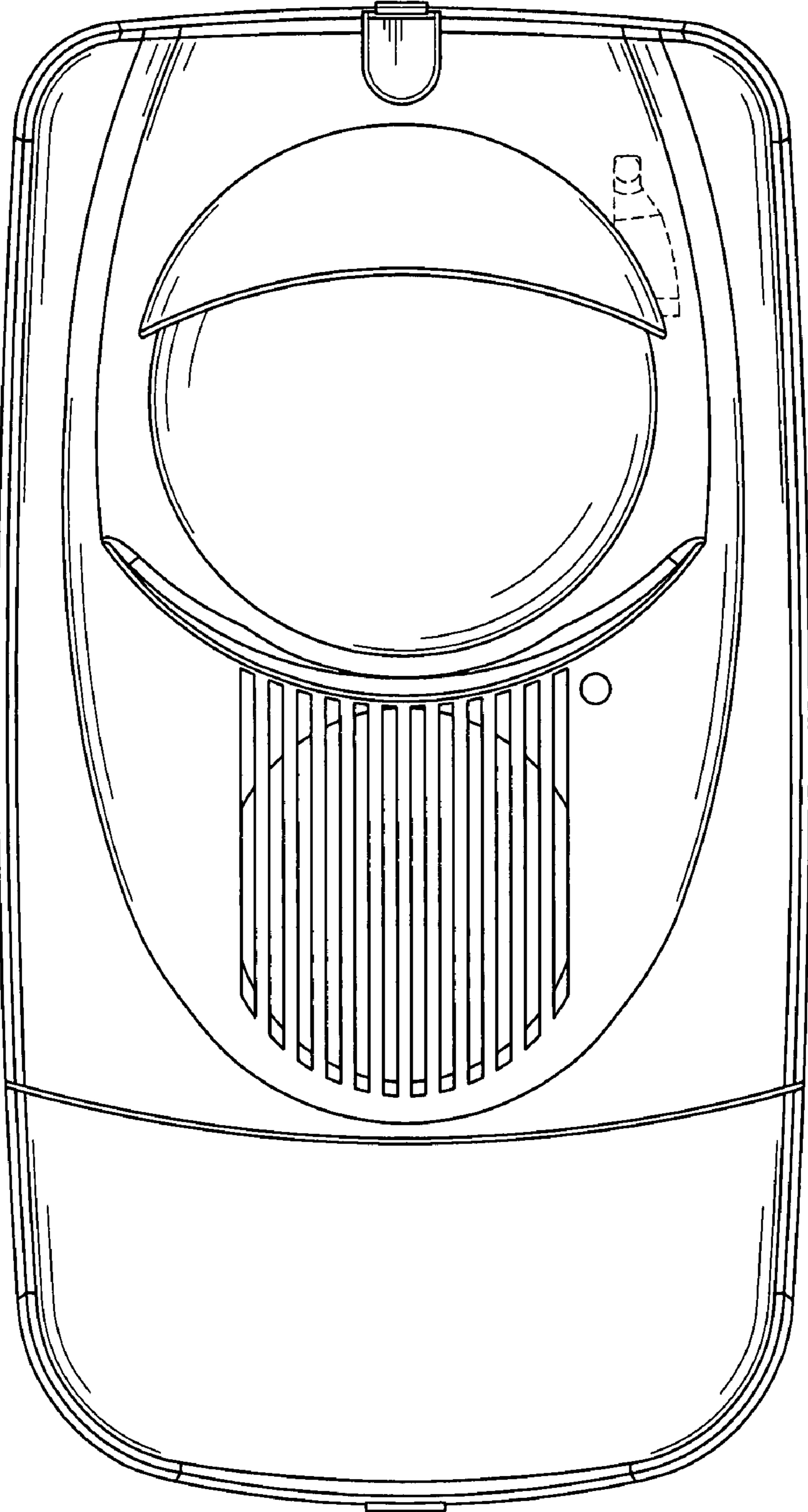

FIG. 1

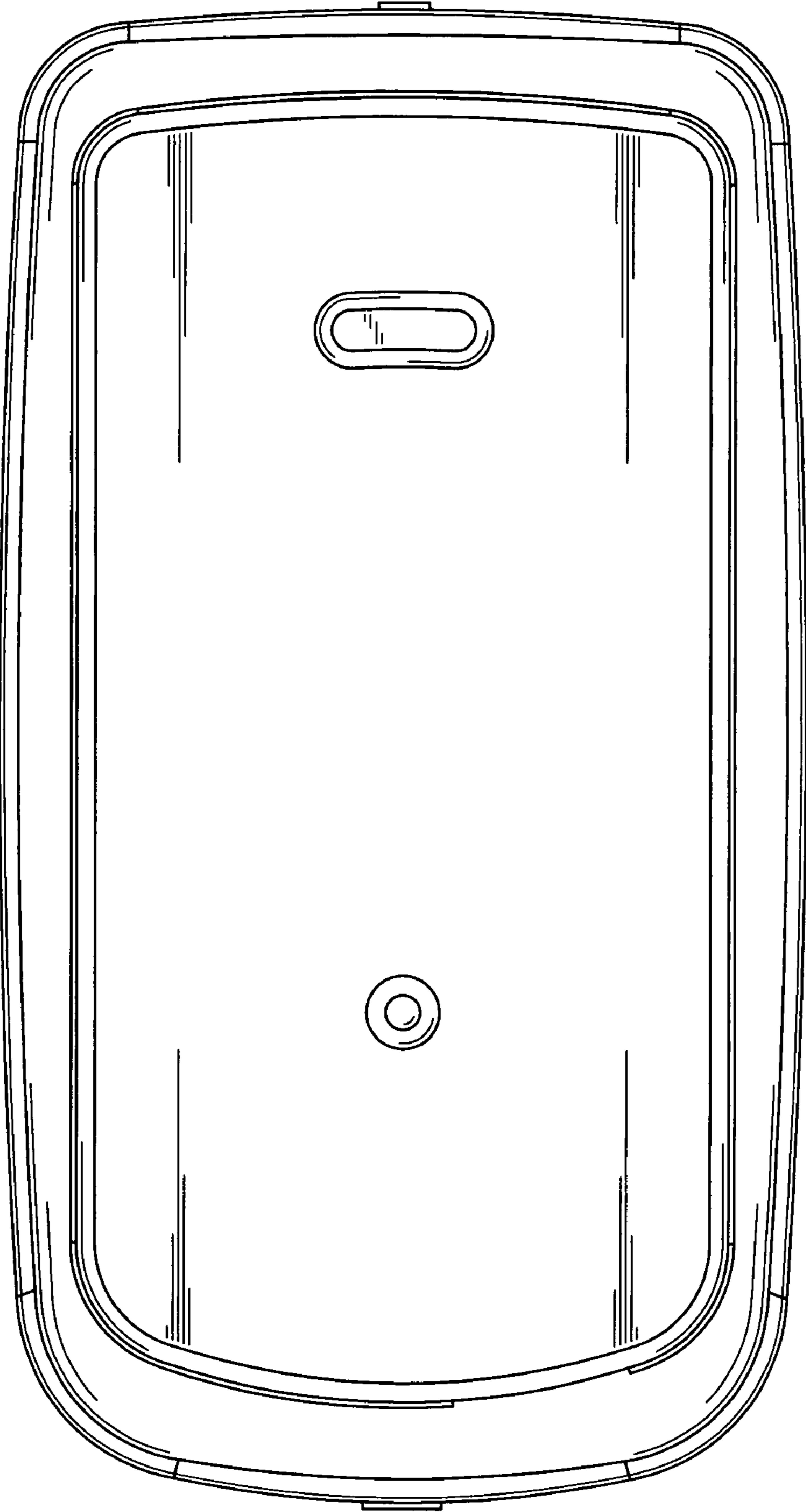

FIG. 2

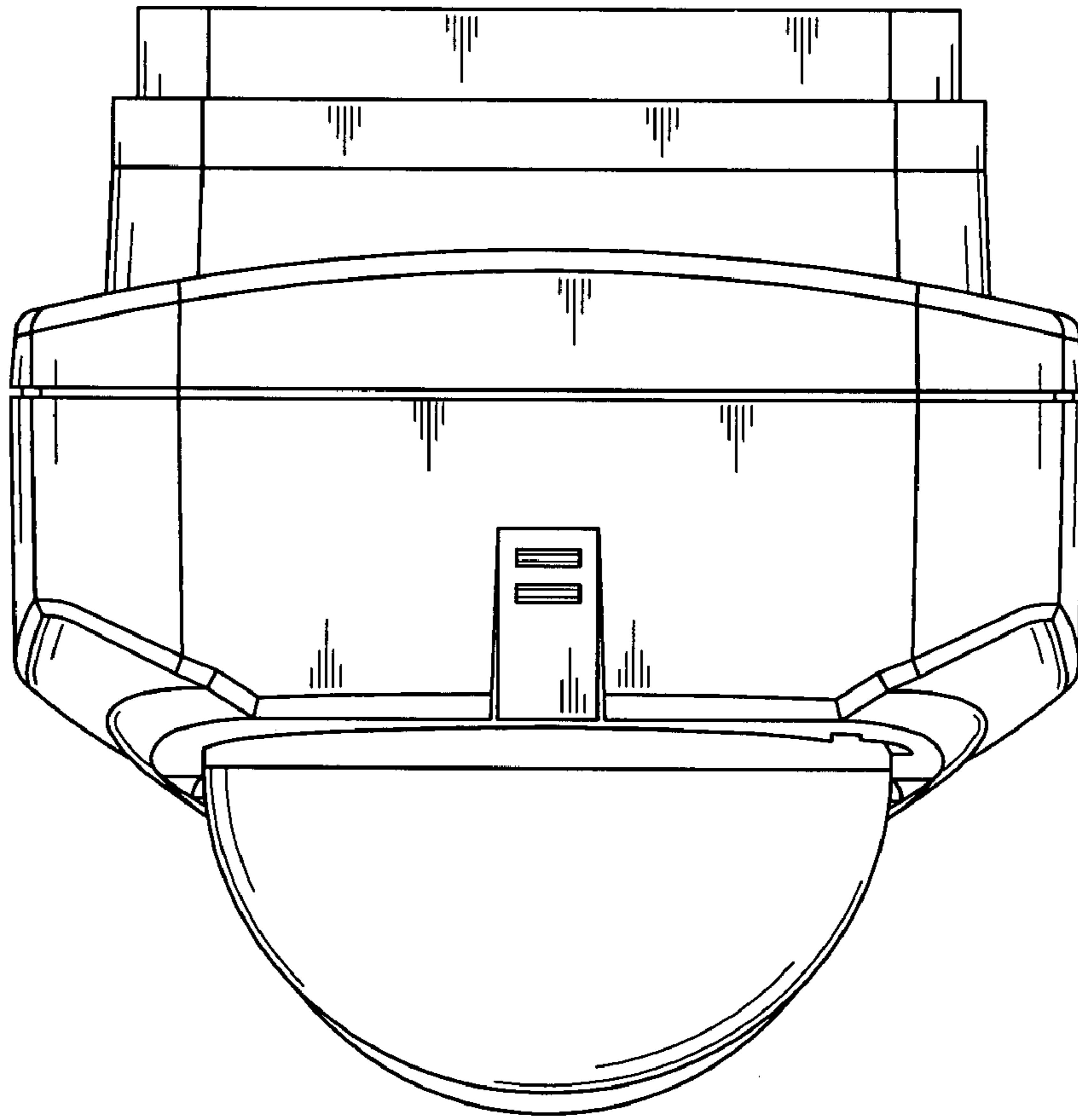

FIG. 3

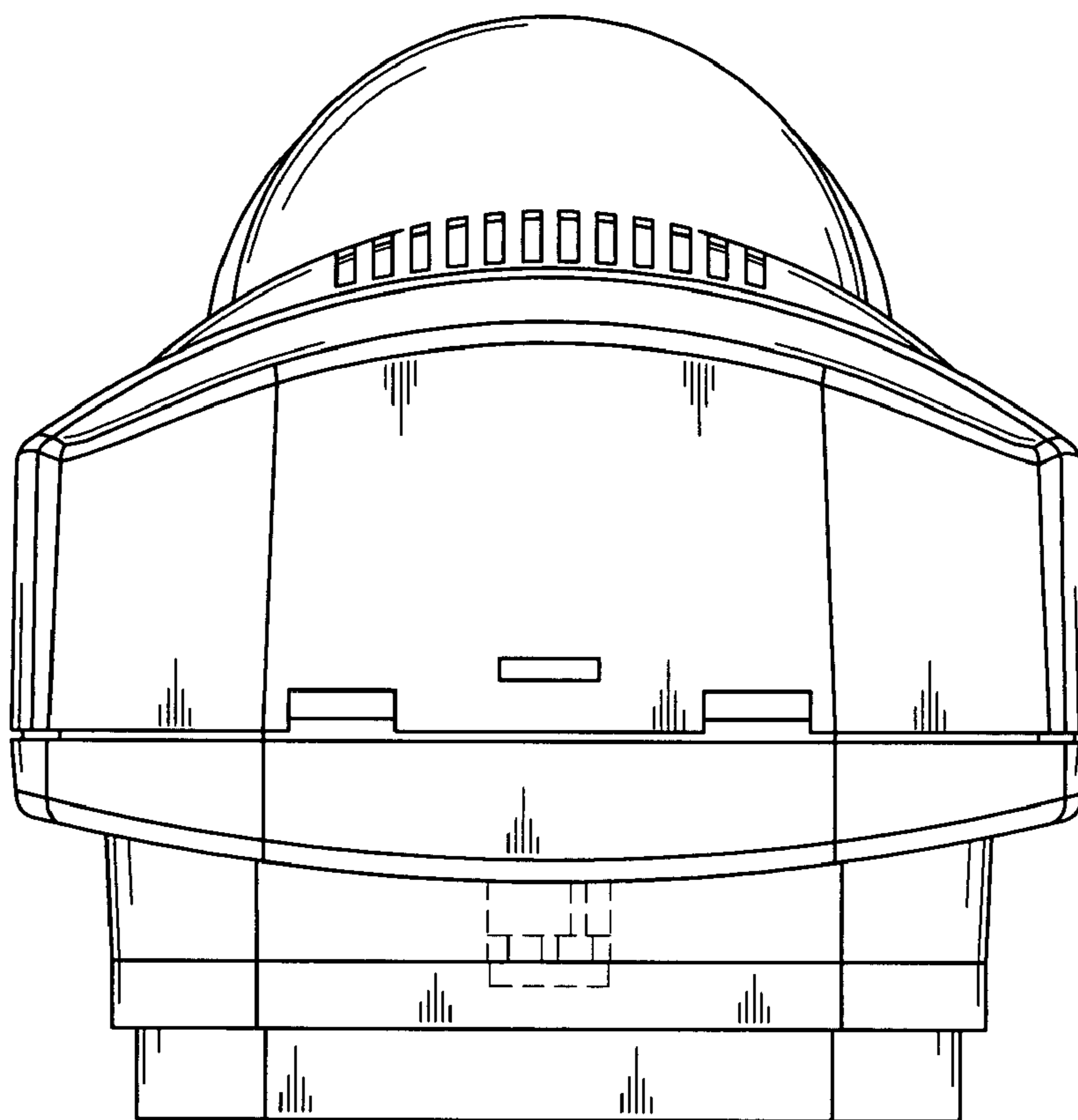

FIG. 4

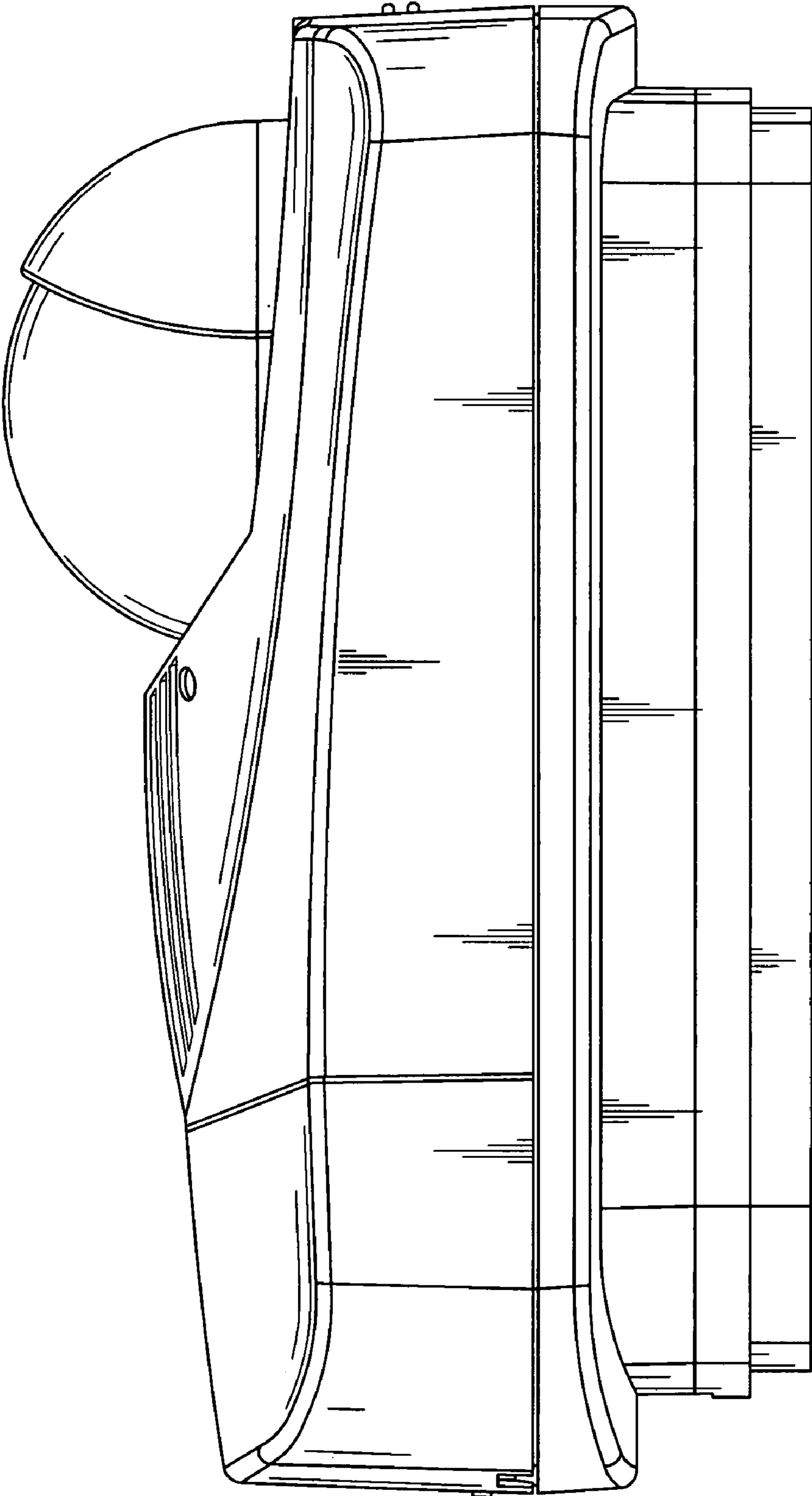

FIG. 5

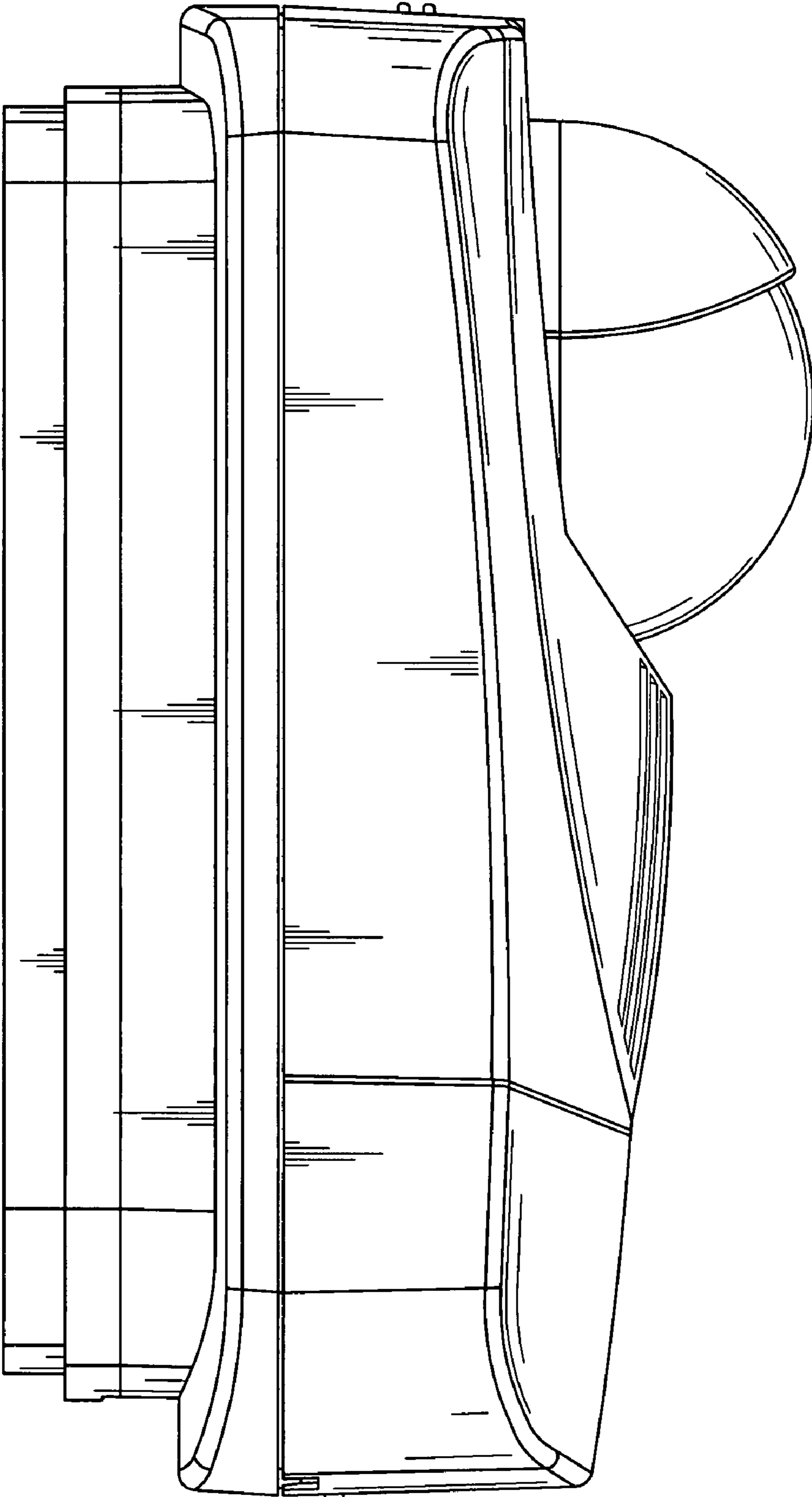

FIG. 6