



US00D556215S

(12) **United States Design Patent** (10) **Patent No.:** **US D556,215 S**
Saunders et al. (45) **Date of Patent:** **** Nov. 27, 2007**

(54) **HANDHELD VACUUM PUMP UNIT**
(75) Inventors: **Craig M. Saunders**, Rocky River, OH (US); **Marc L. Vitantonio**, South Russell, OH (US); **Giles Douglas Powell, Jr.**, Richmond, VA (US); **Paul J. Tretina**, Glen Allen, VA (US)

D467,593 S * 12/2002 Williams D15/7
D467,941 S * 12/2002 Duncan D15/7
D467,942 S * 12/2002 Duncan D15/7
D525,823 S 8/2006 Littmann

* cited by examiner

Primary Examiner—Ralf Seifert
(74) *Attorney, Agent, or Firm*—Greenberg Traurig LLP; Paul F. McQuade; James Goepel

(73) Assignee: **Alcoa Inc.**, Pittsburgh, PA (US)

(**) Term: **14 Years**

(57) **CLAIM**

(21) Appl. No.: **29/276,823**

The ornamental design for a handheld vacuum pump unit, as shown and described.

(22) Filed: **Feb. 7, 2007**

(51) **LOC (8) Cl.** **15-02**

DESCRIPTION

(52) **U.S. Cl.** **D15/7**

FIG. 1 is a perspective view of the handheld vacuum pump unit, showing an embodiment of the present design;

(58) **Field of Classification Search** D15/7-9;

FIG. 2 is a bottom plan view of the embodiment of the present design illustrated in FIG. 1;

D23/232, 231; 417/359, 415-416, 410.1, 417/321, 265, 405

See application file for complete search history.

FIG. 3 is a top plan view of the embodiment of the present design illustrated in FIG. 1;

(56) **References Cited**

U.S. PATENT DOCUMENTS

D248,396 S * 7/1978 Sendak D15/7
D336,090 S * 6/1993 Lacorazza D15/7
D348,677 S * 7/1994 Phillips et al. D15/7
D358,397 S * 5/1995 Phillips et al. D15/7
D405,097 S * 2/1999 Wong D15/7
D415,500 S * 10/1999 Poon D15/7
D425,912 S * 5/2000 Poon D15/7
D451,521 S * 12/2001 Poon D15/7
D464,976 S * 10/2002 Krieger et al. D15/9
D467,048 S 12/2002 Masaki

FIG. 4 is a right elevation view of the embodiment of the present design illustrated in FIG. 1;

FIG. 5 is a left elevation view of the embodiment of the present design illustrated in FIG. 1;

FIG. 6 is a front elevation view of the embodiment of the present design illustrated in FIG. 1; and,

FIG. 7 is a rear elevation view of the embodiment of the present design illustrated in FIG. 1.

1 Claim, 5 Drawing Sheets

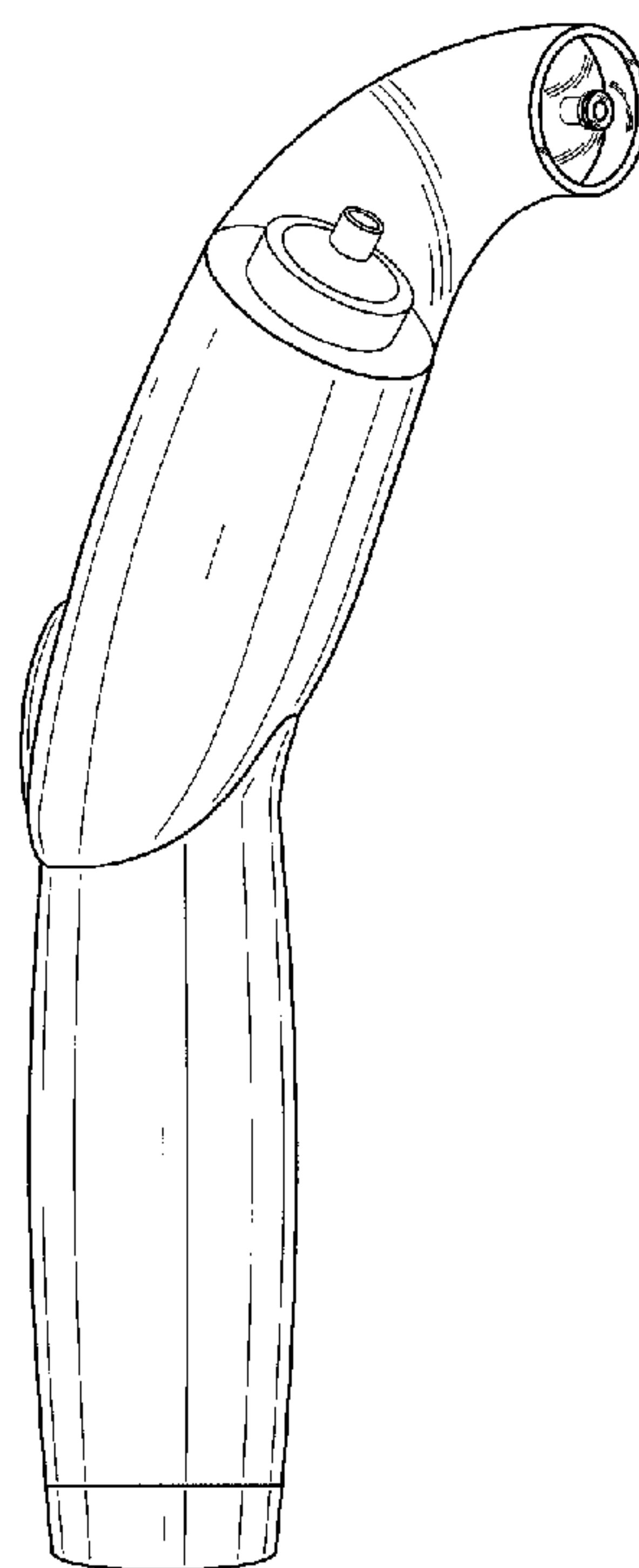

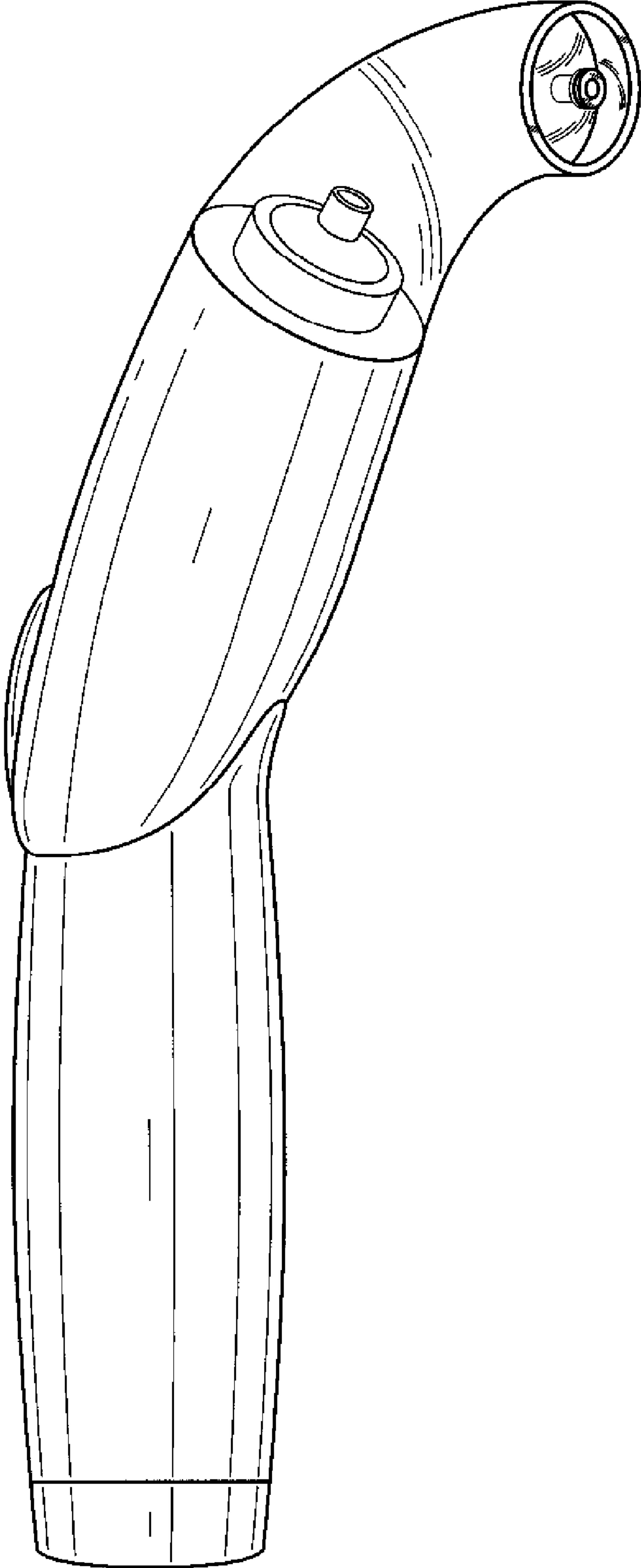

FIG. 1

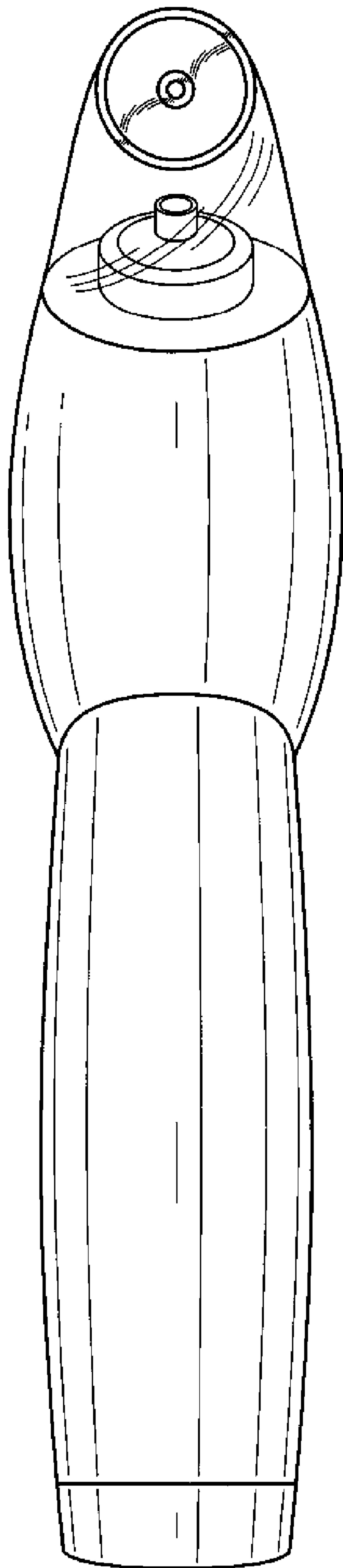

FIG. 2

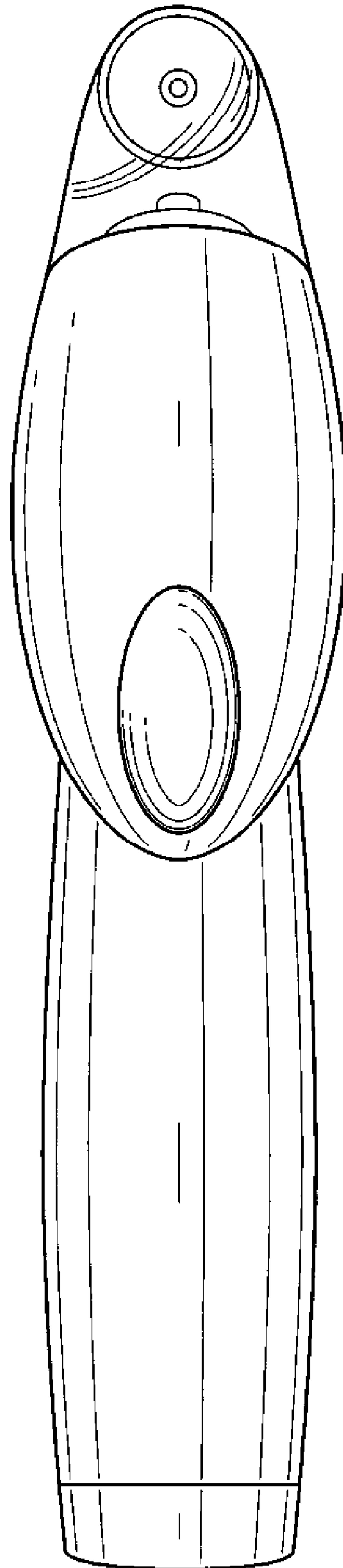

FIG. 3

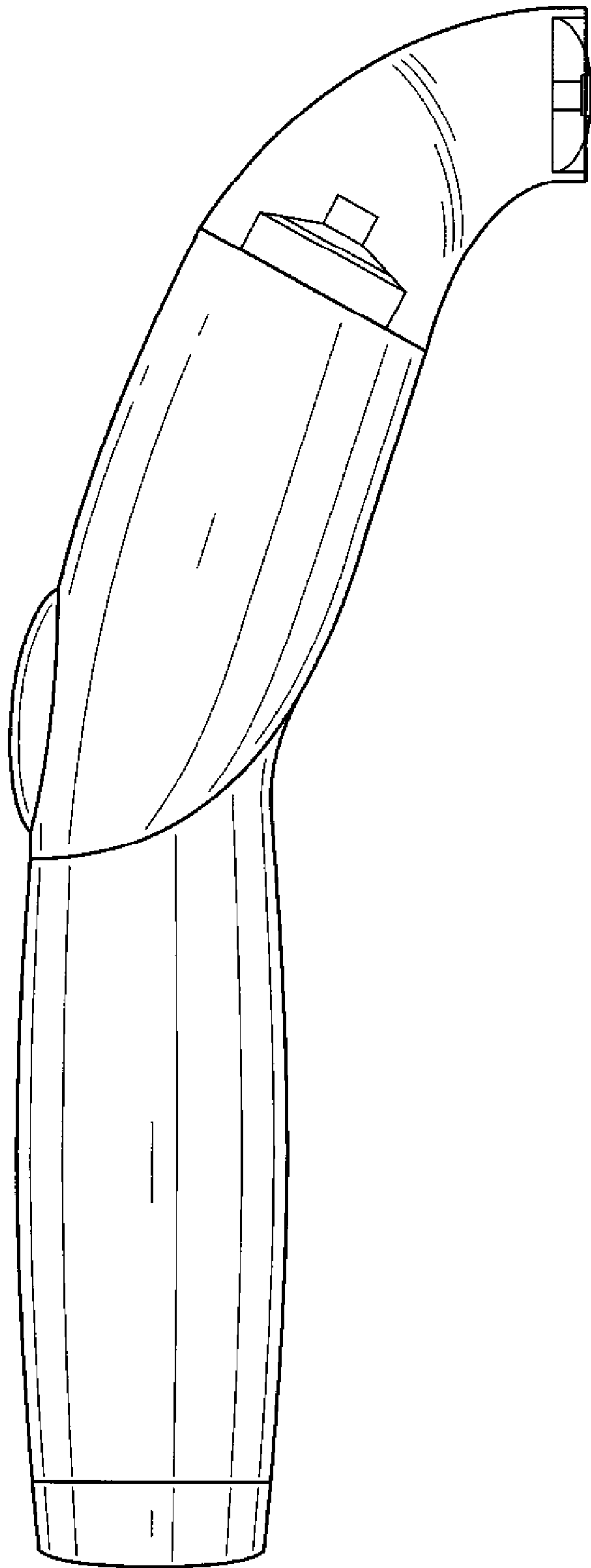

FIG. 4



FIG. 5

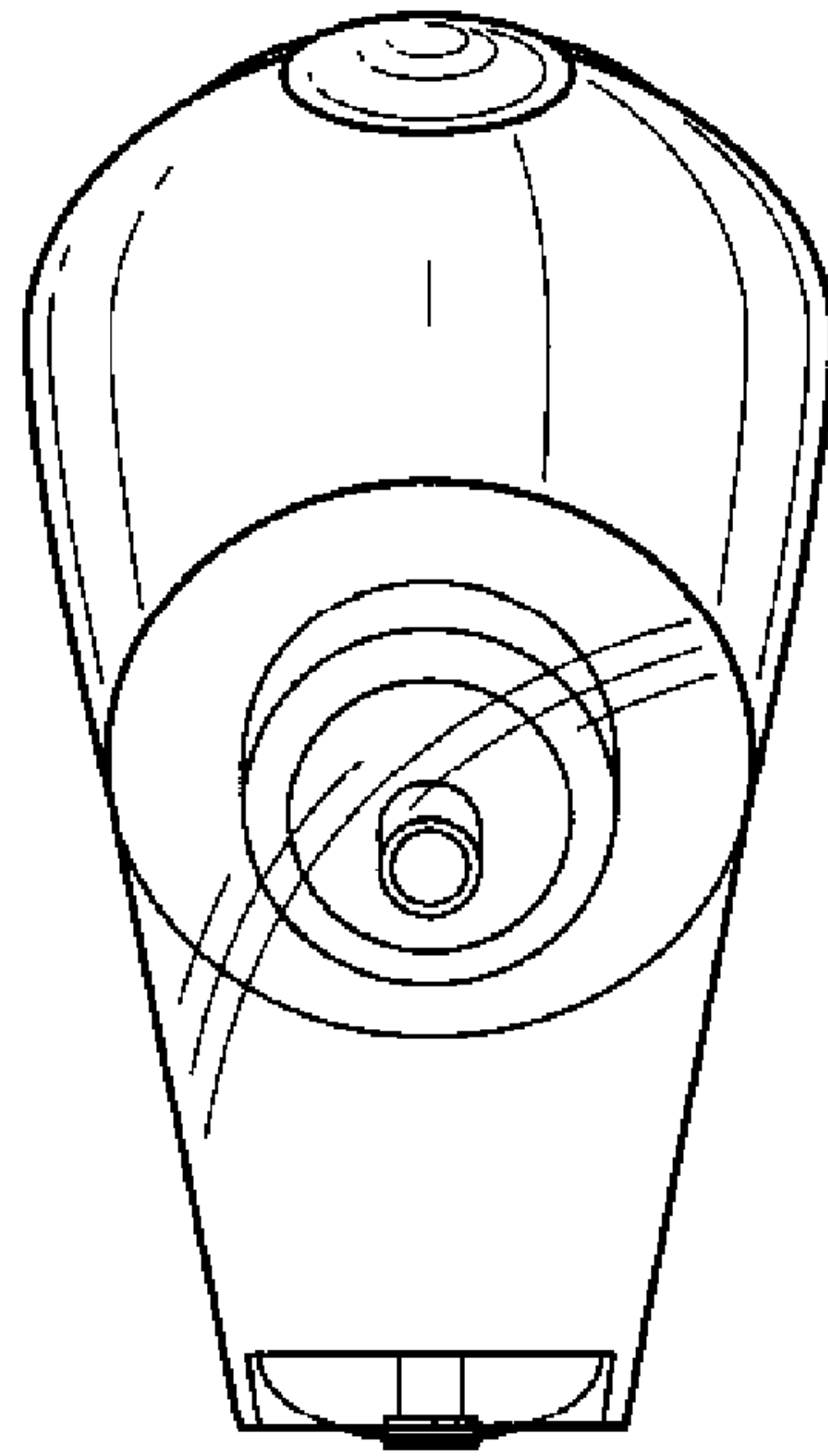

FIG. 6

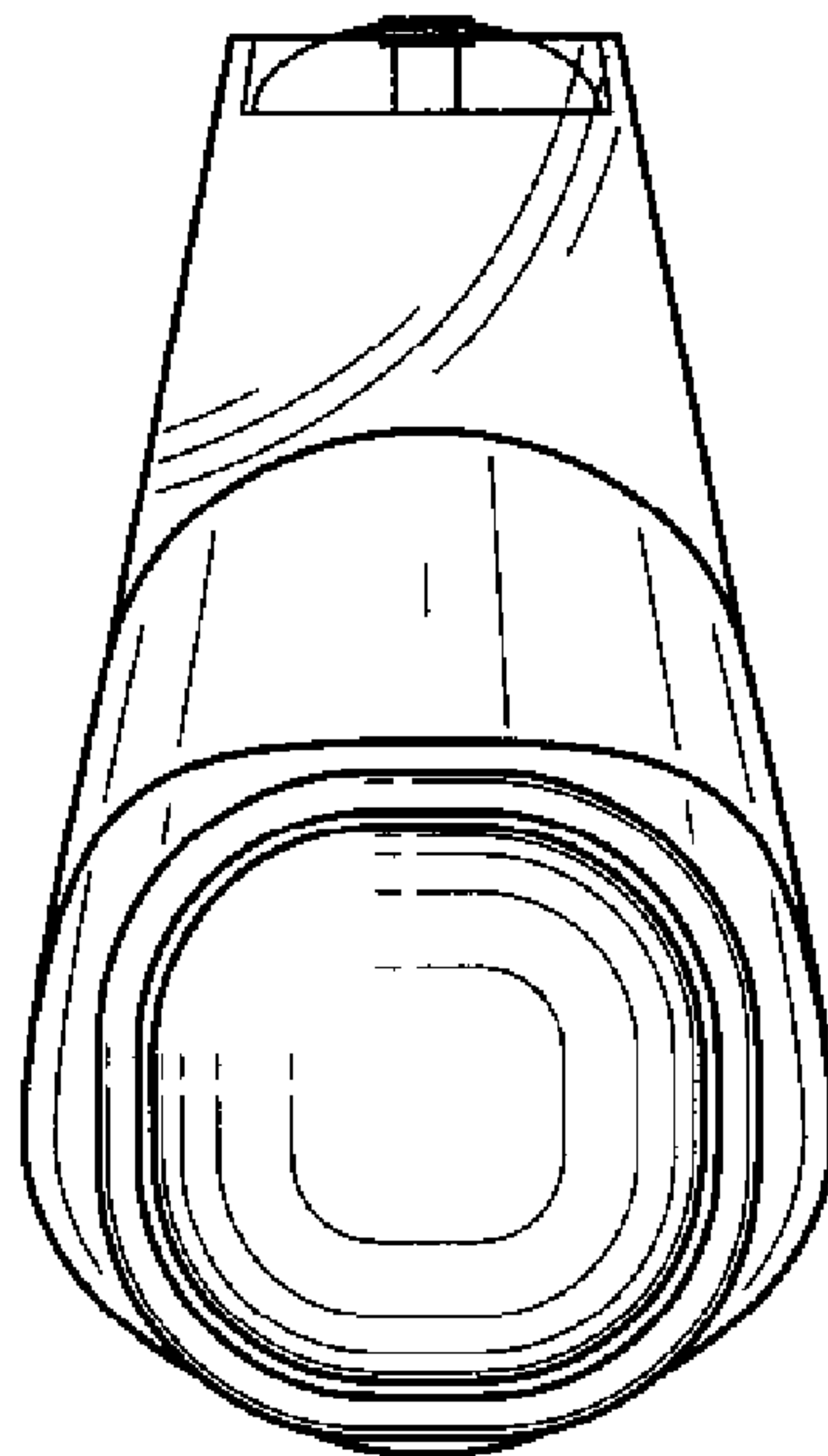

FIG. 7