

US00D556162S

(12) **United States Design Patent**  
**Tragatschnig**

(10) **Patent No.:** **US D556,162 S**

(45) **Date of Patent:** **\*\* Nov. 27, 2007**

(54) **DVD PLAYER**

(75) Inventor: **Joerg Tragatschnig**, Zell am See (AT)

(73) Assignee: **Eton Corporation**, Palo Alto, CA (US)

(\*\*) Term: **14 Years**

(21) Appl. No.: **29/251,272**

(22) Filed: **Jan. 4, 2006**

(51) **LOC (8) Cl.** ..... **14-01**

(52) **U.S. Cl.** ..... **D14/136**

(58) **Field of Classification Search** ..... D14/135–136,  
D14/156–157, 160–165, 167–168, 197–198,  
D14/188; 360/99.02, 99.07; 369/75.11,  
369/75.21, 77.21, 77.11; 720/612, 619, 647,  
720/655; 455/344, 347–351  
See application file for complete search history.

(56) **References Cited**

**U.S. PATENT DOCUMENTS**

4,181,823	A *	1/1980	DeLamoreaux et al. ....	455/344
4,676,619	A *	6/1987	Woolley .....	455/344
D310,525	S *	9/1990	Camens .....	D14/162
D415,491	S *	10/1999	Yano et al. ....	D14/168
D435,034	S *	12/2000	Tejima .....	D14/168
D512,045	S *	11/2005	Motoishi .....	D14/168

\* cited by examiner

*Primary Examiner*—Nanda Bondade

(74) *Attorney, Agent, or Firm*—Jones Day; Brett Lovejoy

(57) **CLAIM**

The ornamental design for a DVD player, as shown and described.

**DESCRIPTION**

FIG. 1 is a front view of a DVD player in a closed configuration;

FIG. 2 is a left side view thereof, in which the DVD player is in an open configuration;

FIG. 3 is a right side view thereof, in which the DVD player is in an open configuration;

FIG. 4 is rear view thereof, in which the DVD player is in a closed configuration;

FIG. 5 is a top plan view thereof, in which the DVD player is in a closed configuration;

FIG. 6 is a top view thereof, in which the DVD player is in an open configuration;

FIG. 7 is a front perspective view thereof, in which the DVD player is in a closed configuration;

FIG. 8 is a front view of a second embodiment of FIG. 1, in which the DVD player is in closed configuration;

FIG. 9 is a left side view of FIG. 8, in which the DVD player is in an open configuration;

FIG. 10 is a right side view of FIG. 8, in which the DVD player is in an open configuration;

FIG. 11 is a rear view of FIG. 8, in which the DVD player is in a closed configuration;

FIG. 12 is a top view of FIG. 8, in which the DVD player is in a closed configuration;

FIG. 13 is a top view of FIG. 8, in which the DVD player is in an open configuration; and,

FIG. 14 is a front perspective view of FIG. 8, in which the DVD player is in a closed configuration.

The broken line showing on the drawing disclosure is for illustrative purposes only and forms no part of the claimed design.

**1 Claim, 14 Drawing Sheets**

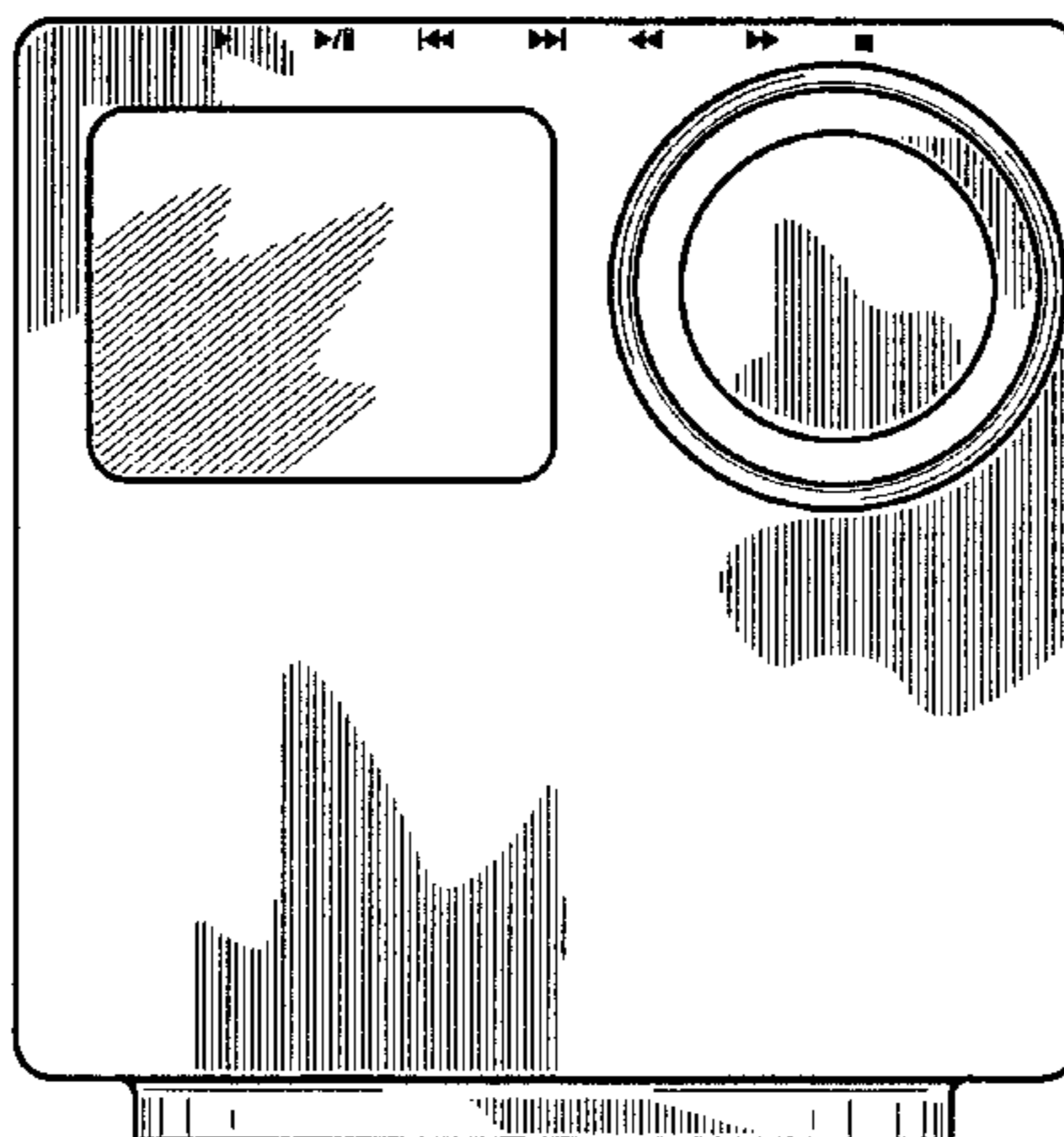

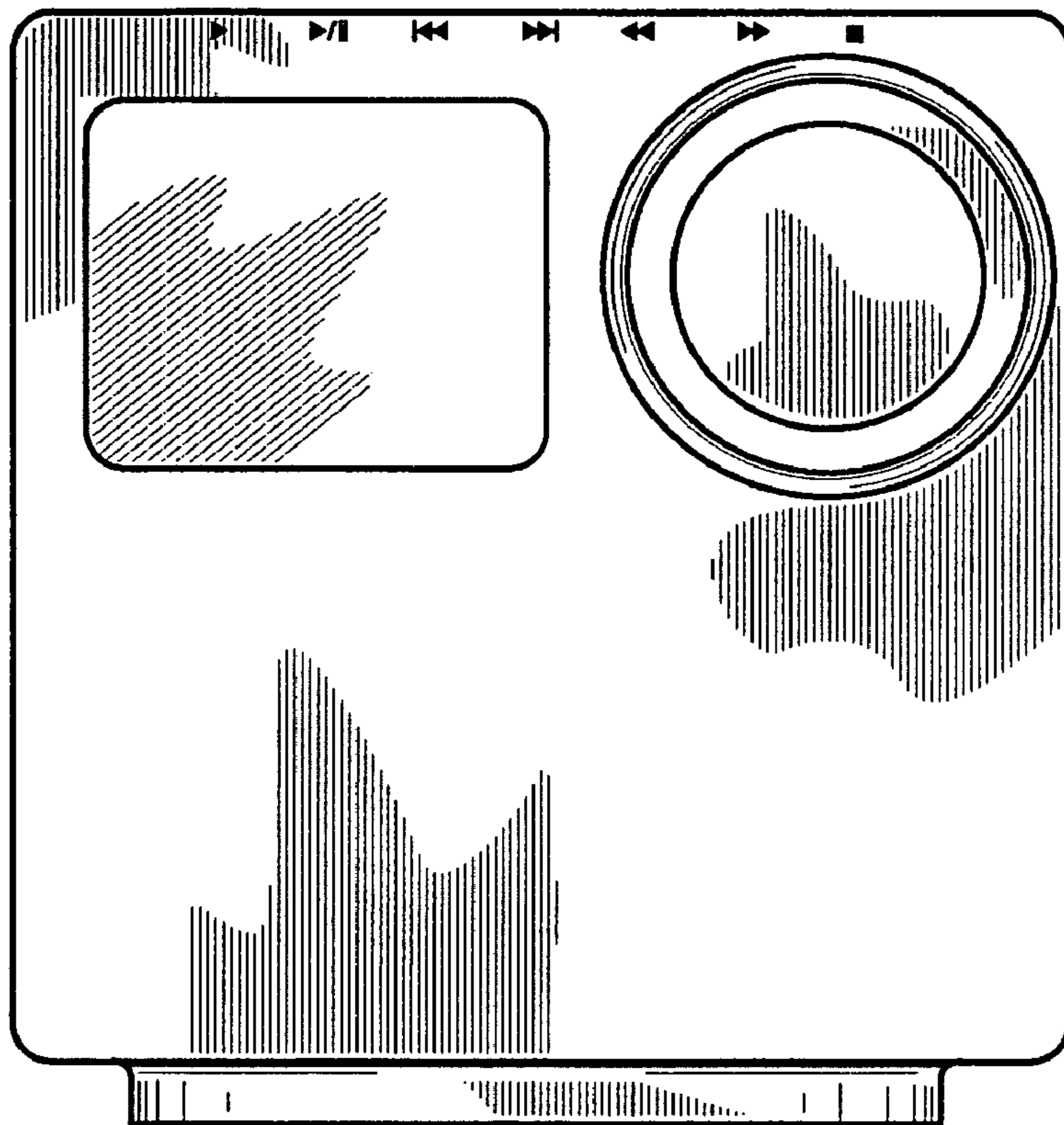

FIG. 1

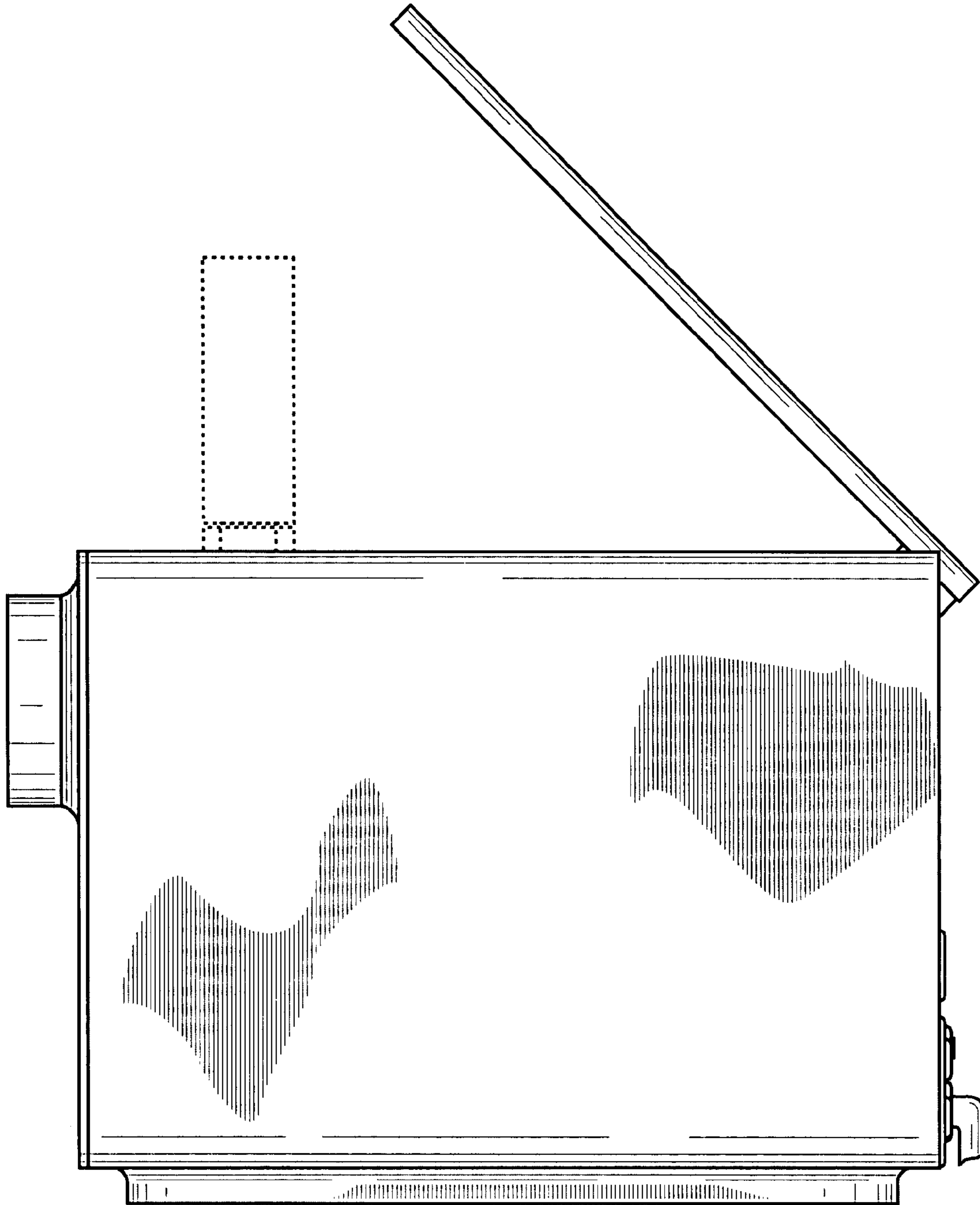

FIG. 2

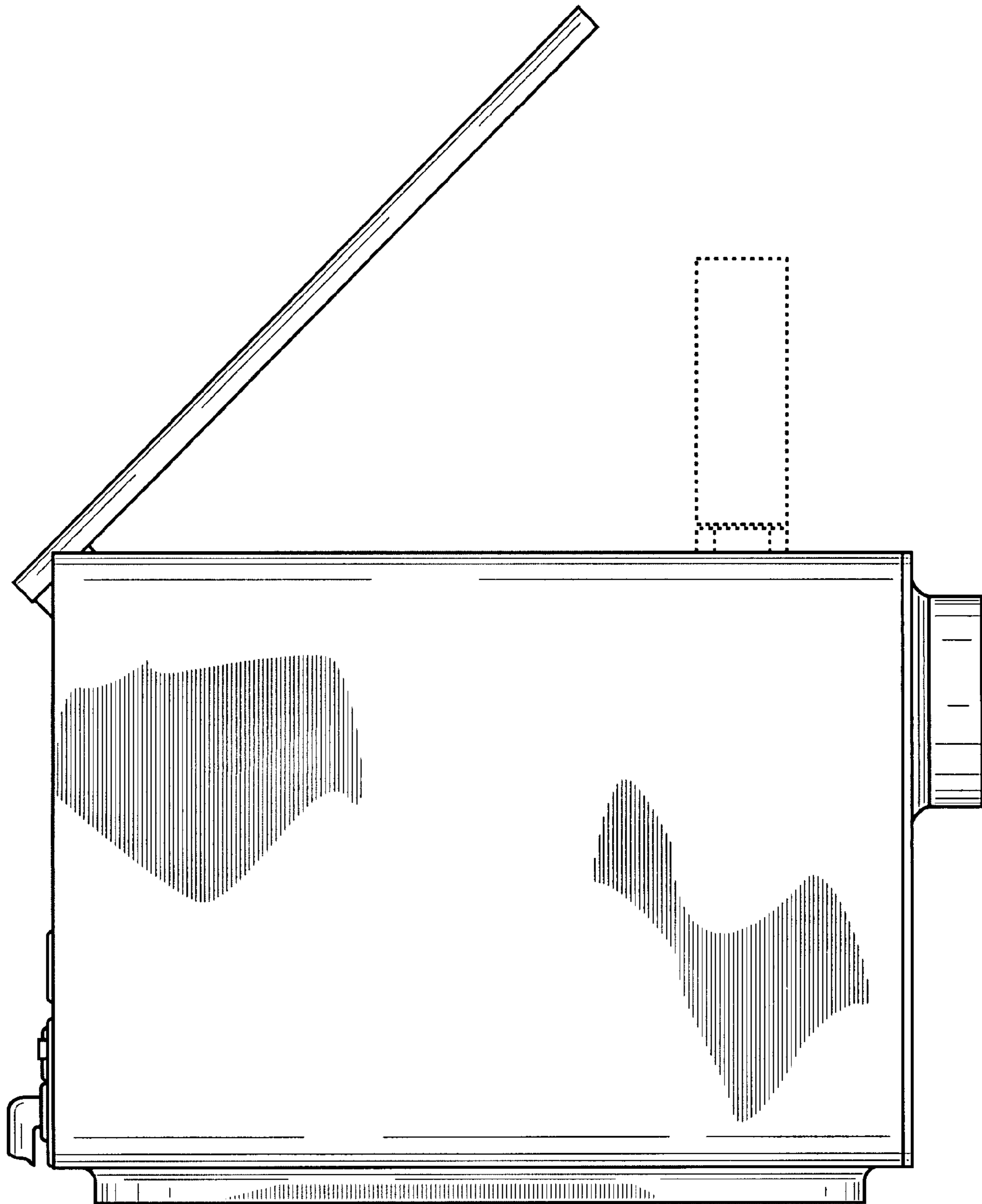

FIG. 3

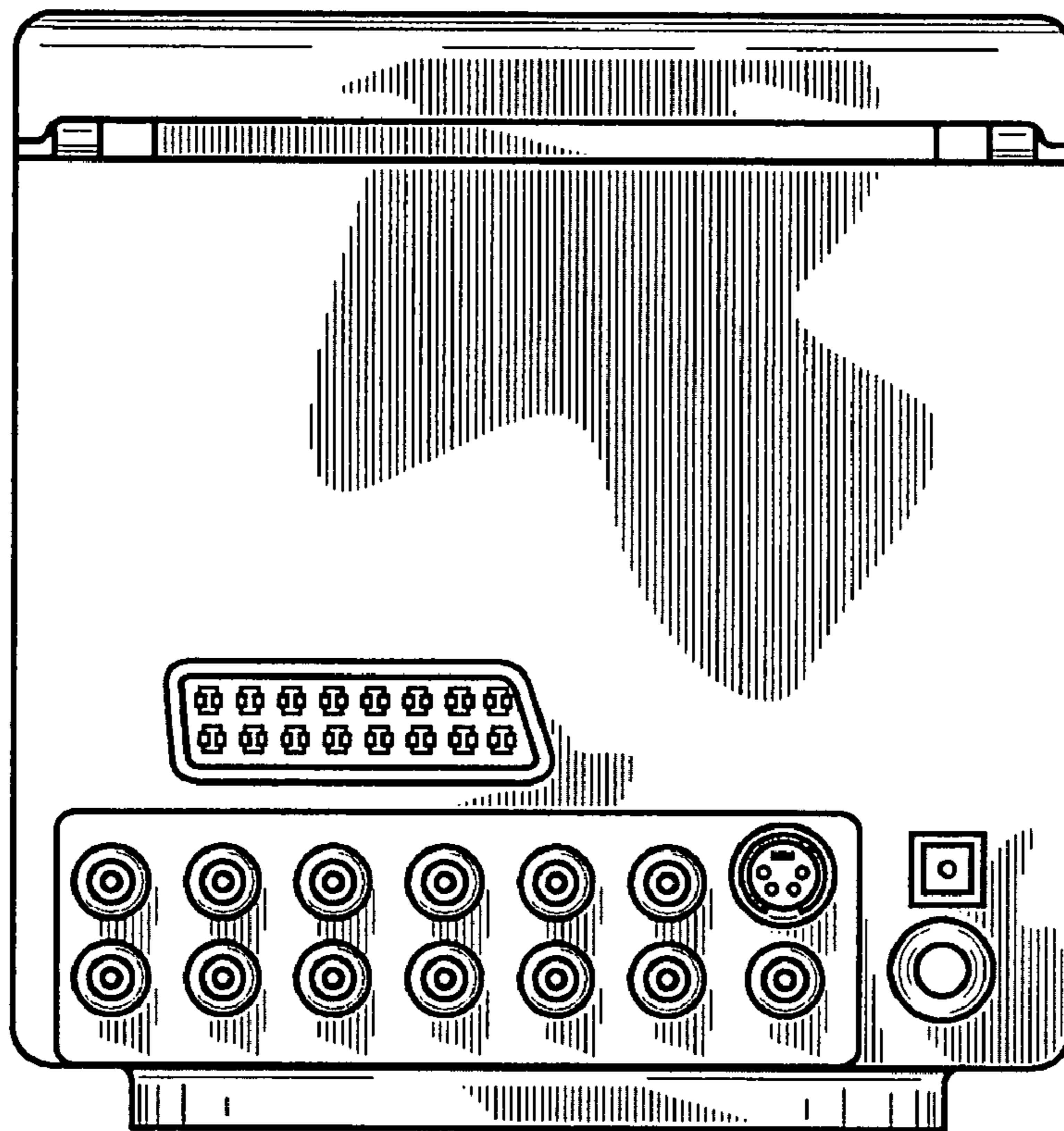

FIG. 4



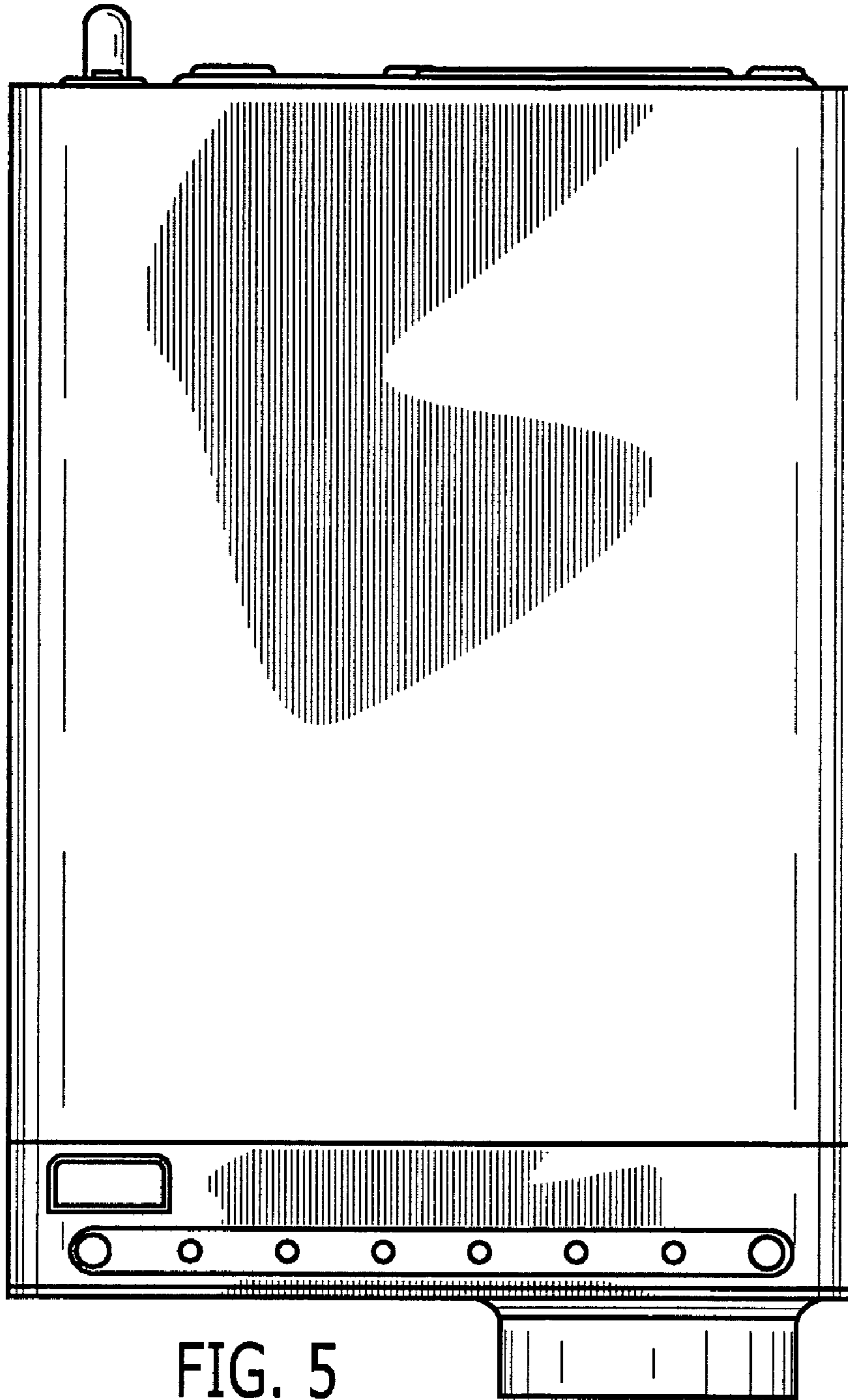

FIG. 5

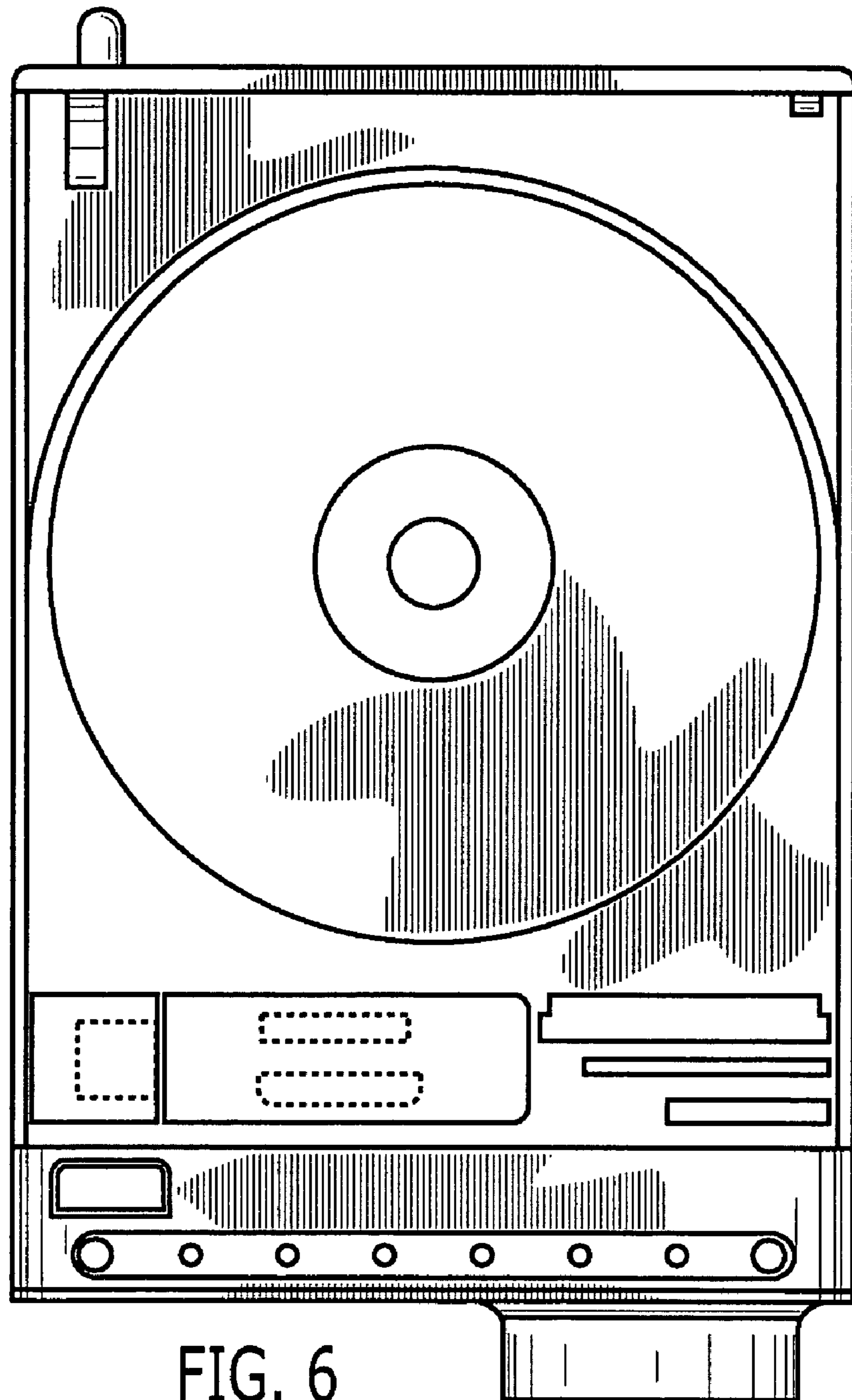

FIG. 6

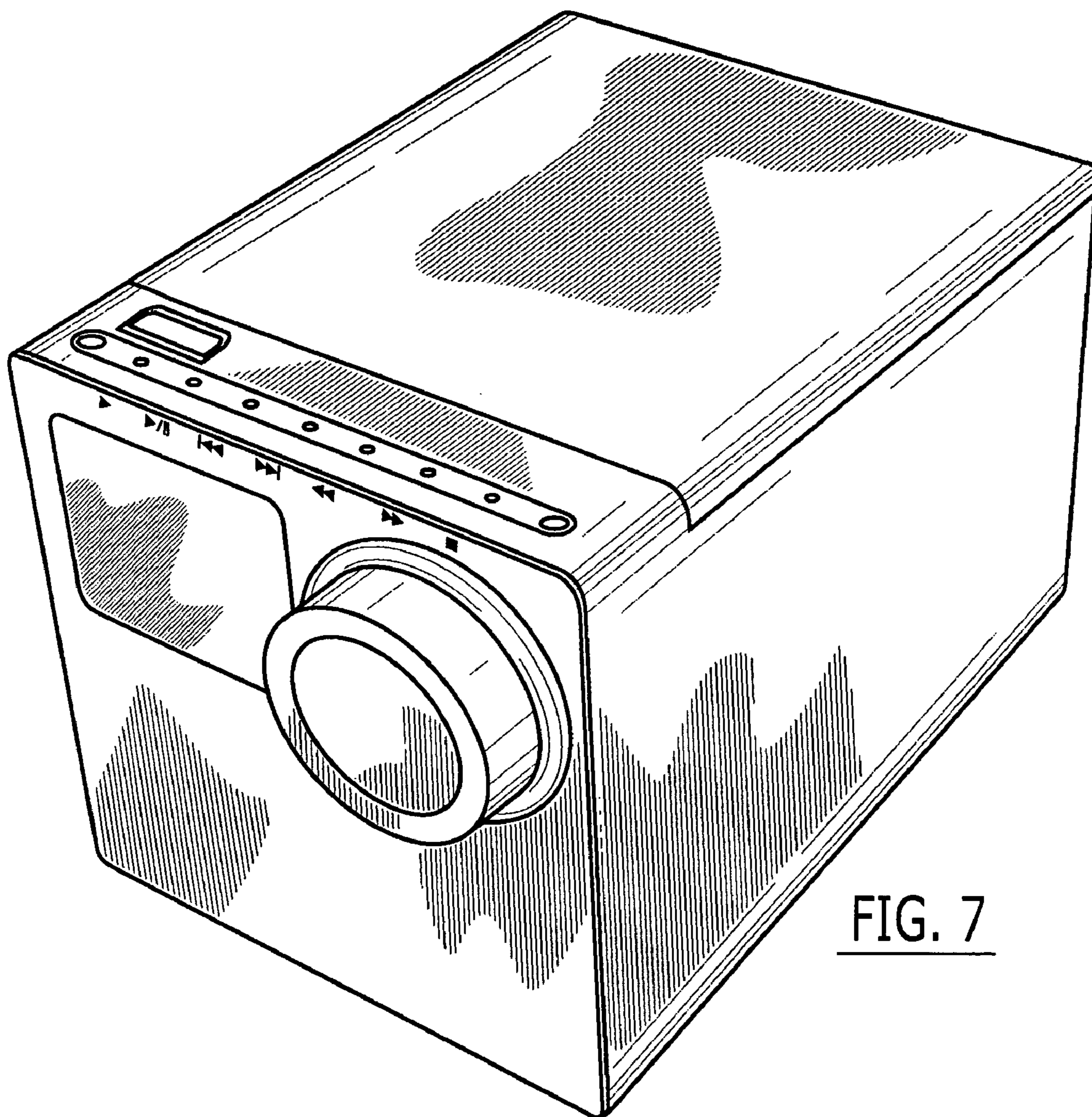

FIG. 7



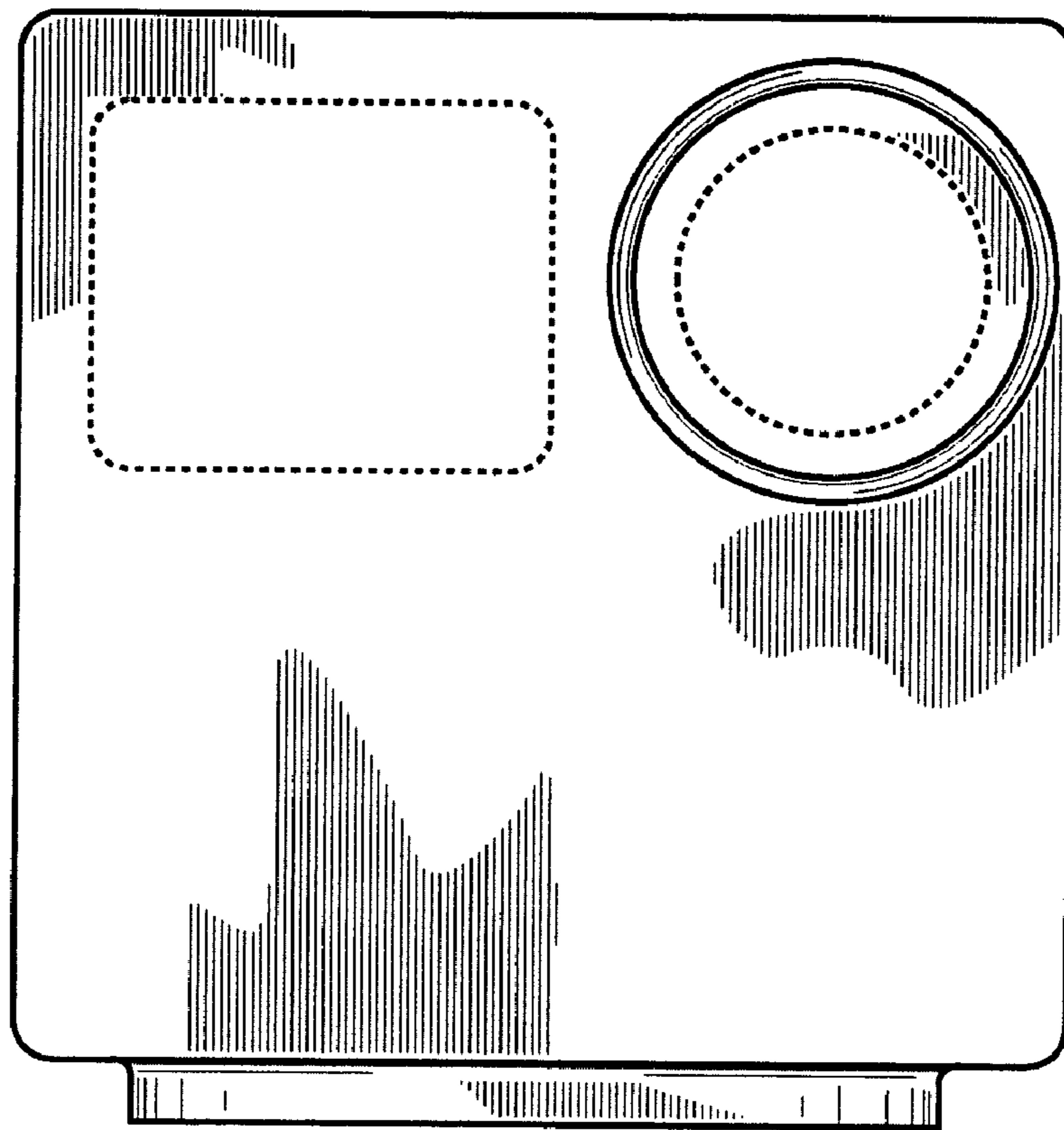

FIG. 8

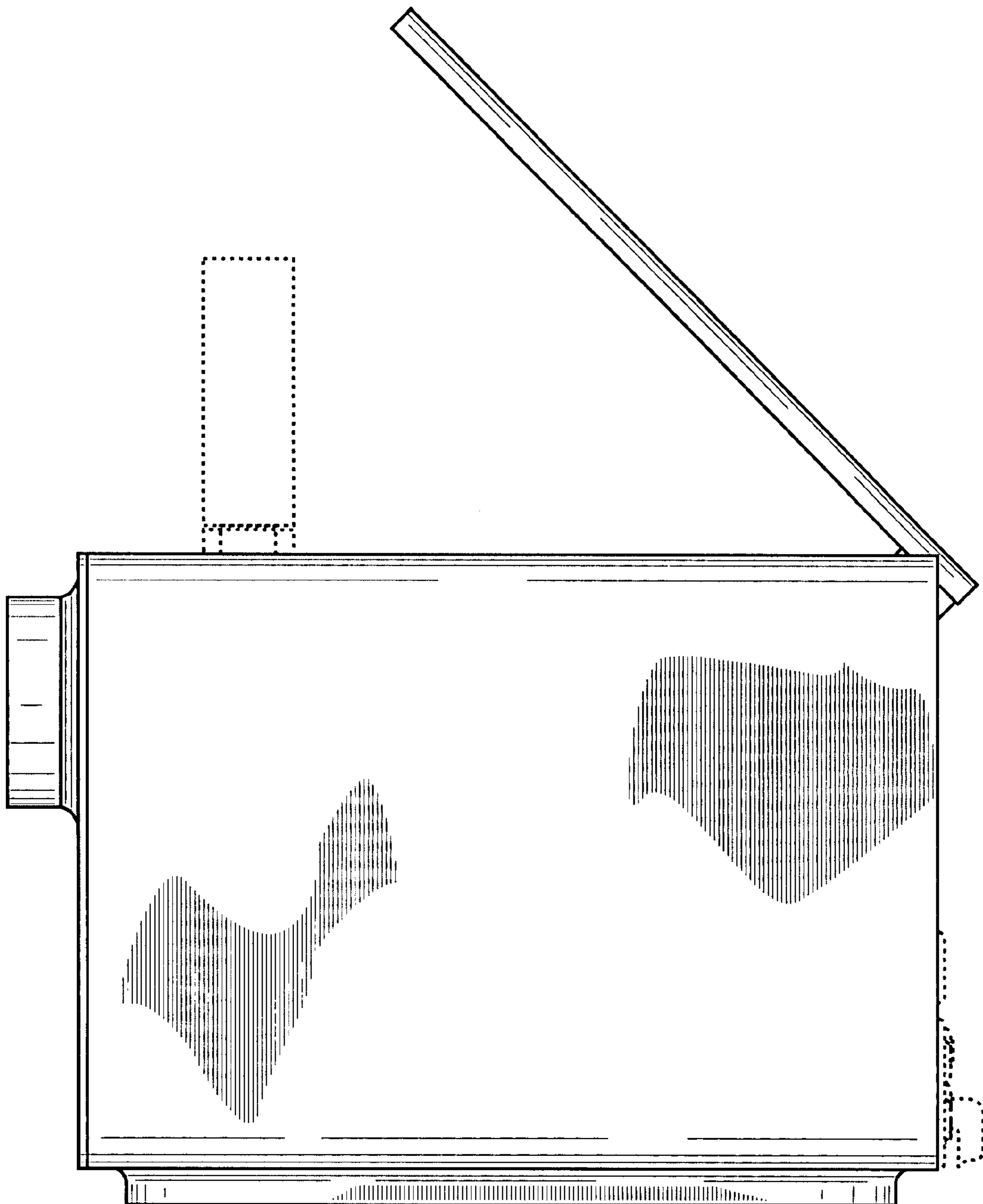

FIG. 9

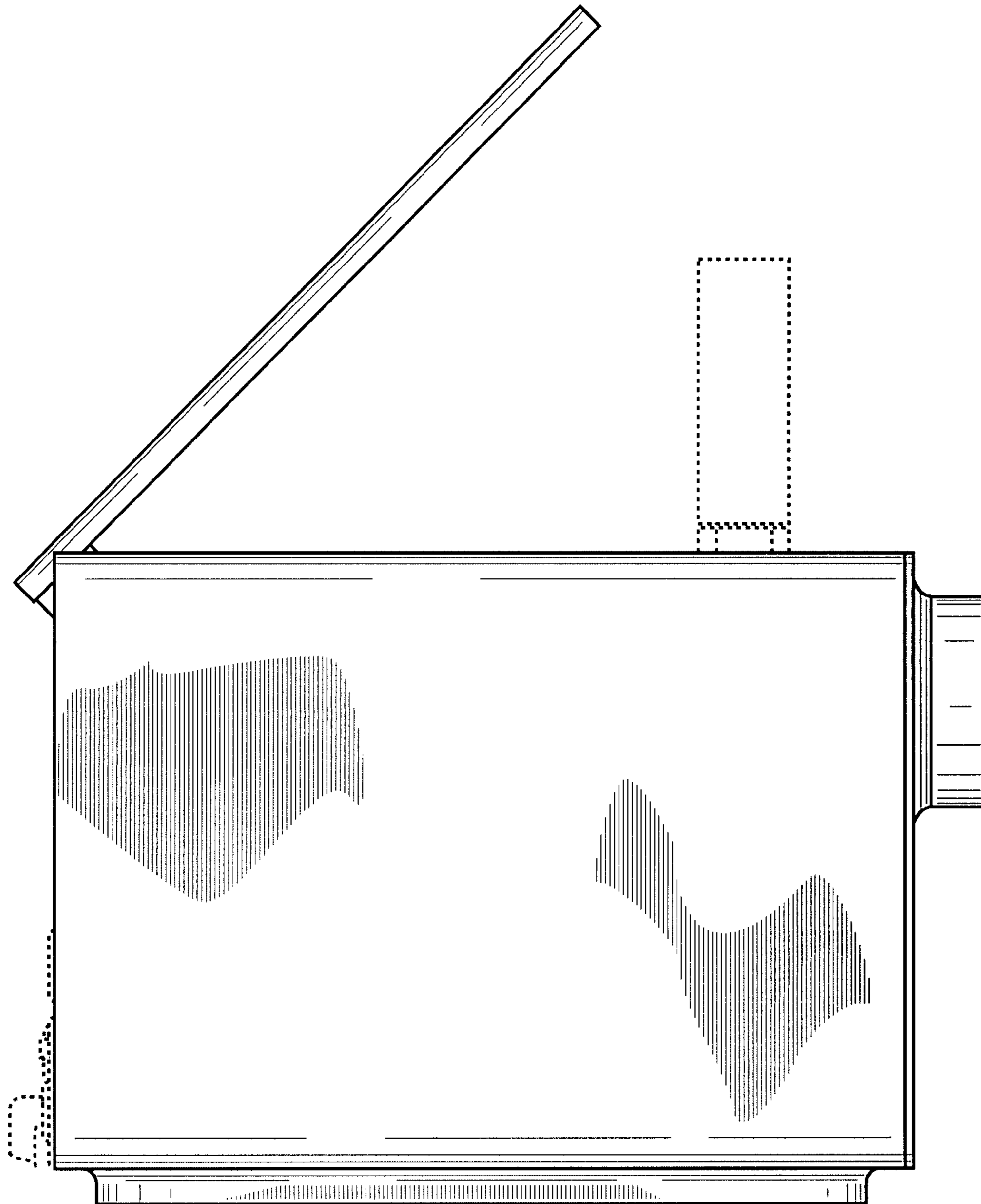

FIG. 10

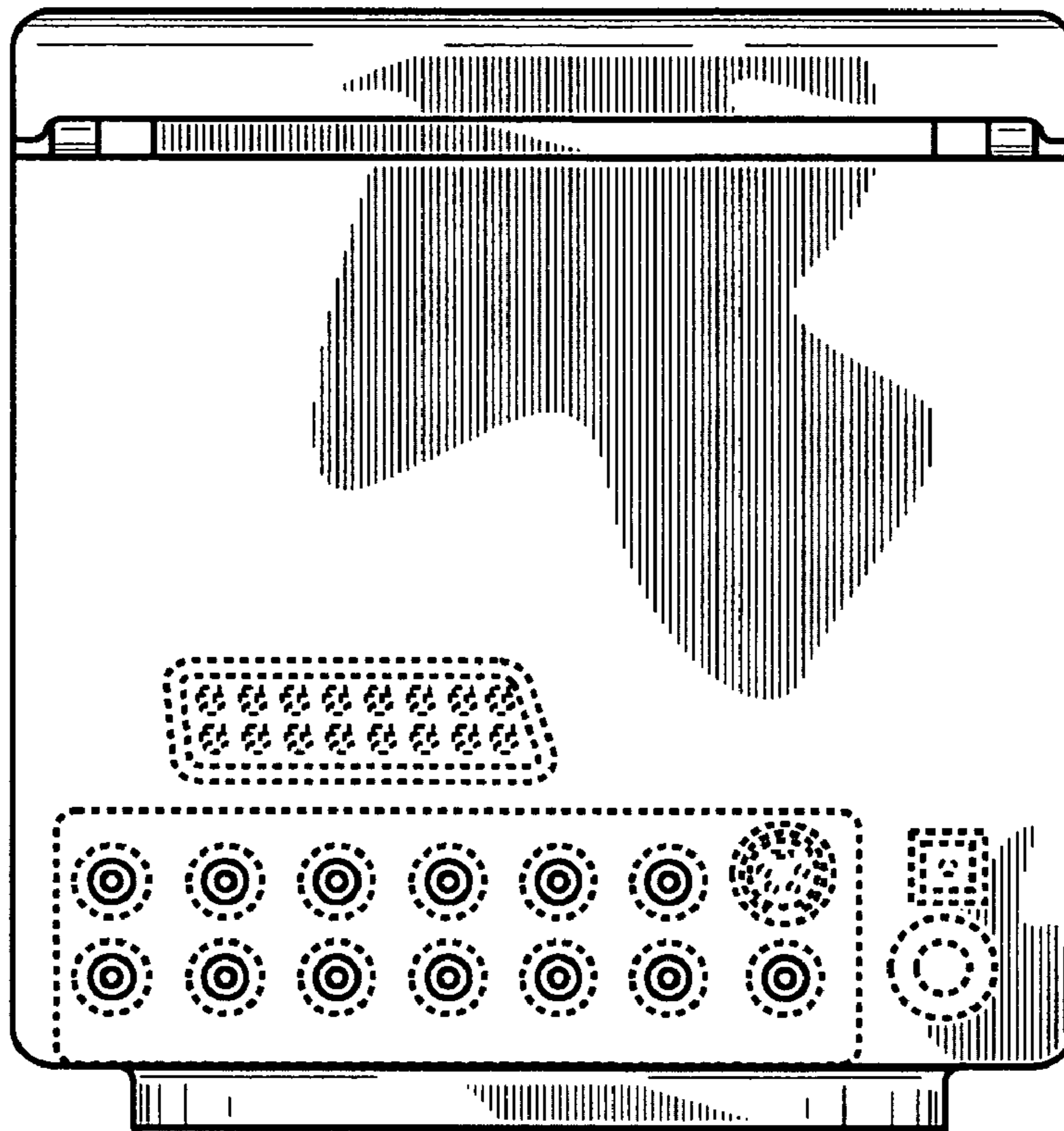

FIG. 11



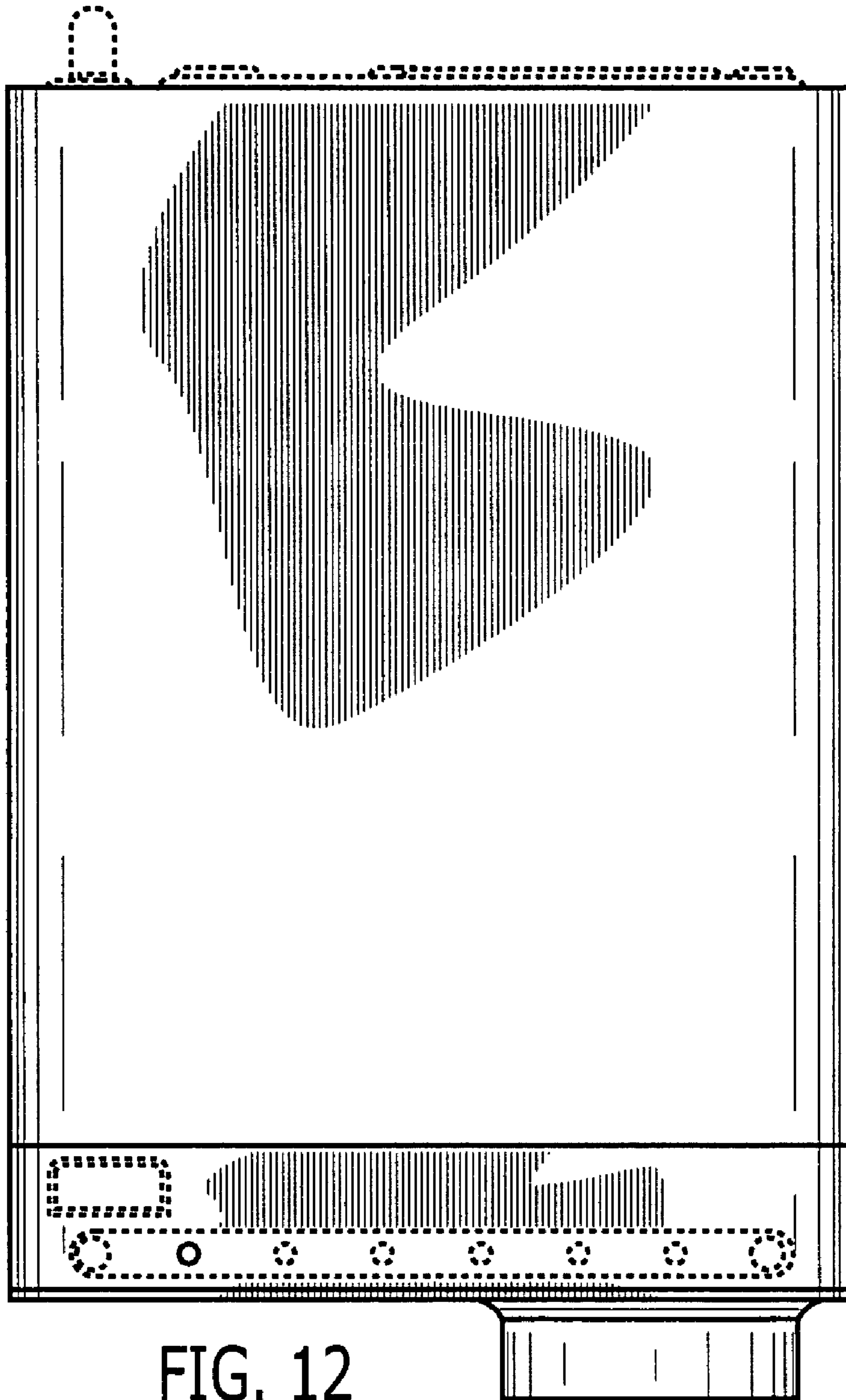

FIG. 12

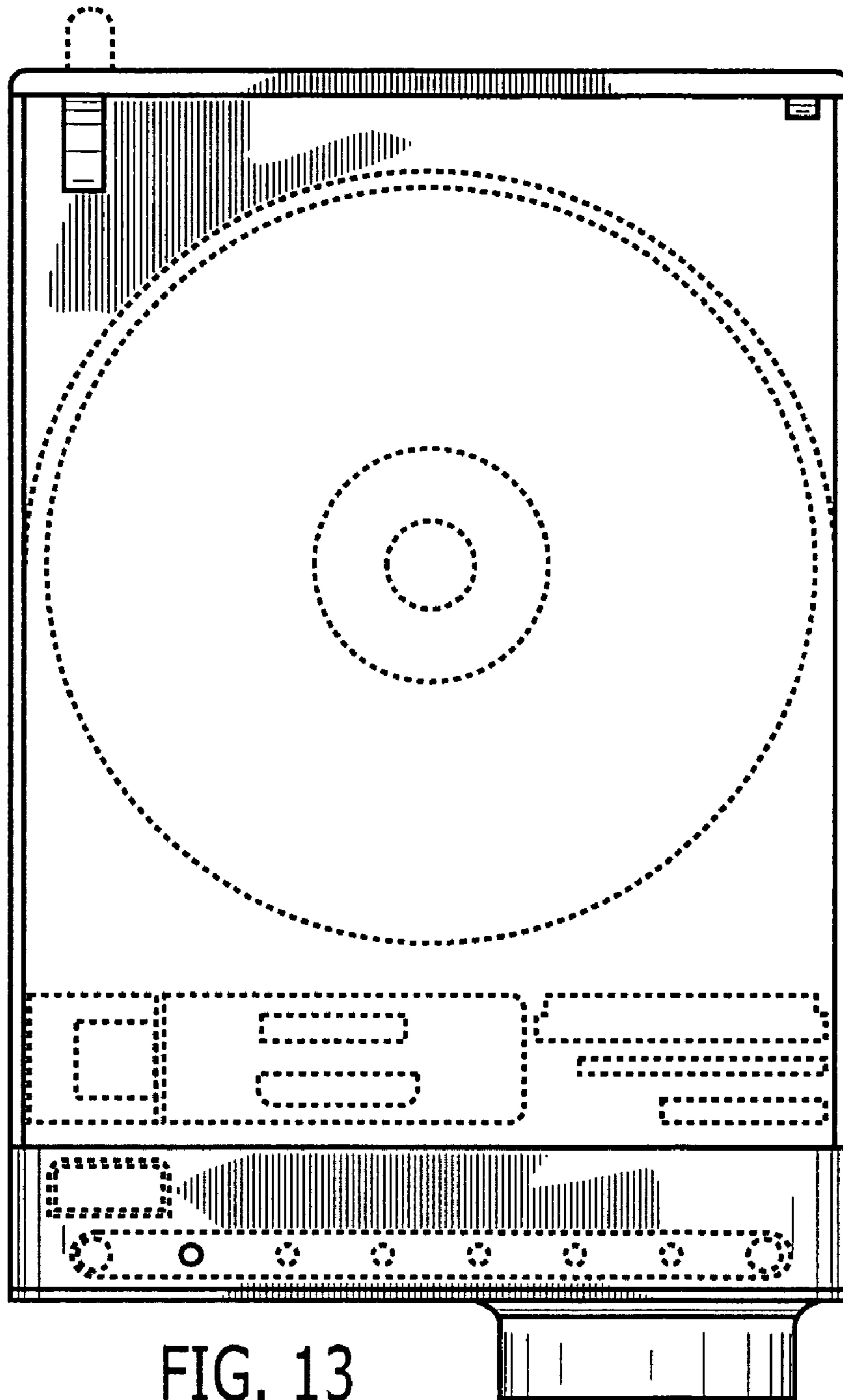

FIG. 13

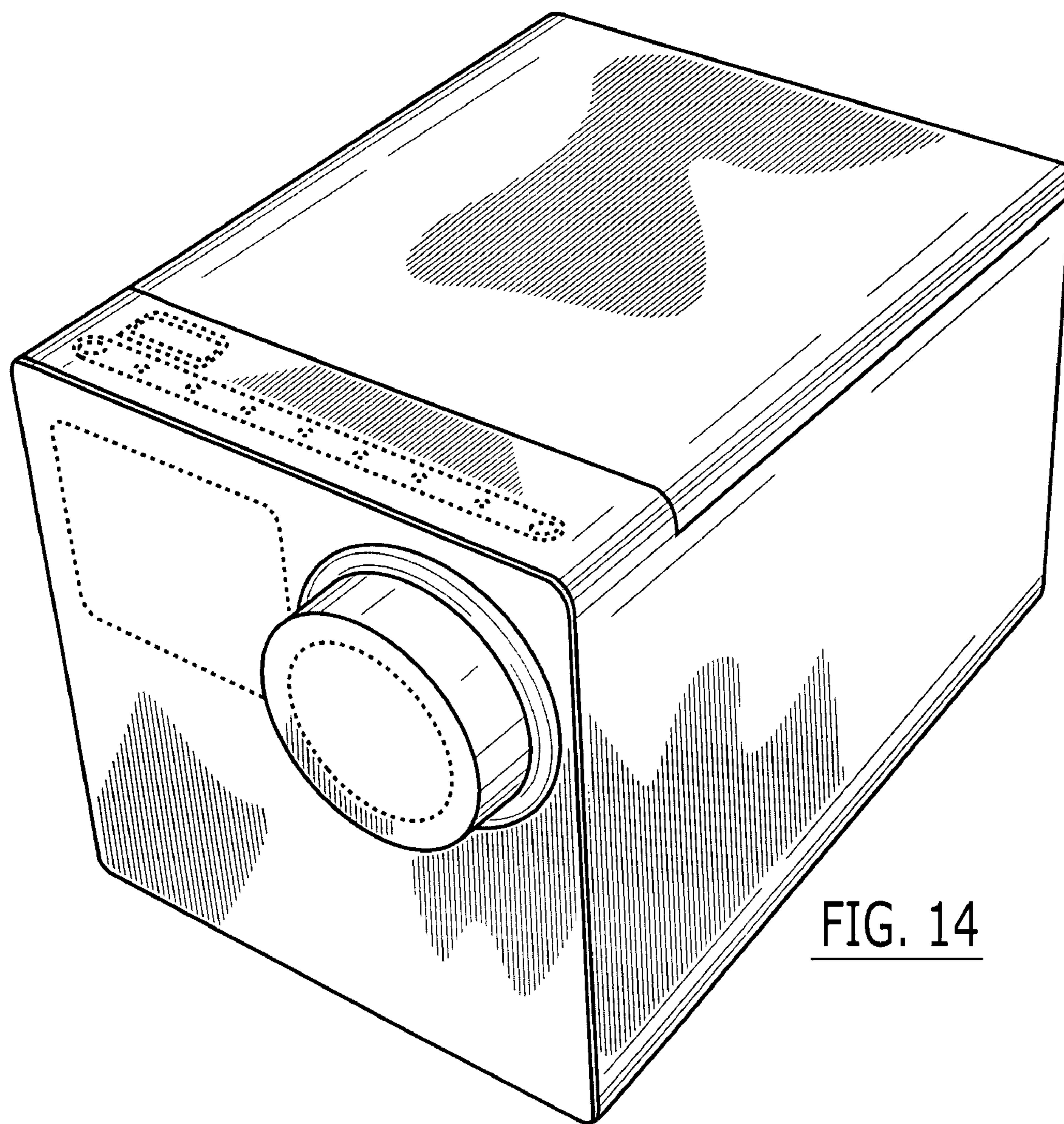

FIG. 14