



US00D556063S

(12) **United States Design Patent**  
**Chue**

(10) **Patent No.:** **US D556,063 S**

(45) **Date of Patent:** **\*\* Nov. 27, 2007**

(54) **ROUND SHAPE BMI MEASURING TAPE**

4,972,600 A \* 11/1990 Nosek ..... 33/761  
D426,477 S \* 6/2000 Jones ..... D10/72  
D435,226 S \* 12/2000 Bayer et al. .... D10/72

(75) Inventor: **Lap Fu Chue**, New Territories (HK)

(73) Assignee: **Kenki (H.K.) Ltd.**, Kowloon (HK)

\* cited by examiner

(\*\*) Term: **14 Years**

*Primary Examiner*—Antoine D. Davis  
(74) *Attorney, Agent, or Firm*—Rabin & Berdo, P.C.

(21) Appl. No.: **29/258,666**

(57) **CLAIM**

(22) Filed: **Apr. 26, 2006**

The ornamental design for a round shape BMI measuring tape, as shown and described.

(51) **LOC (8) Cl.** ..... **10-04**

(52) **U.S. Cl.** ..... **D10/72**

(58) **Field of Classification Search** ..... D10/72;  
33/755-771; 242/292, 381.1, 381.2, 381.3,  
242/381.4, 381.5, 381.6

**DESCRIPTION**

See application file for complete search history.

FIG. 1 is a front view of a round shape BMI measuring tape showing my new design;

FIG. 2 is a rear view thereof;

FIG. 3 is a left side view thereof;

FIG. 4 is a right side view thereof;

FIG. 5 is a top view thereof;

FIG. 6 is a bottom view thereof; and,

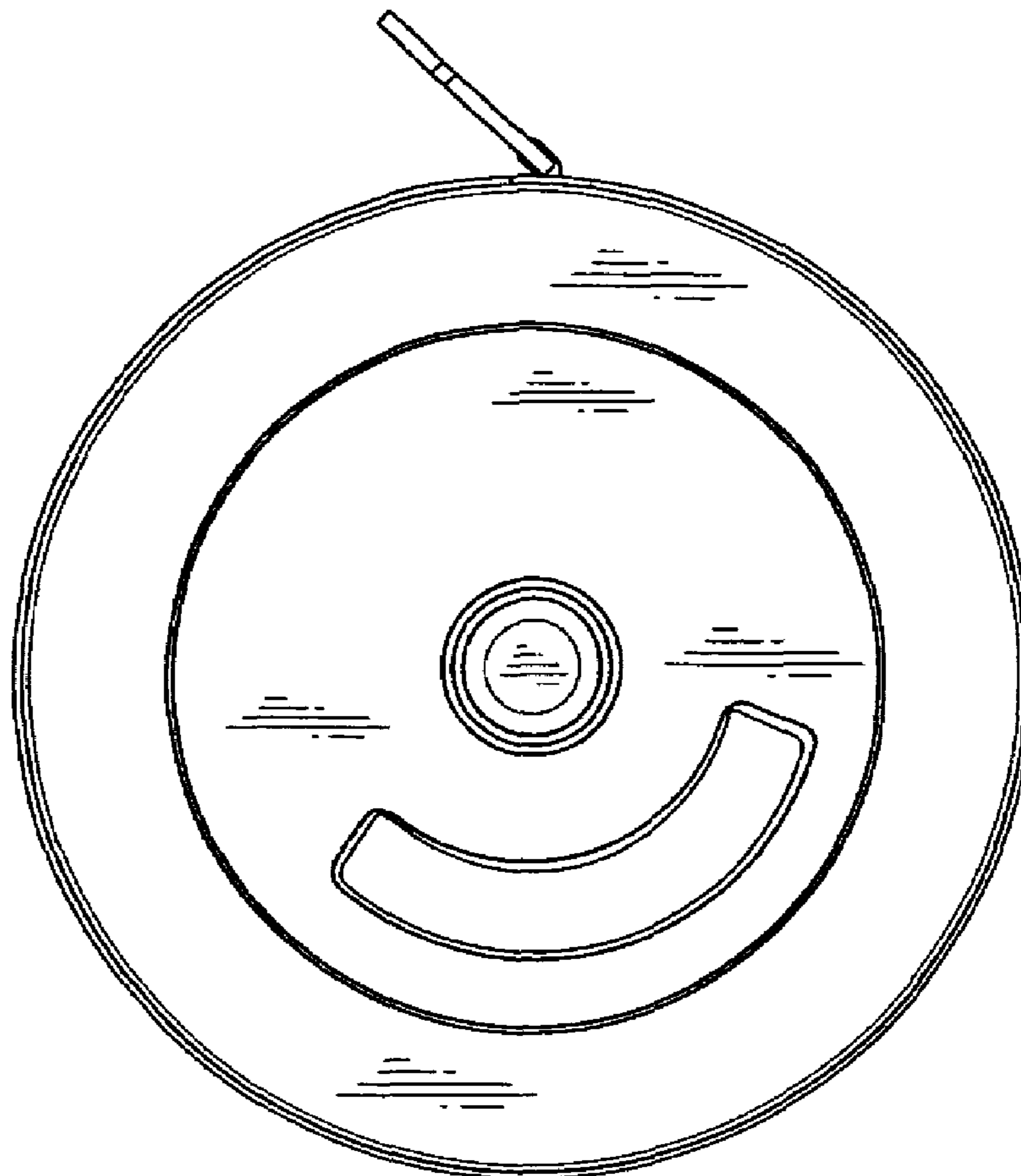
FIG. 7 is a perspective view thereof.

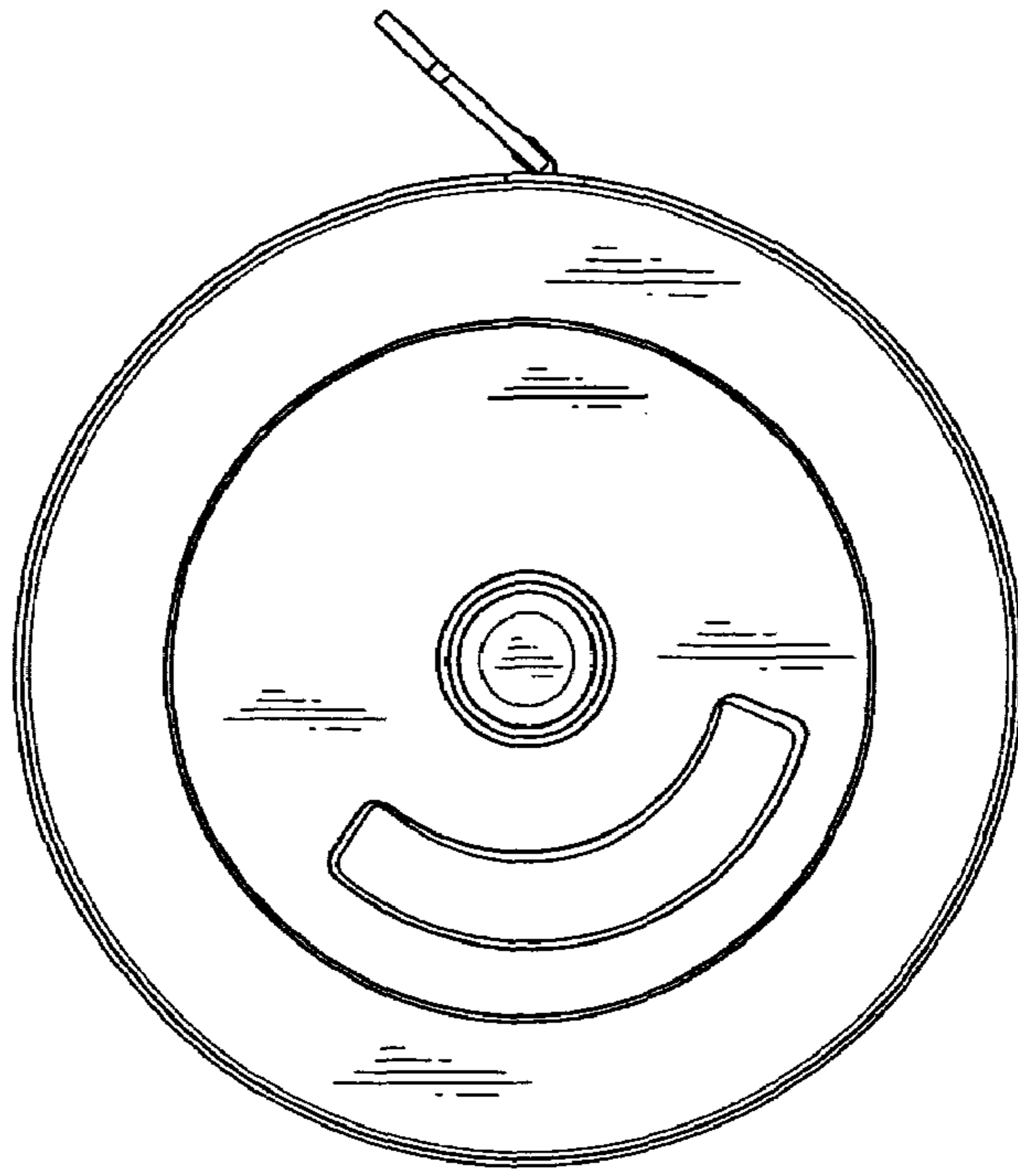
(56) **References Cited**

**U.S. PATENT DOCUMENTS**

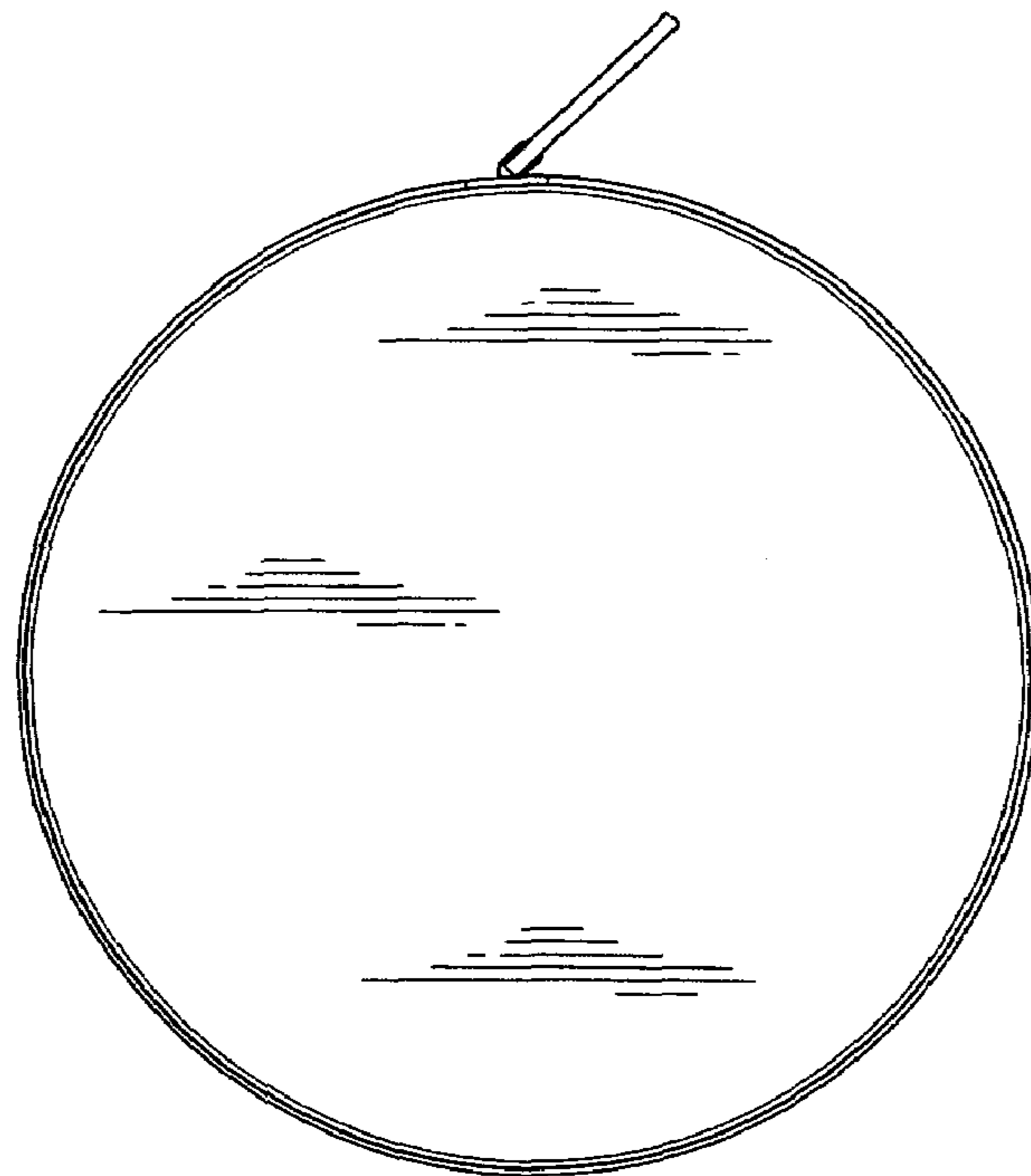
690,897 A \* 1/1902 Sims ..... 242/381.1  
D72,049 S \* 2/1927 Witchger ..... D10/72  
1,646,826 A \* 10/1927 Langsner ..... 33/758  
3,869,096 A \* 3/1975 Hogan et al. .... 242/397.5  
4,443,944 A \* 4/1984 Beesley ..... 33/761  
D304,425 S \* 11/1989 Hara et al. .... D10/72

**1 Claim, 4 Drawing Sheets**

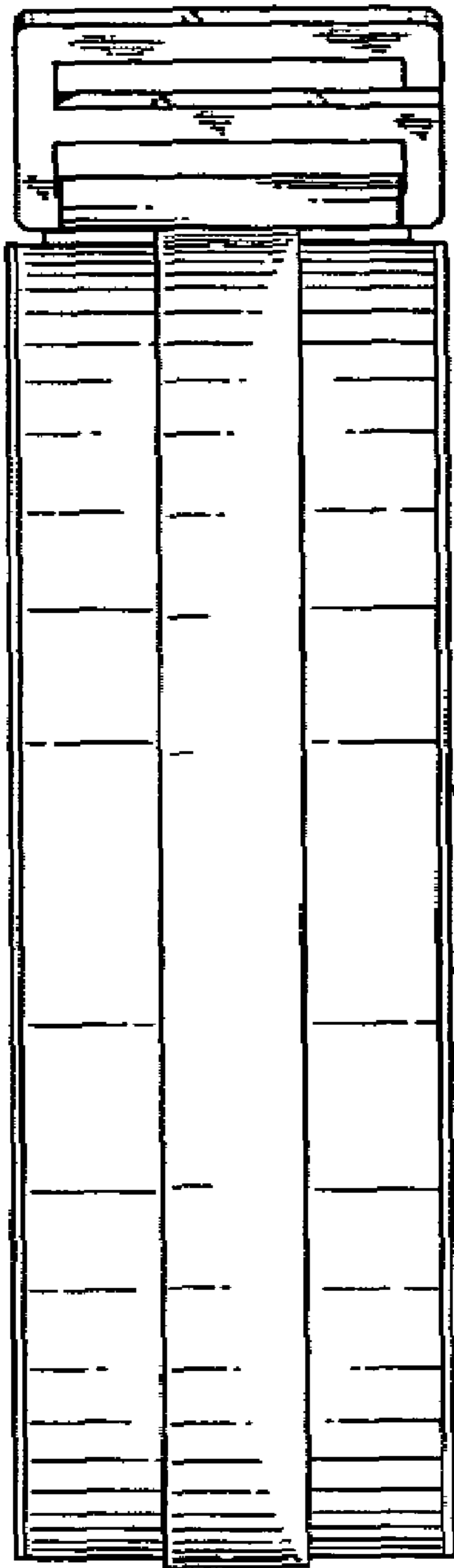




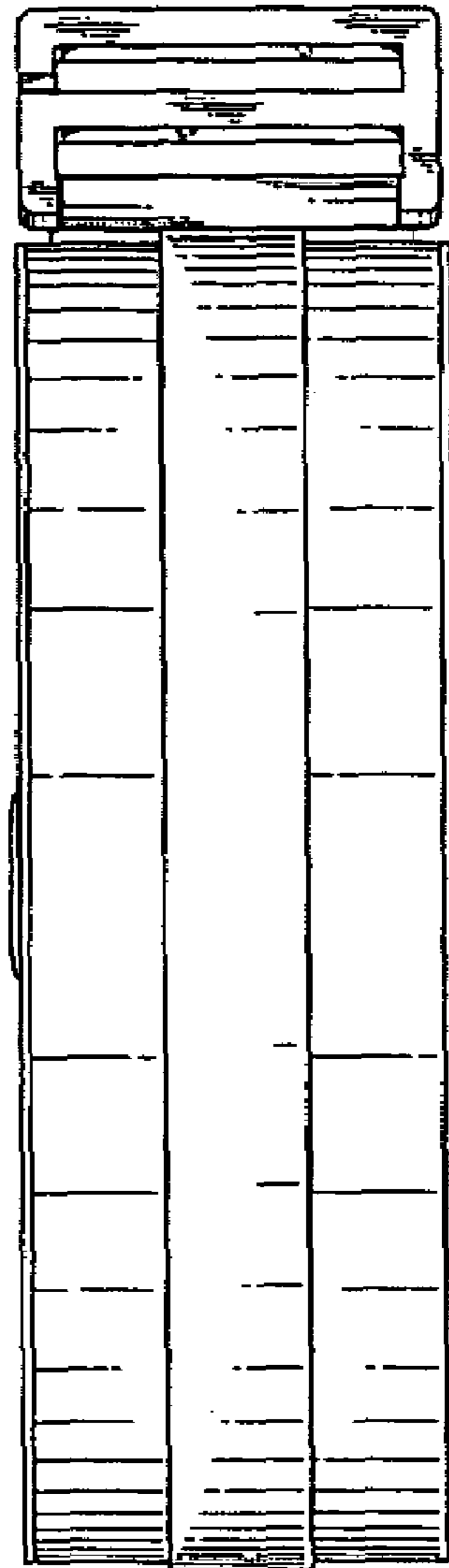
**Fig. 1**



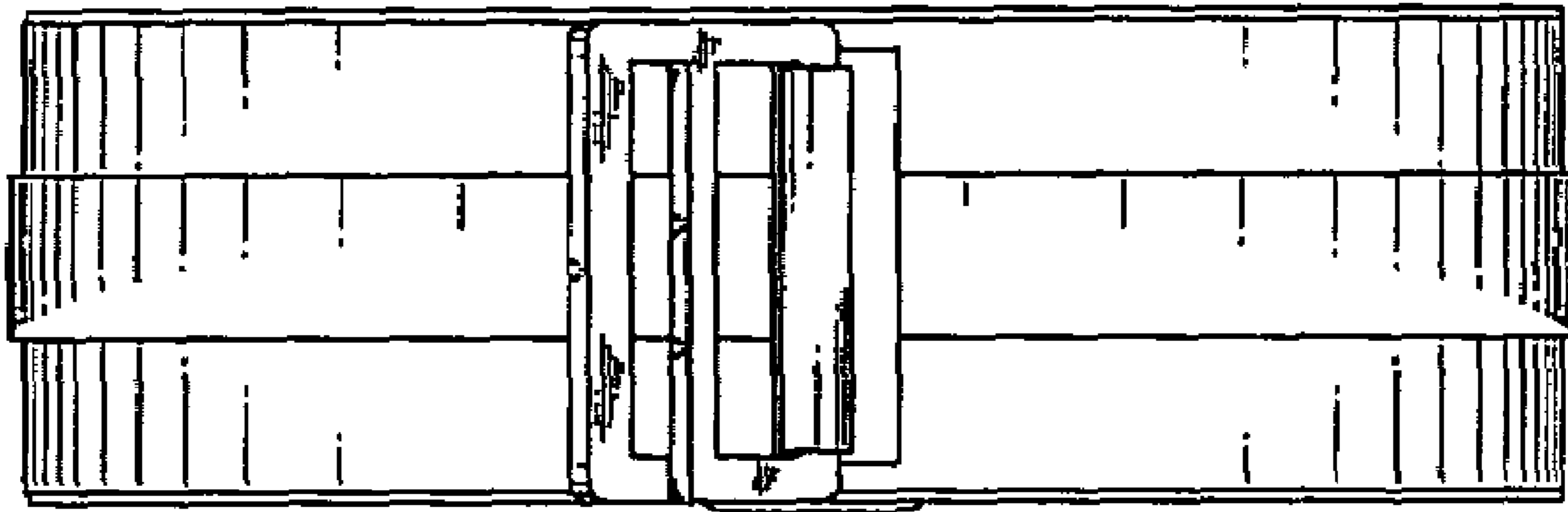
**Fig. 2**



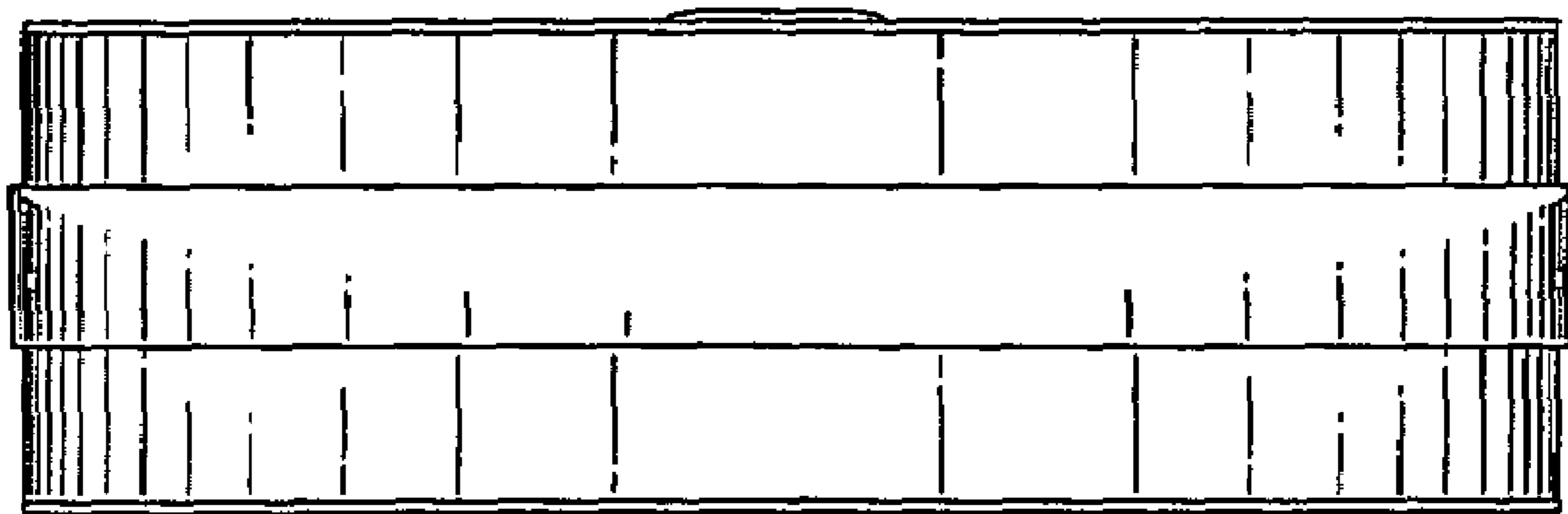
*Fig. 3*



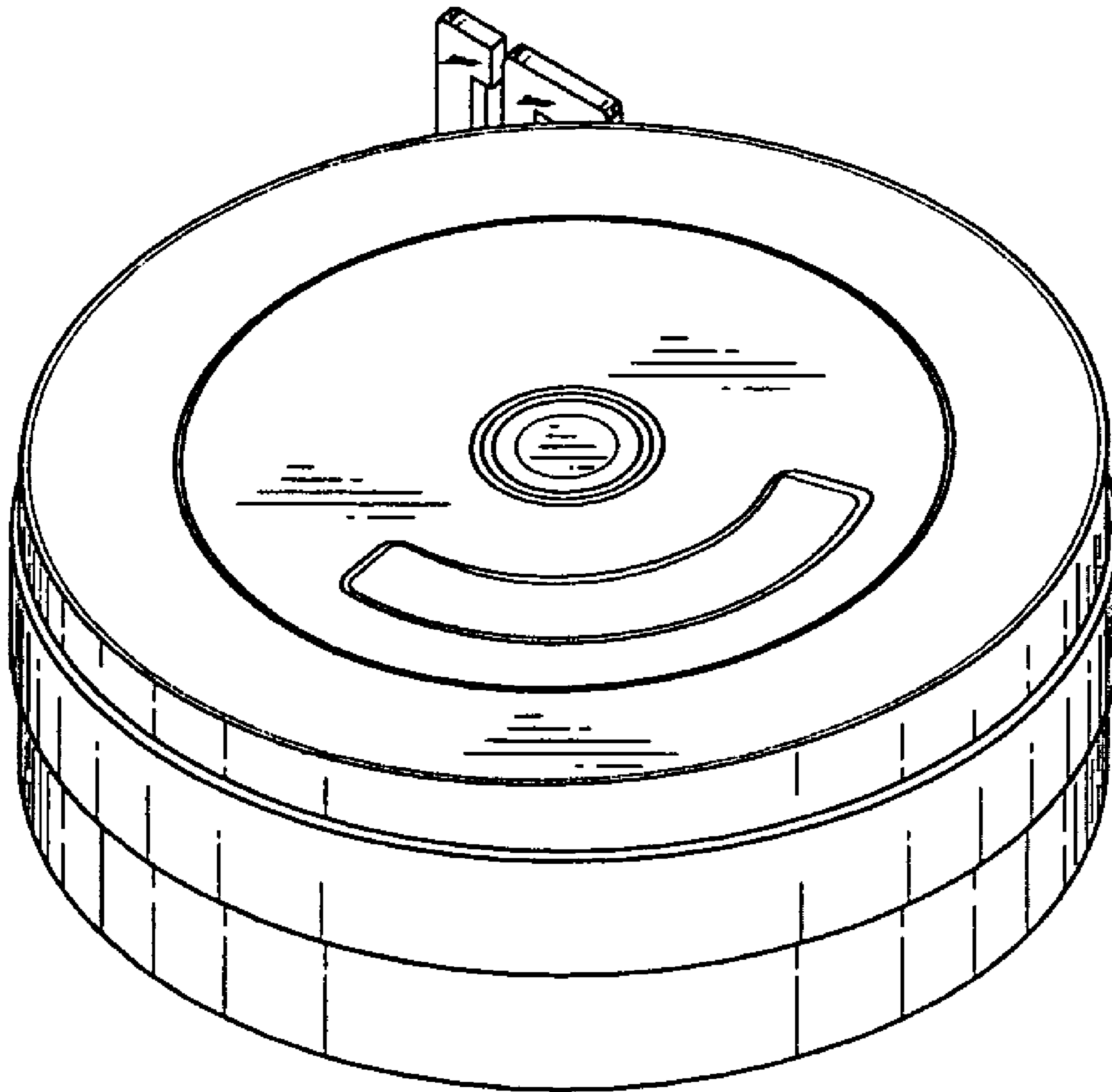
*Fig. 4*



*Fig. 5*



*Fig. 6*



*Fig. 7*