



US00D556026S

(12) **United States Design Patent**
Bennerdahl

(10) **Patent No.:** **US D556,026 S**

(45) **Date of Patent:** **** Nov. 27, 2007**

(54) **HANGER**

(75) Inventor: **Stefan Bennerdahl**, Forsheda (SE)

(73) Assignee: **Linden International AB**, Varnamo (SE)

(**) Term: **14 Years**

(21) Appl. No.: **29/209,270**

(22) Filed: **Jul. 12, 2004**

(51) **LOC (8) Cl.** **08-05**

(52) **U.S. Cl.** **D8/373**

(58) **Field of Classification Search** D8/394-395,
D8/373; 24/543; 248/488-489, 498
See application file for complete search history.

(56) **References Cited**

U.S. PATENT DOCUMENTS

D308,467 S * 6/1990 Fenton D8/373
D421,383 S * 3/2000 Walker et al. D8/373

FOREIGN PATENT DOCUMENTS

SE 517 034 C2 4/2002

* cited by examiner

Primary Examiner—Holly H. Baynham

(74) *Attorney, Agent, or Firm*—Bachman & LaPointe P.C.

(57) **CLAIM**

The ornamental design for hanger, as shown.

DESCRIPTION

FIG. 1 is a perspective view of an ornamental design of a hanger in accordance with the present invention;

FIG. 2 is a side view of the hanger of FIG. 1;

FIG. 3 is a front view of the hanger of FIG. 1;

FIG. 4 is a back view of the hanger of FIG. 1;

FIG. 5 is a top view of the hanger of FIG. 1;

FIG. 6 is a bottom view of the hanger of FIG. 1;

FIG. 7 is a perspective view of a second embodiment of the design shown in FIG. 1;

FIG. 8 is a side view thereof;

FIG. 9 is a front view thereof;

FIG. 10 is a back view thereof;

FIG. 11 is a top view thereof;

FIG. 12 is a bottom view thereof;

FIG. 13 is a perspective view of a third embodiment of the design shown in FIG. 1;

FIG. 14 is a side elevational view thereof;

FIG. 15 is a front elevational view thereof;

FIG. 16 is a rear elevational view thereof;

FIG. 17 is a top plan view thereof;

FIG. 18 is a bottom plan view thereof;

FIG. 19 is a perspective view of a fourth embodiment of the design shown in FIG. 1;

FIG. 20 is a side elevational view;

FIG. 21 is a front elevational view;

FIG. 22 is a rear elevational view;

FIG. 23 is a top plan view thereof; and,

FIG. 24 is a bottom plan view.

1 Claim, 4 Drawing Sheets

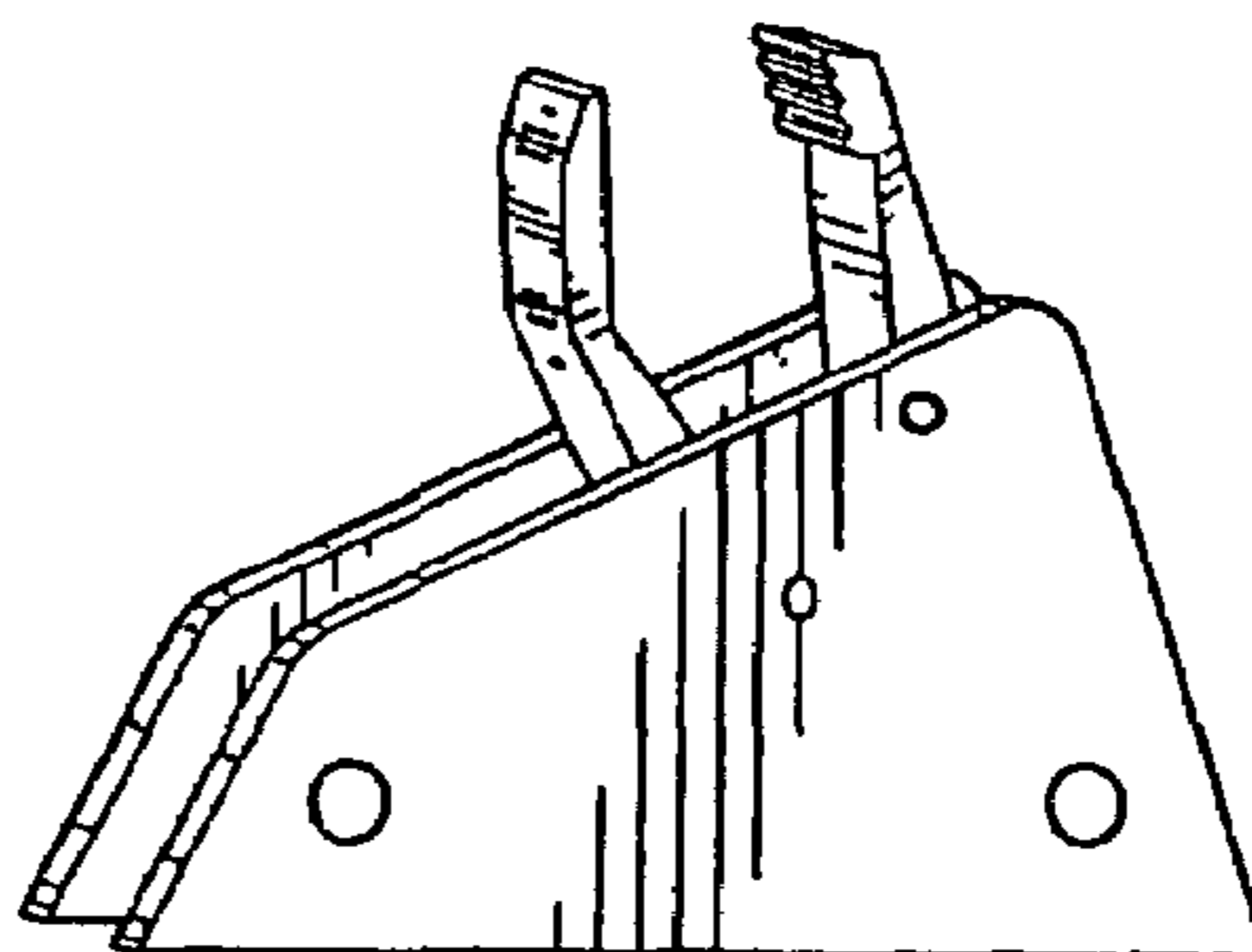
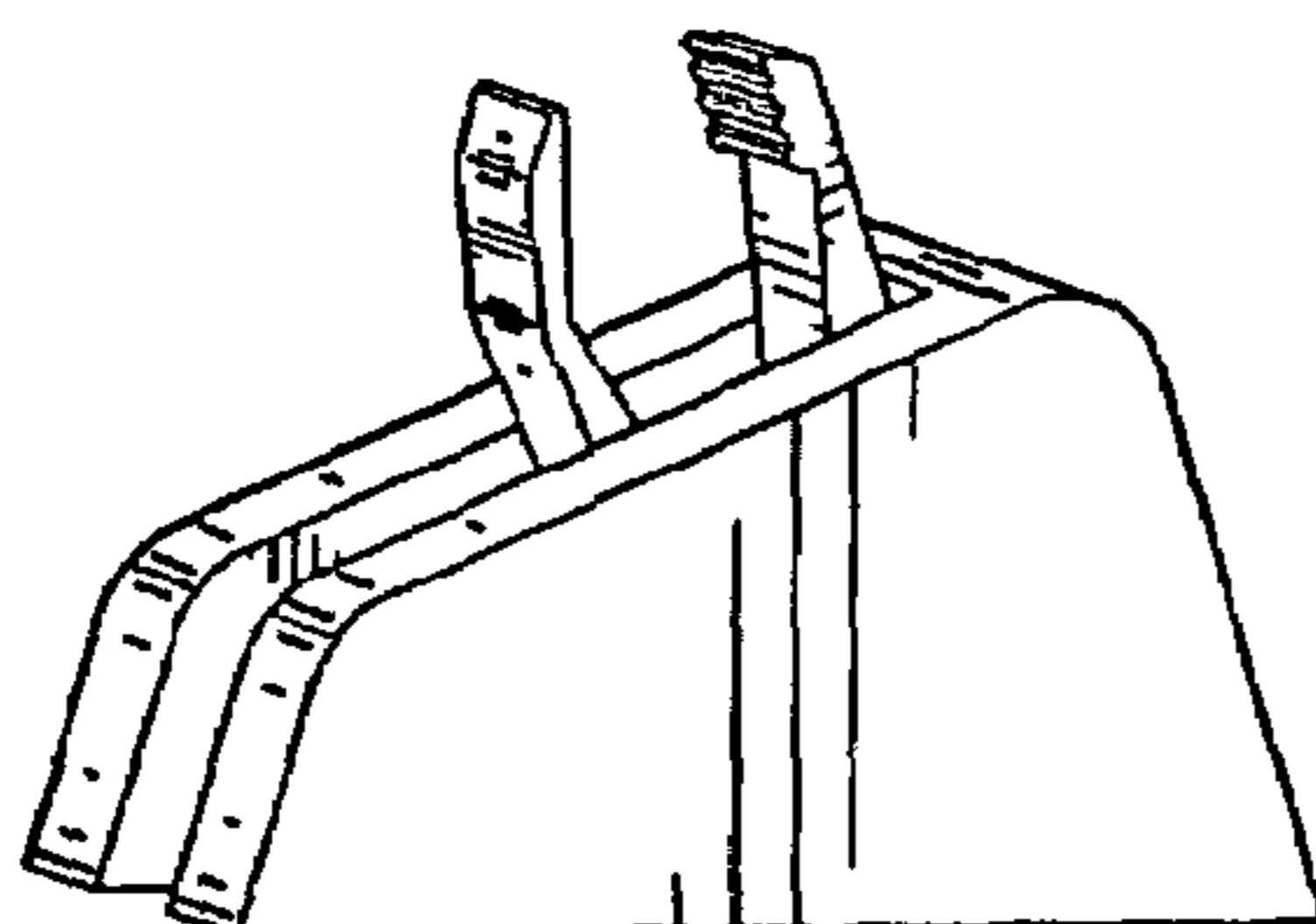
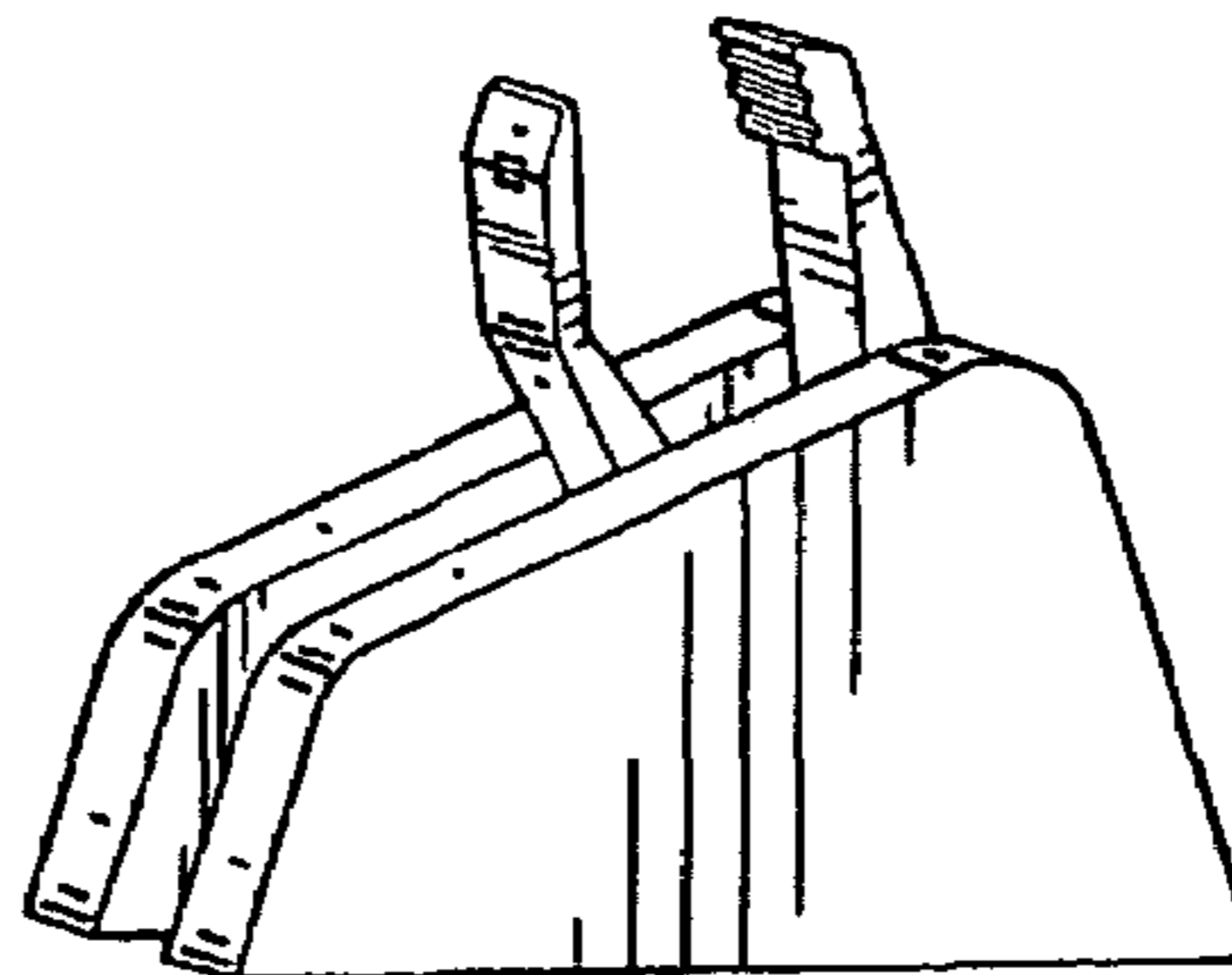
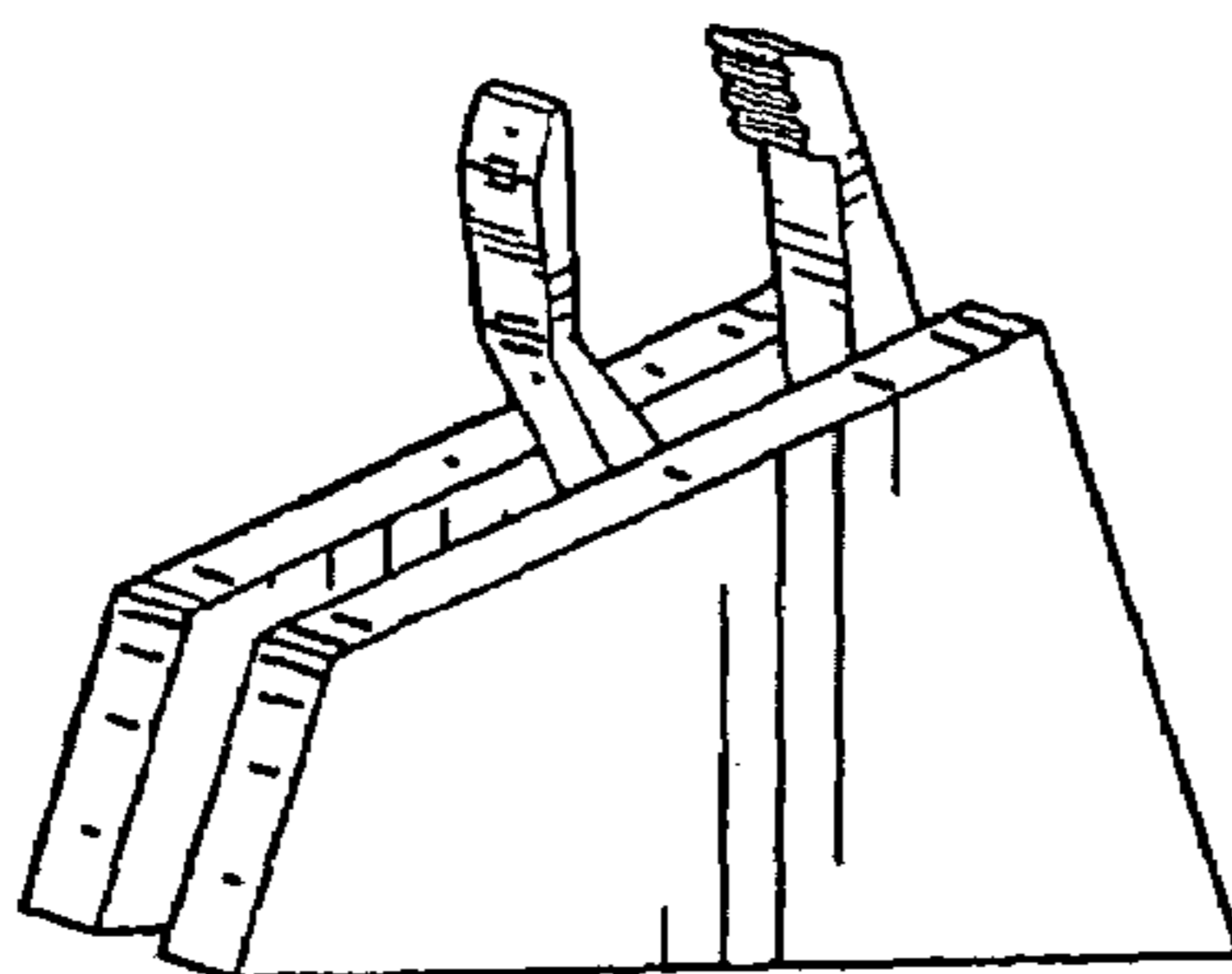

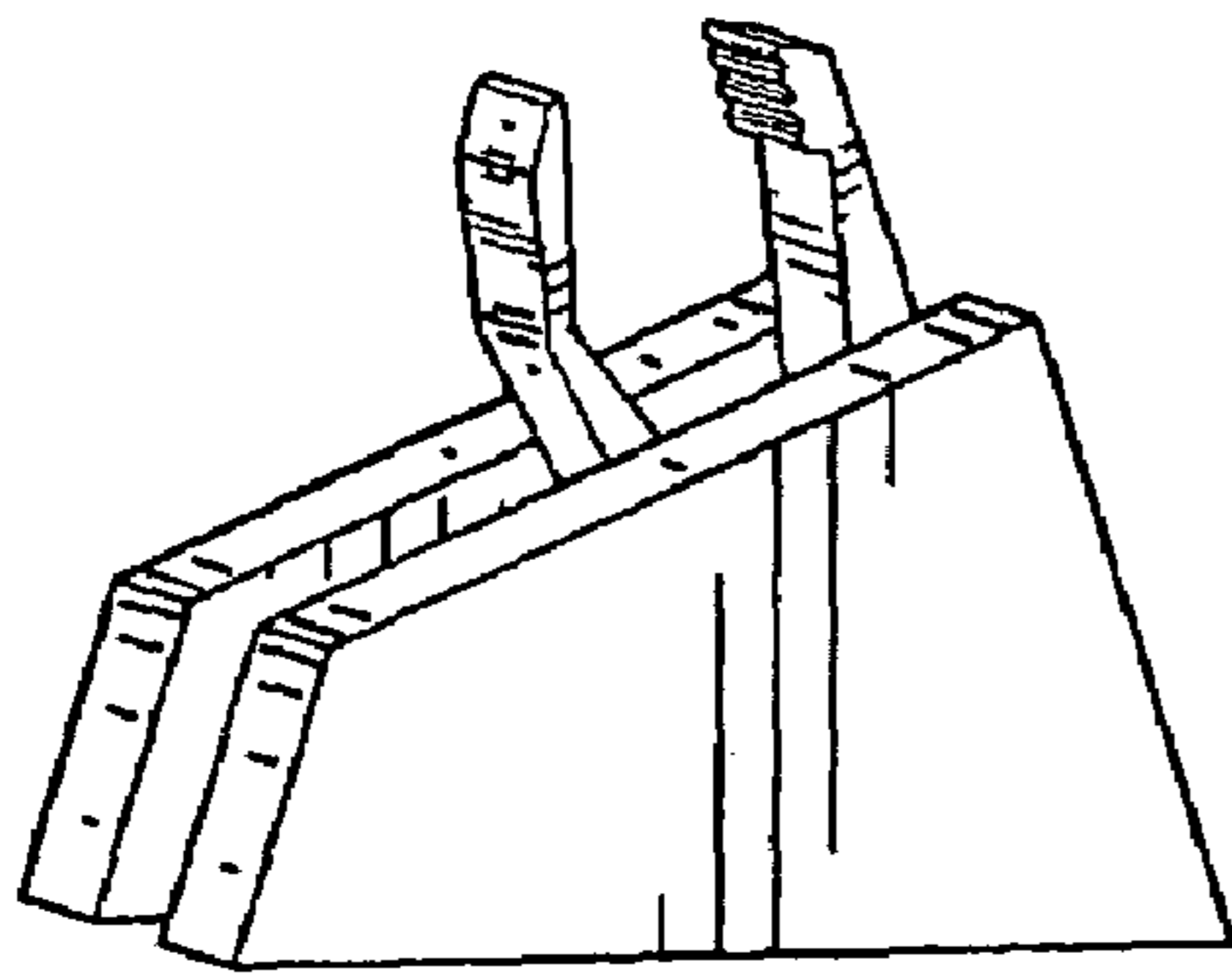

FIG. 1

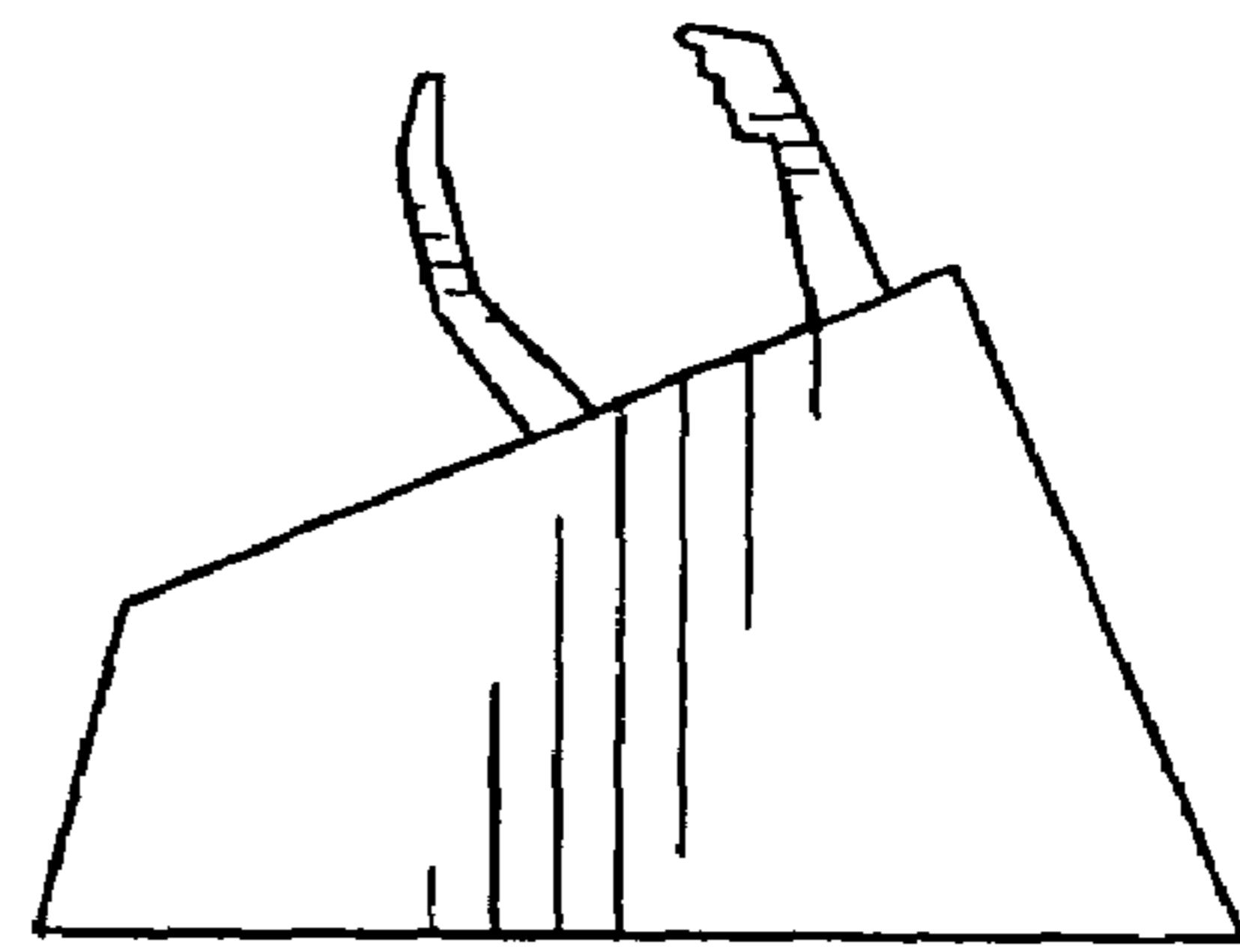

FIG. 2

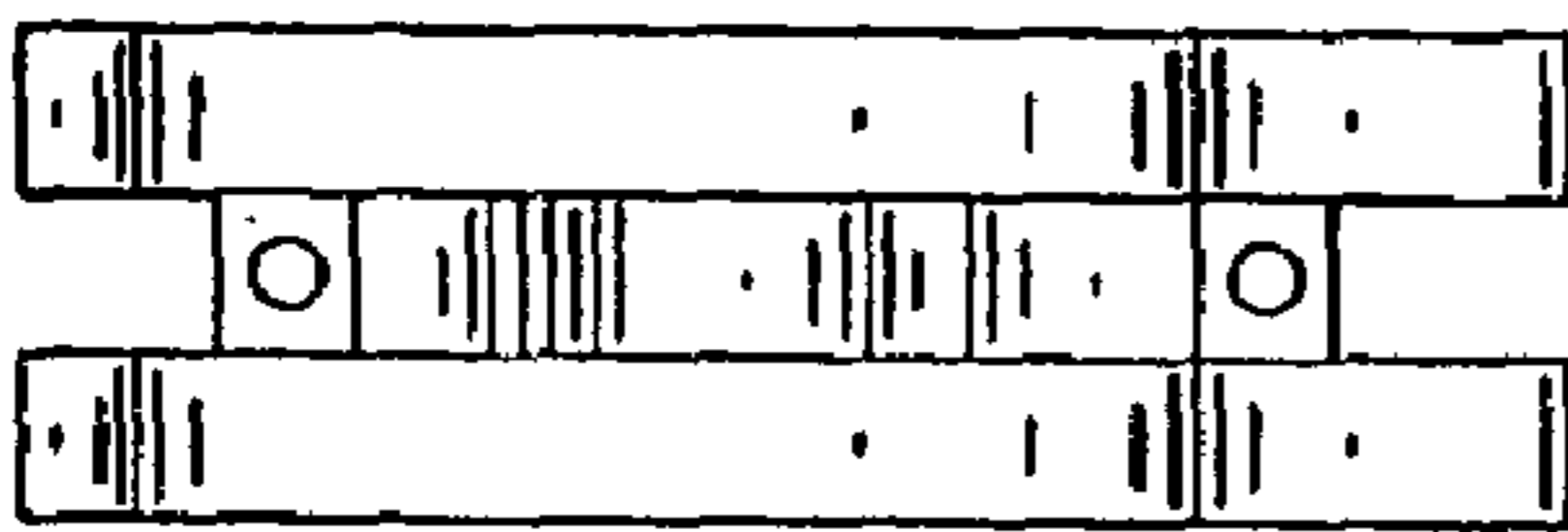

FIG. 3

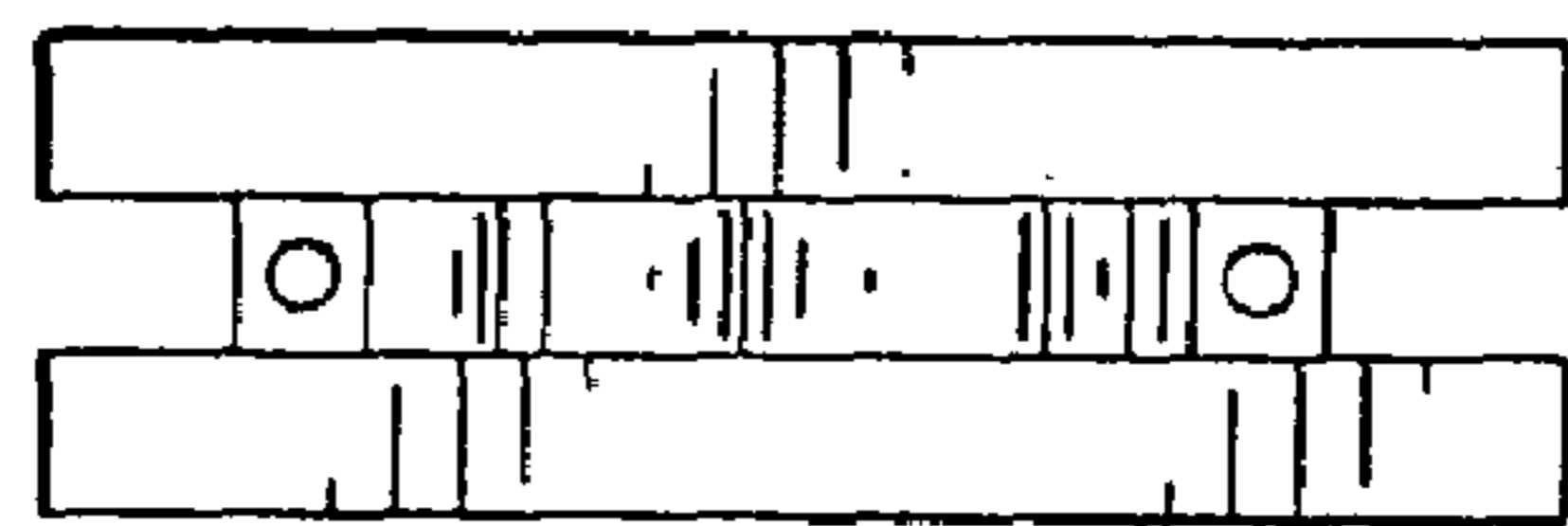

FIG. 4

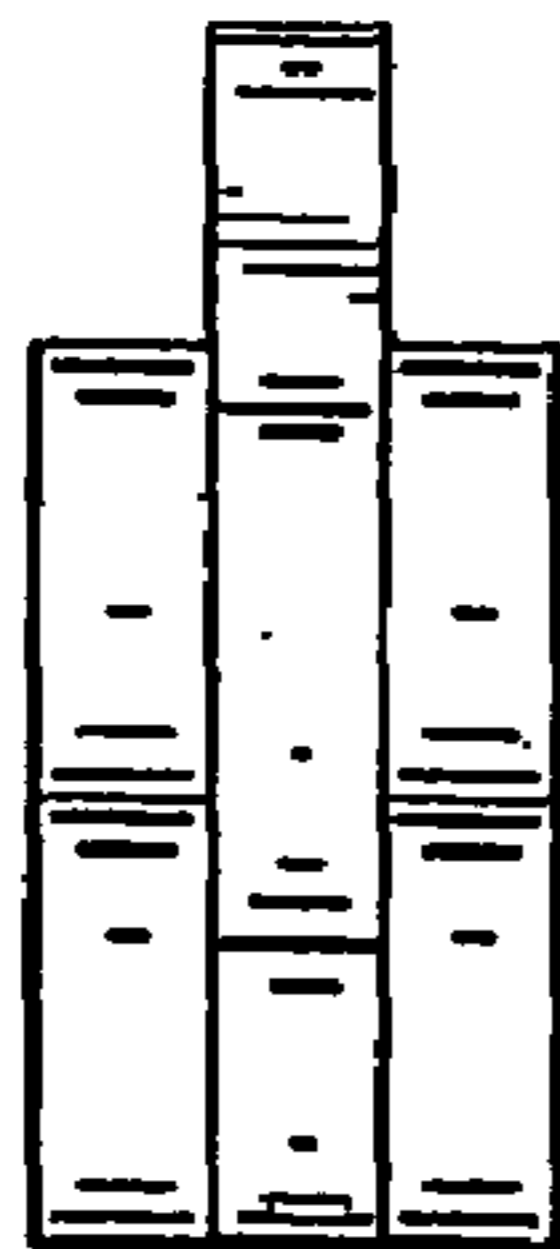

FIG. 5



FIG. 6

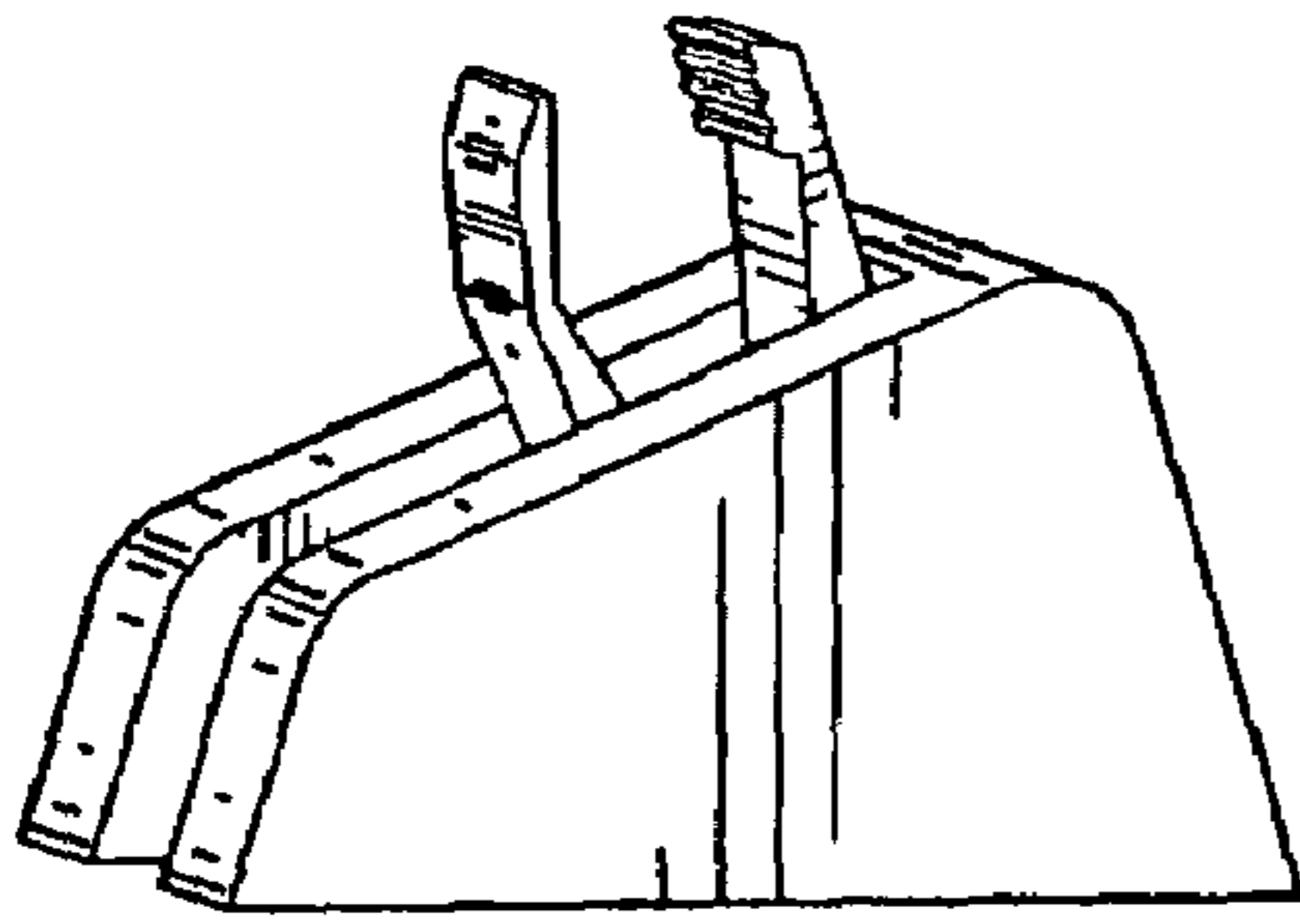

FIG. 7

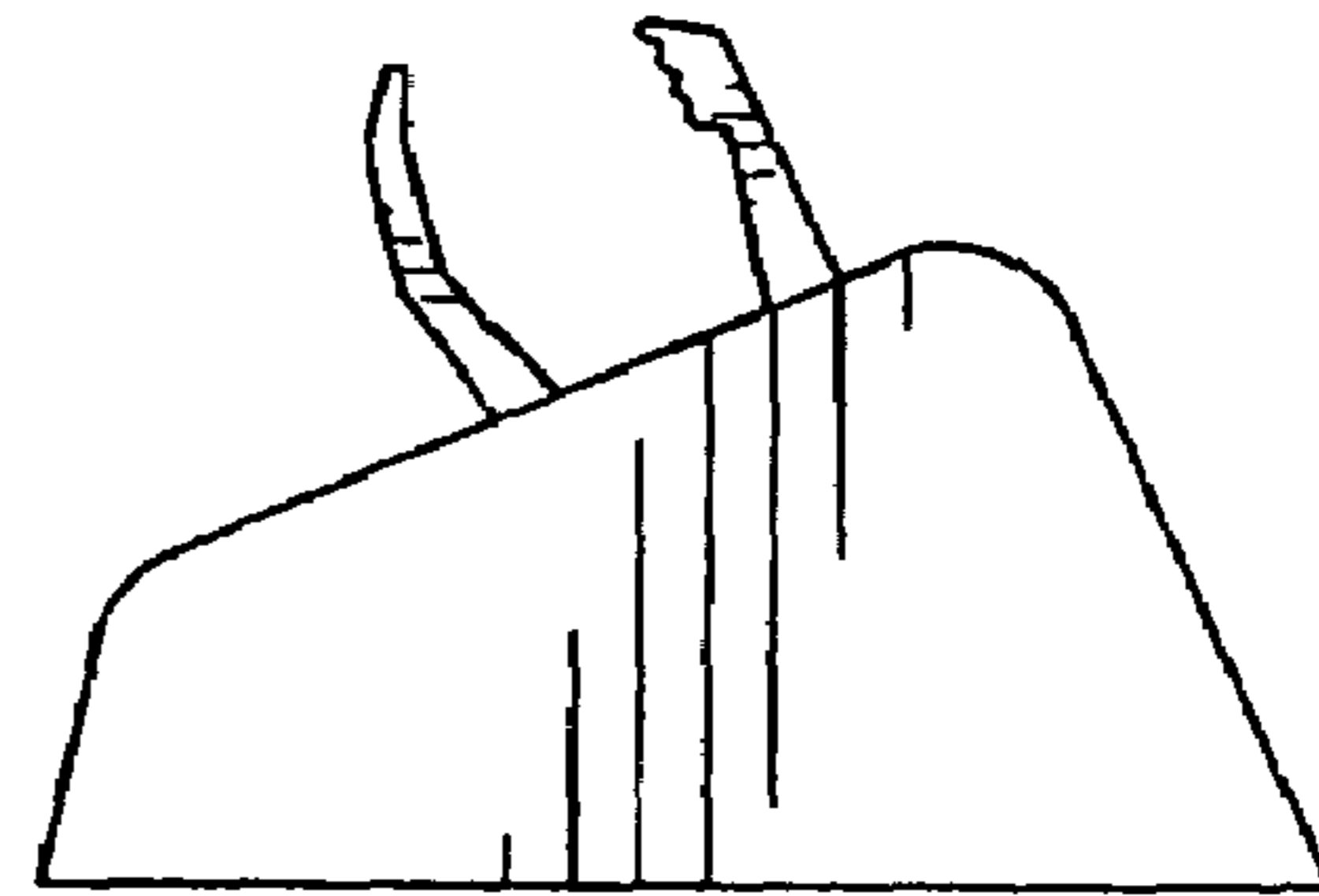

FIG. 8

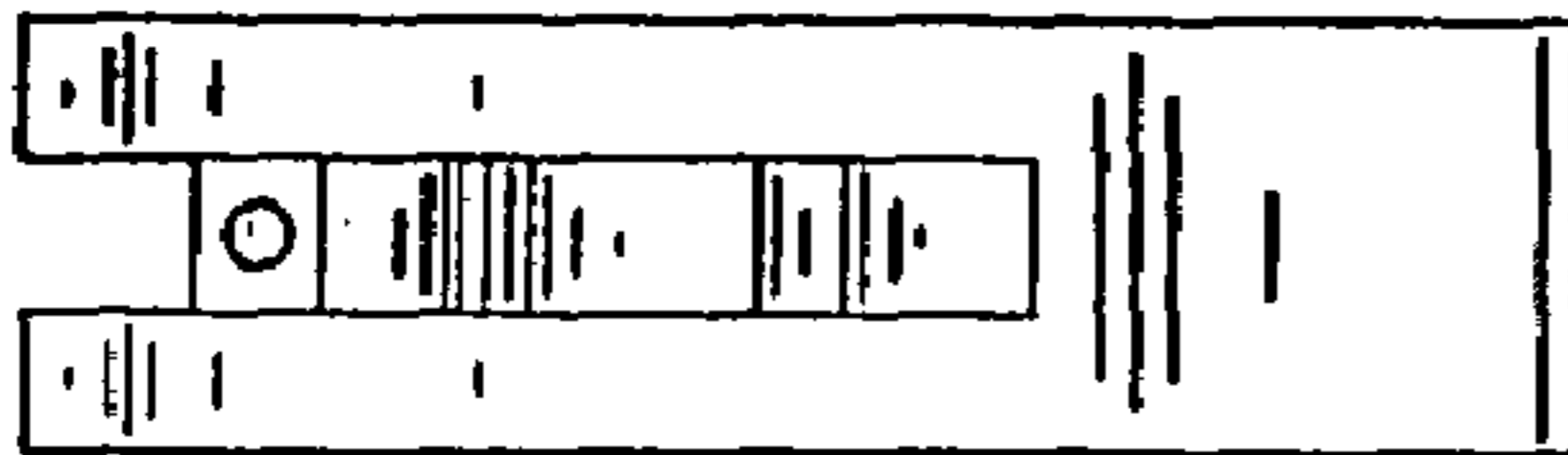

FIG. 9

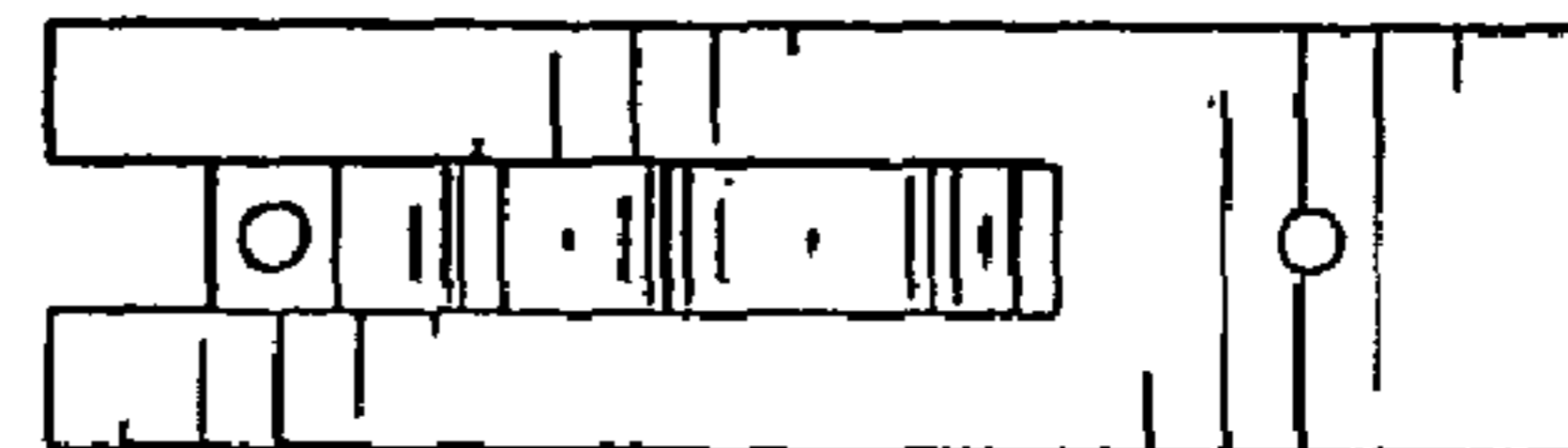

FIG. 10

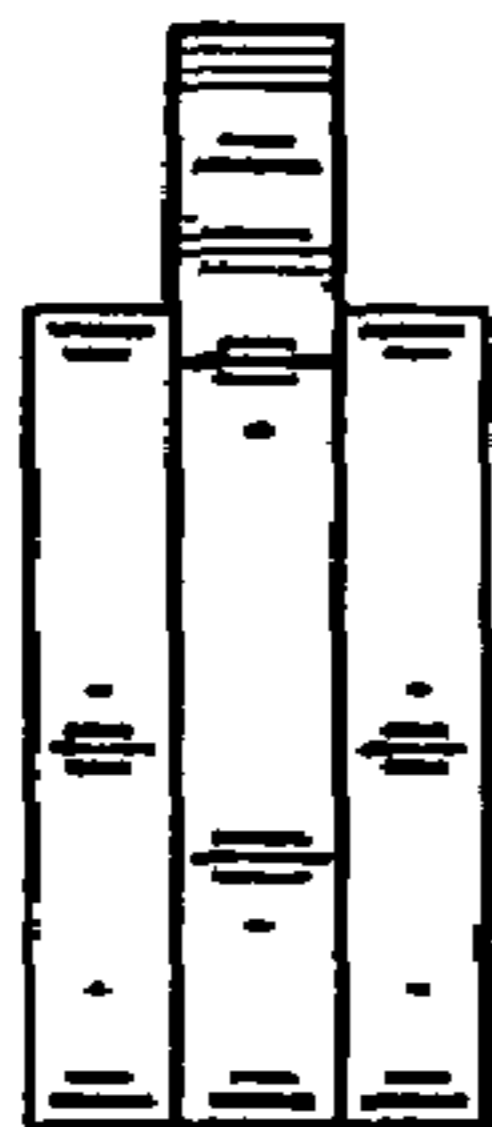

FIG. 11



FIG. 12

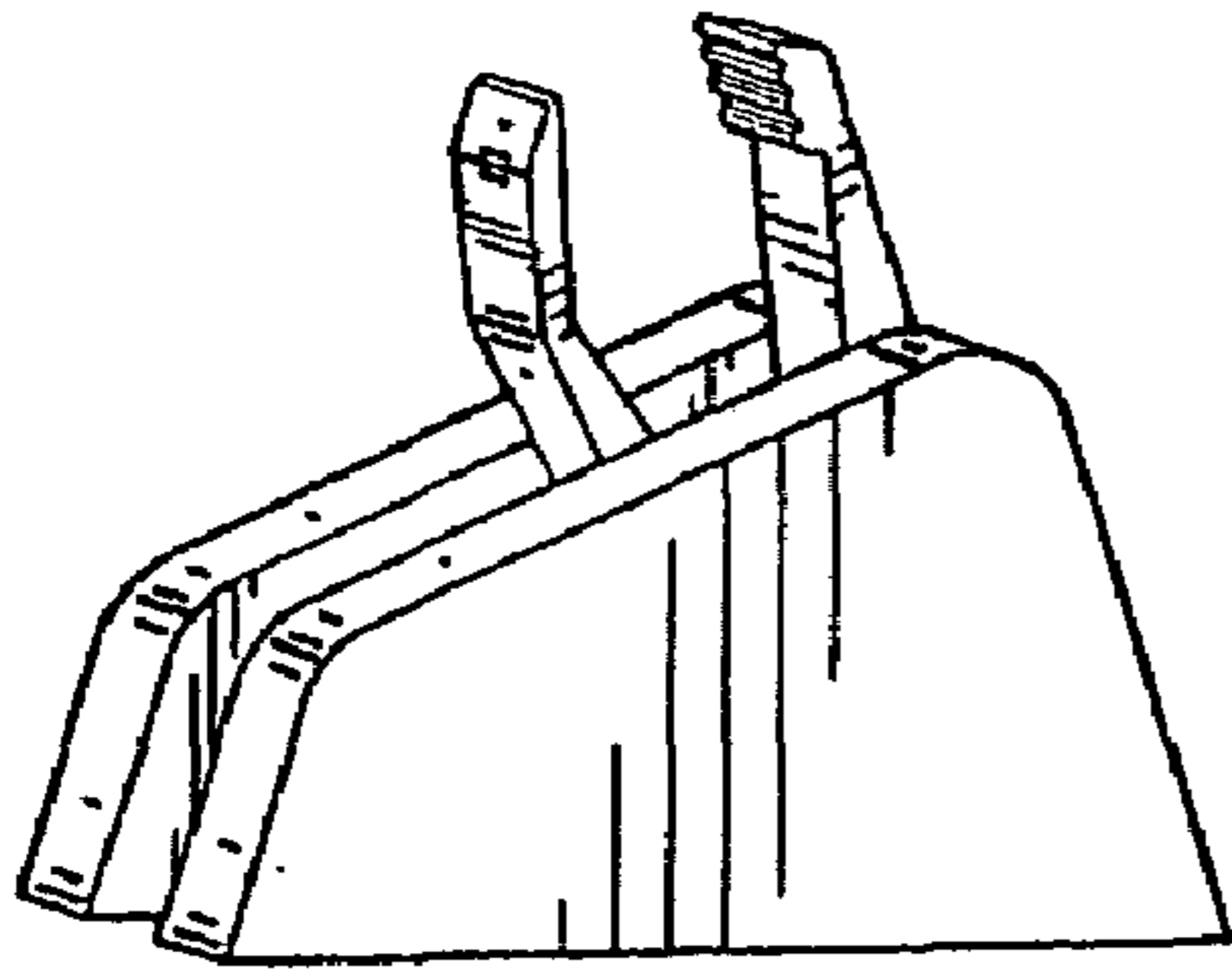

FIG. 13

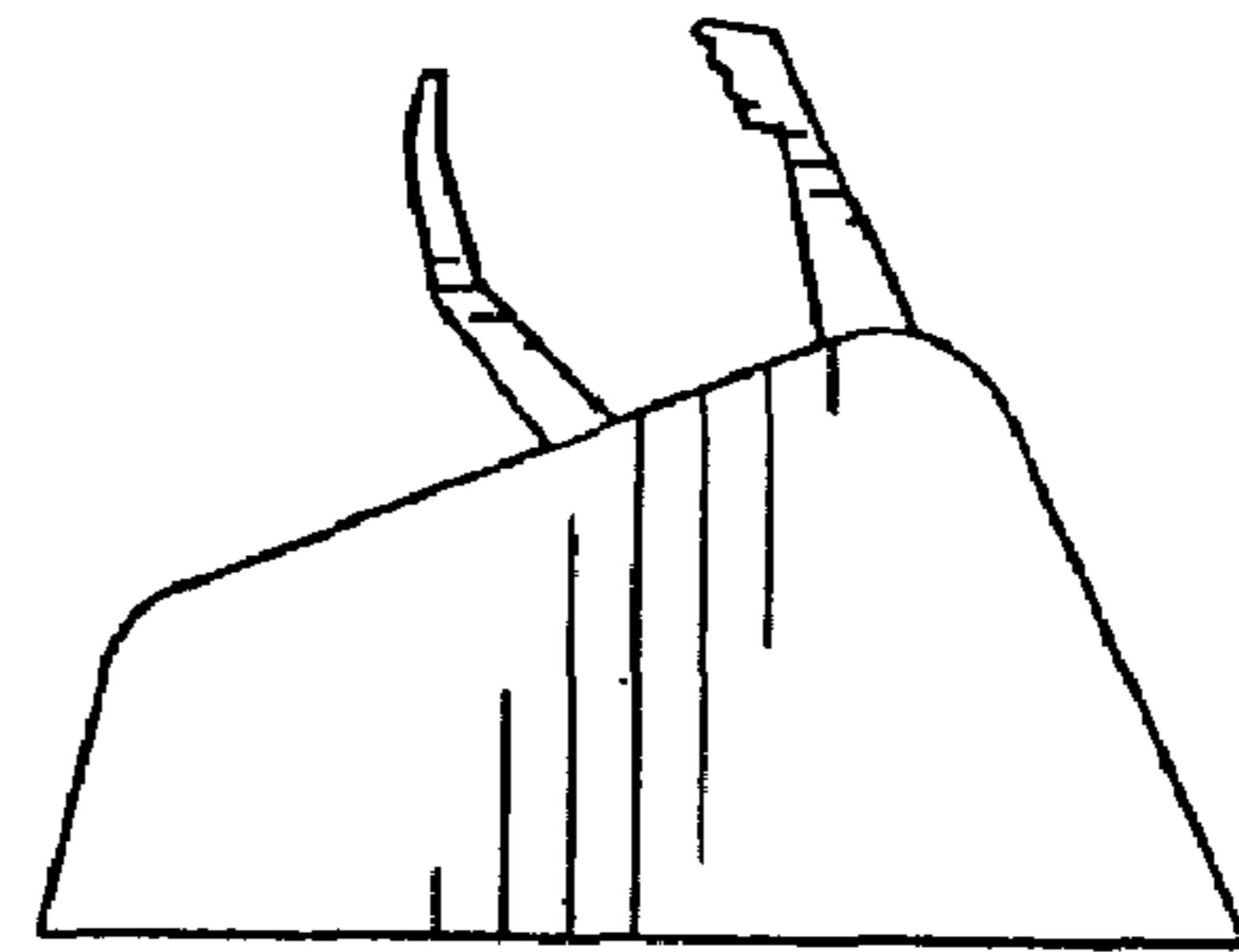

FIG. 14

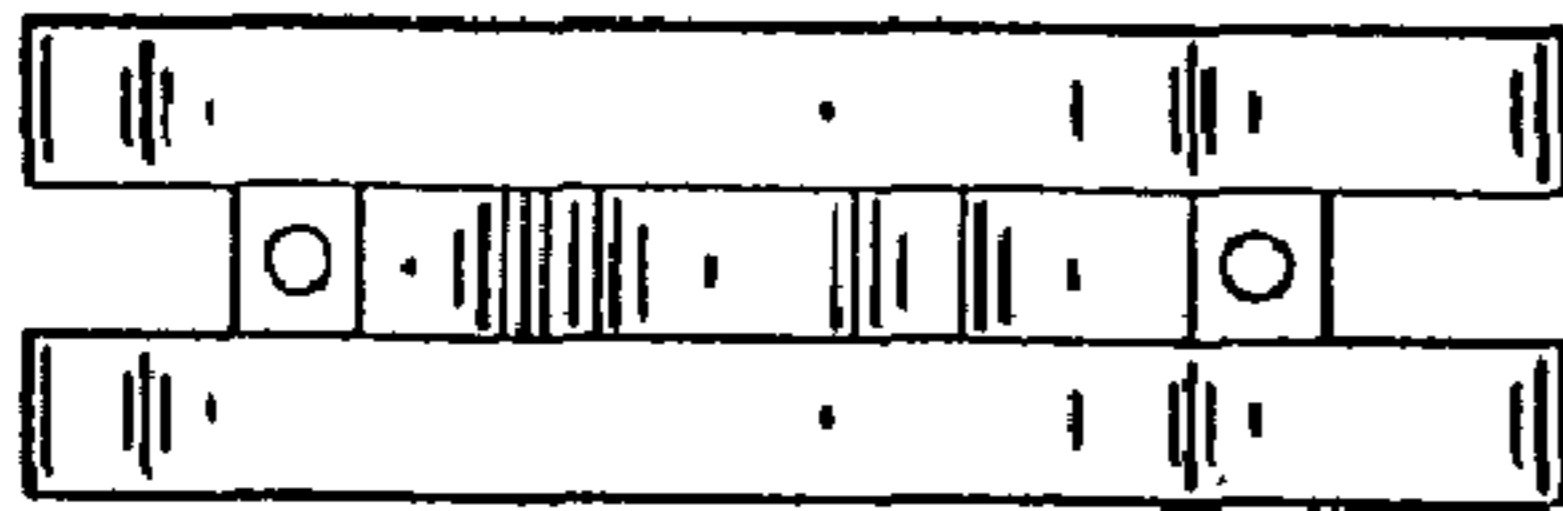

FIG. 15

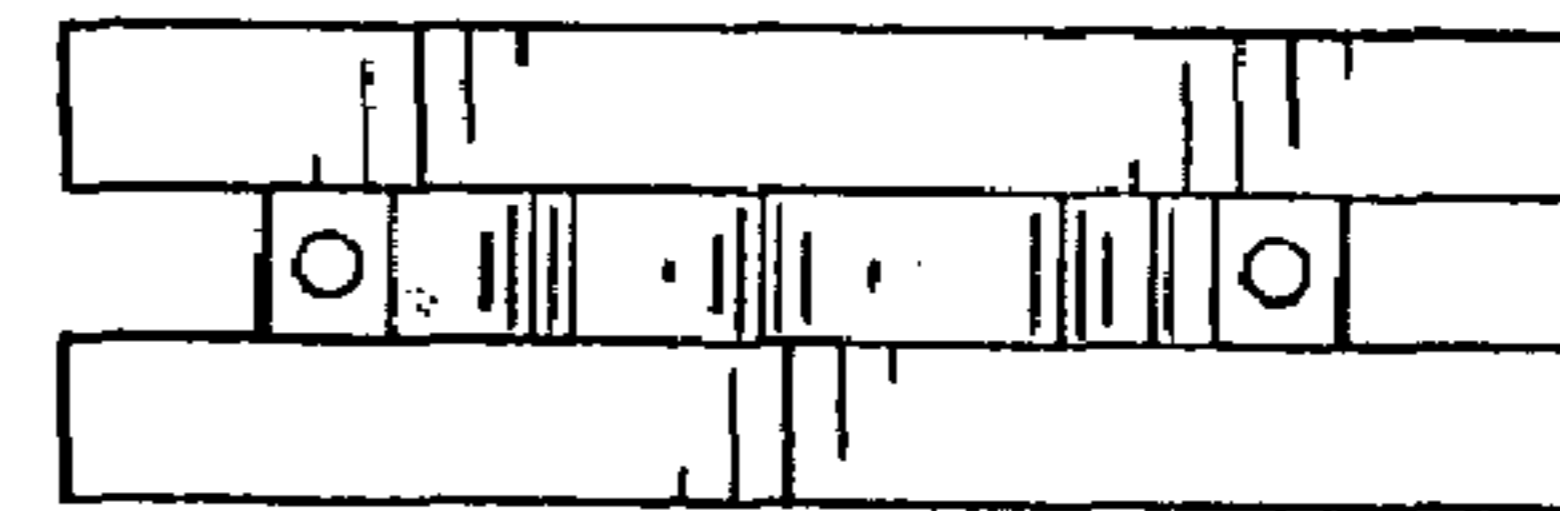

FIG. 16

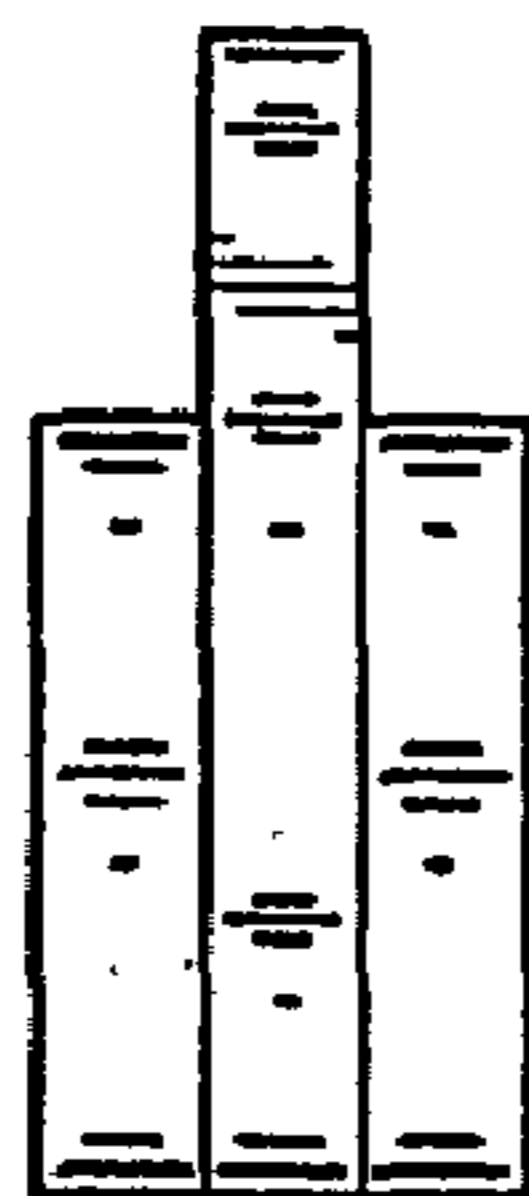

FIG. 17

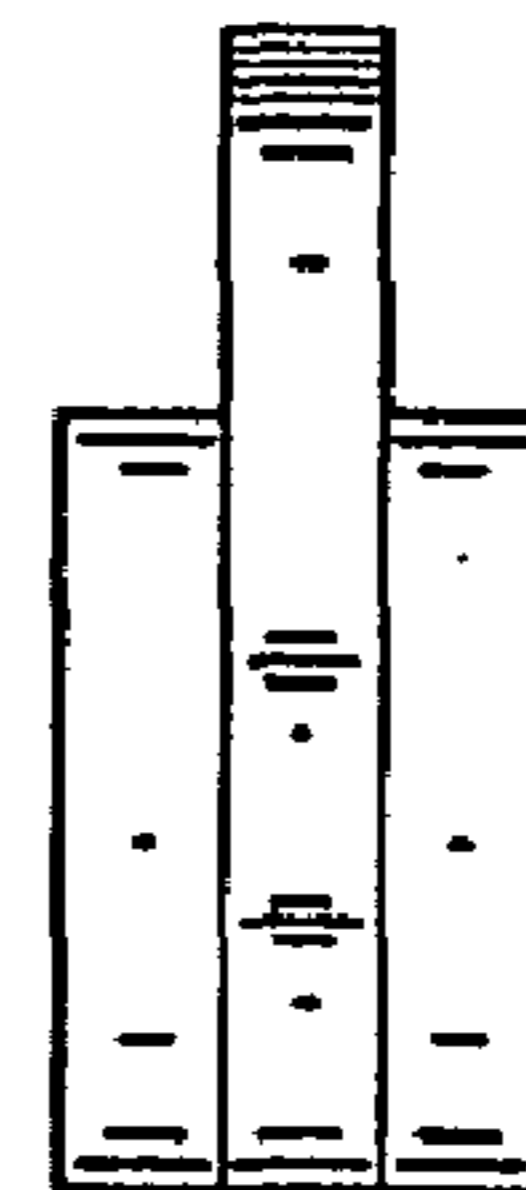

FIG. 18

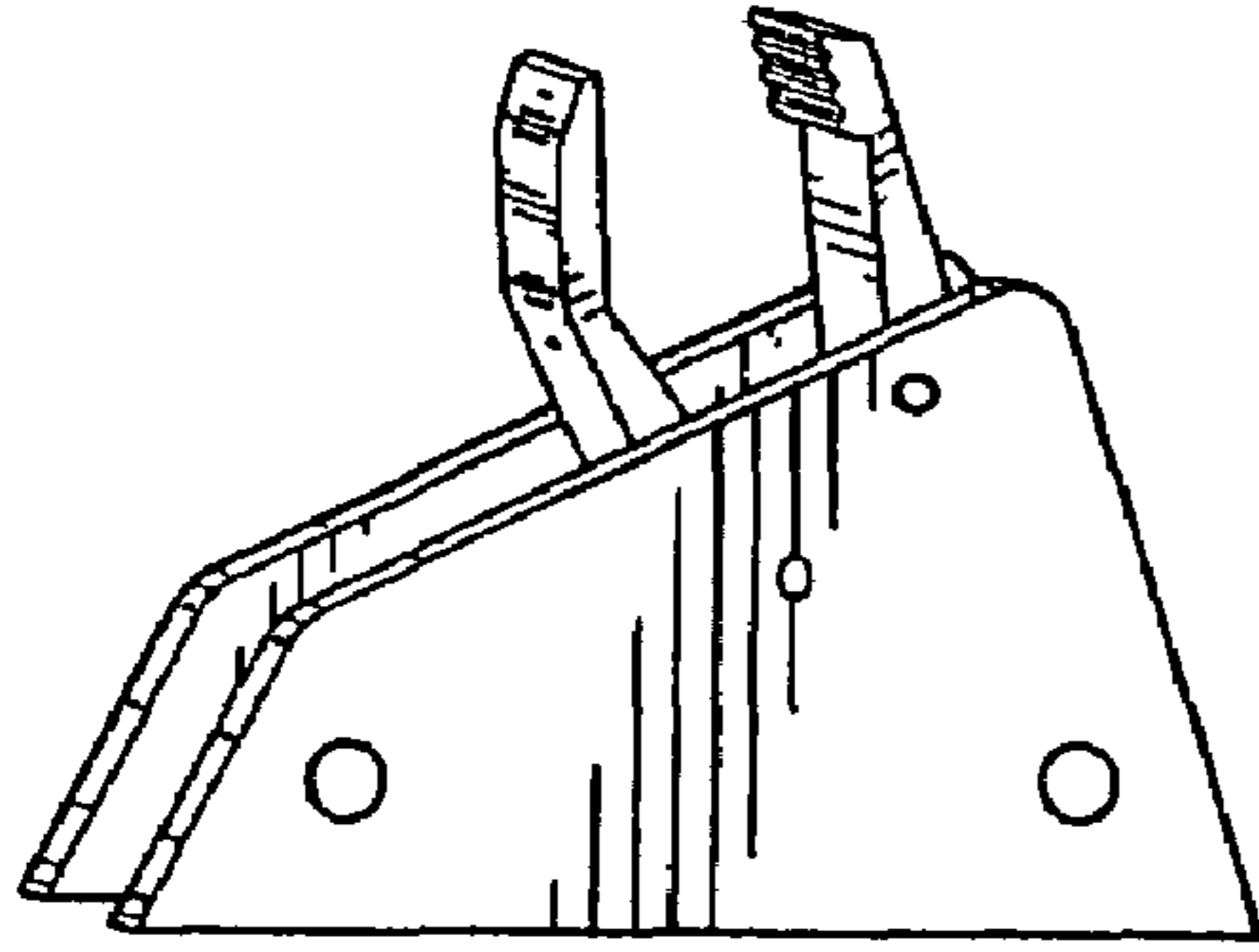

FIG. 19

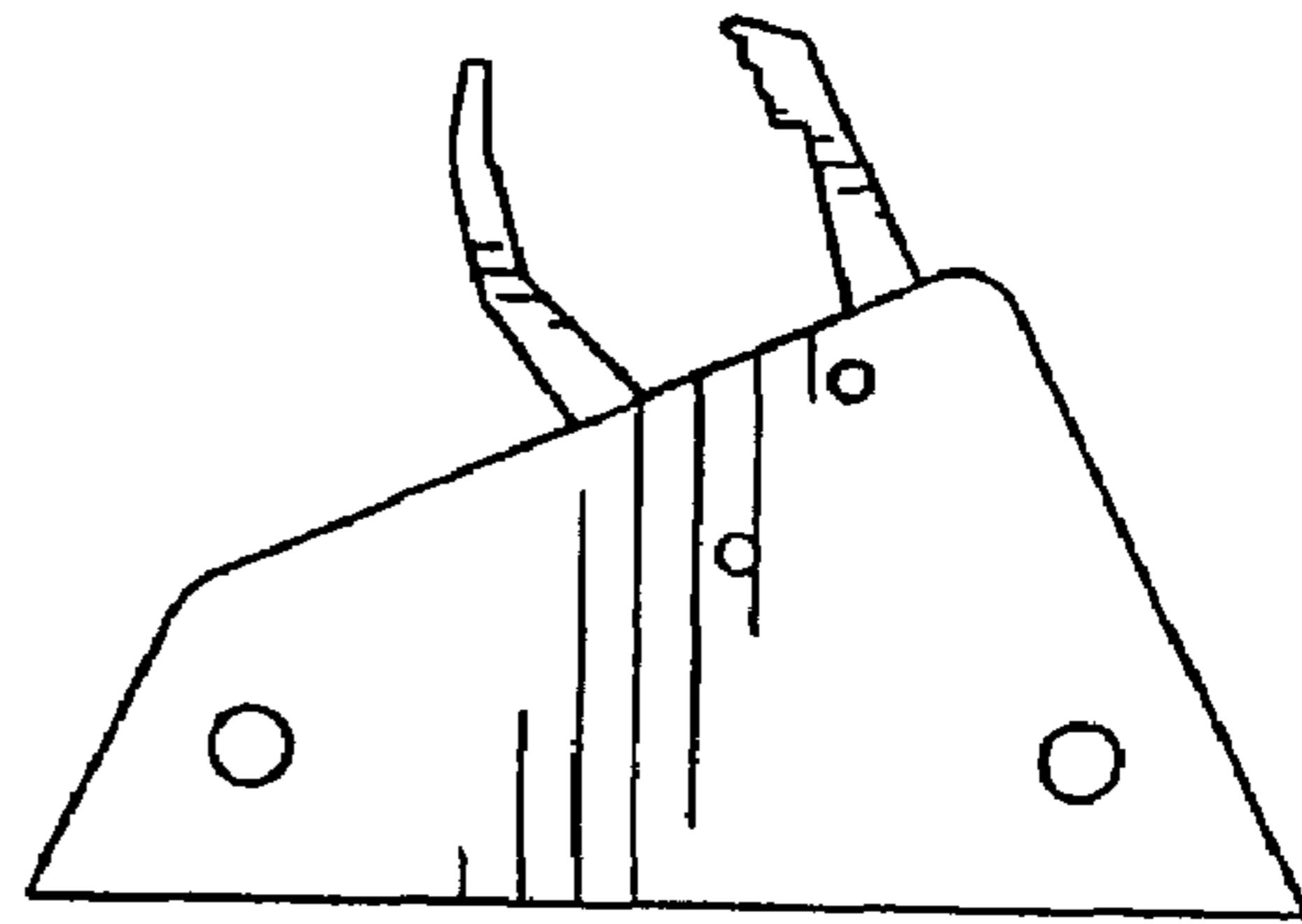

FIG. 20

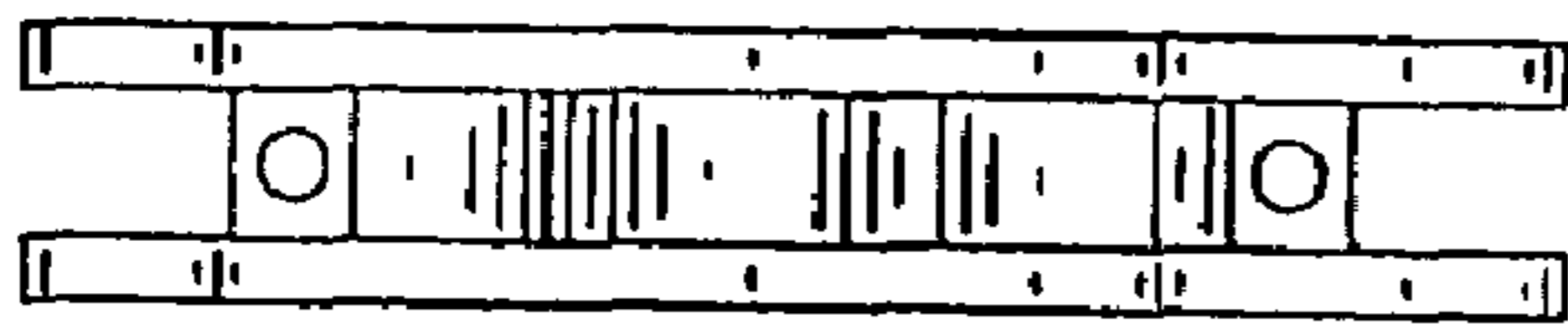

FIG. 21

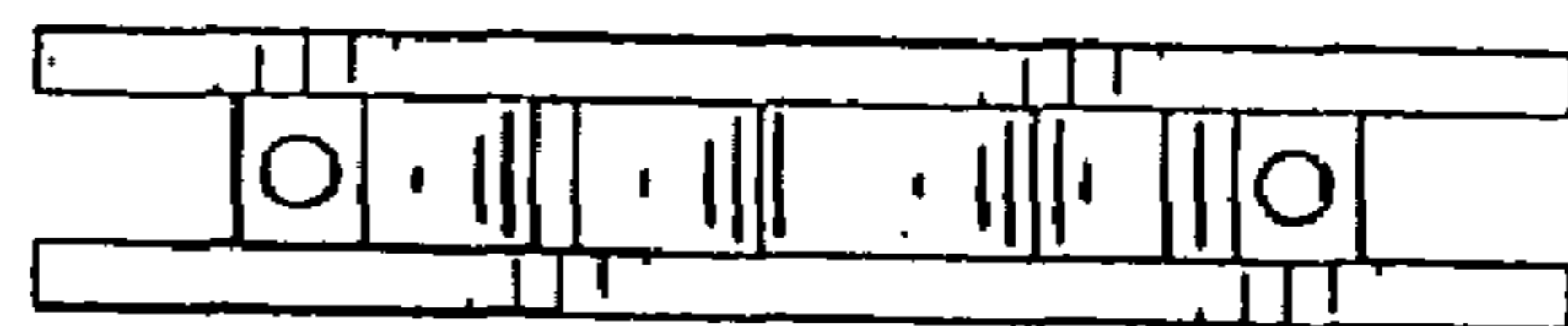

FIG. 22

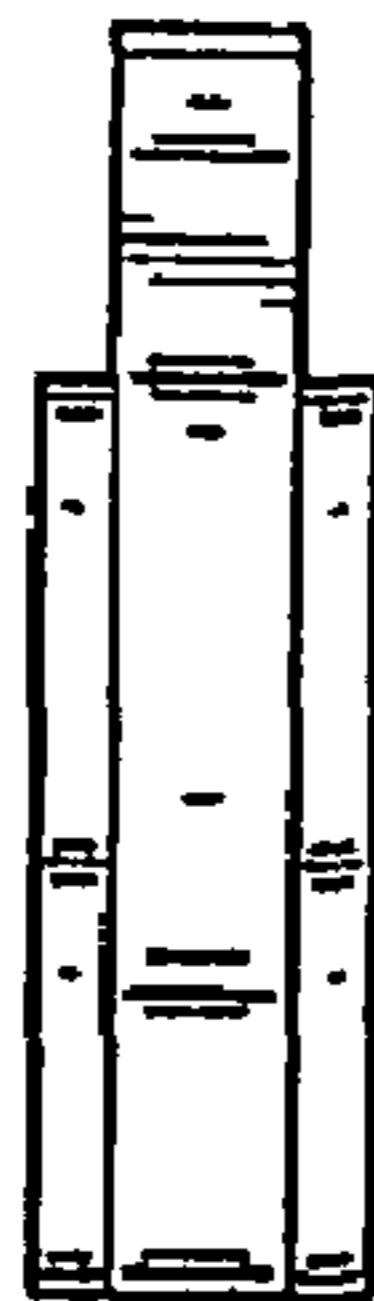

FIG. 23



FIG. 24