



US00D555825S

(12) **United States Design Patent**  
**Lecluze**

(10) **Patent No.:** **US D555,825 S**

(45) **Date of Patent:** **\*\* Nov. 20, 2007**

(54) **TRIM FOR LIGHT FIXTURE**

(75) Inventor: **Michel Lecluze**, St-Jean-Chrysostome (CA)

(73) Assignee: **Eclairage Contraste**, St-Jean-Chrysostome (CA)

(\*\*) Term: **14 Years**

(21) Appl. No.: **29/219,897**

(22) Filed: **Dec. 27, 2004**

(51) **LOC (8) Cl.** ..... **26-99**

(52) **U.S. Cl.** ..... **D26/138**

(58) **Field of Classification Search** ..... D26/119,  
D26/118, 74, 72, 75, 120, 131, 138, 152,  
D26/67, 42, 46, 81, 83, 113, 123, 124, 128,  
D26/137, 115; 362/147, 362, 404-408, 364,  
362/365, 296, 346, 366, 275, 257, 260, 433,  
362/434

See application file for complete search history.

(56) **References Cited**

**U.S. PATENT DOCUMENTS**

D247,562 S *	3/1978	Walker et al.	.....	D14/209
D326,729 S *	6/1992	Gattari	.....	D26/74
D347,292 S *	5/1994	Roos et al.	.....	D26/118
D370,550 S *	6/1996	Lecluze	.....	D26/118
D376,667 S *	12/1996	Lucluze	.....	D26/119
D380,852 S *	7/1997	Lecluze	.....	D26/118
D381,111 S *	7/1997	Lecluze	.....	D26/118
D381,454 S *	7/1997	Lecluze	.....	D26/118
D383,564 S *	9/1997	Lecluze	.....	D26/118
5,673,997 A *	10/1997	Akiyama	.....	362/147
D386,277 S *	11/1997	Lecluze	.....	D26/74
D387,466 S *	12/1997	Lecluze	.....	D26/118
D397,472 S *	8/1998	Lecluze	.....	D26/118
D397,490 S *	8/1998	Lecluze	.....	D26/118
D399,590 S *	10/1998	Lecluze	.....	D26/118
D407,524 S *	3/1999	Lecluze	.....	D26/118
6,425,680 B1 *	7/2002	Rippel et al.	.....	362/364

D473,965 S *	4/2003	Lecluze	.....	D26/74
D473,966 S *	4/2003	Lecluze	.....	D26/74
D474,298 S *	5/2003	Lecluze	.....	D26/74
D474,299 S *	5/2003	Lecluze	.....	D26/74
D474,300 S *	5/2003	Lecluze	.....	D26/74
D476,108 S *	6/2003	Lecluze	.....	D26/74
D487,816 S *	3/2004	Benghozi	.....	D26/118
D488,583 S *	4/2004	Benghozi	.....	D26/118
2001/0030865 A1 *	10/2001	Glowach et al.	.....	362/294

\* cited by examiner

*Primary Examiner*—Freda S. Nunn

*Assistant Examiner*—Kevin K. Rudzinski

(74) *Attorney, Agent, or Firm*—Goudreau Gage Dubuc

(57) **CLAIM**

The ornamental design for a trim for a light fixture, as shown and described.

**DESCRIPTION**

FIG. 1 is a perspective view of a first embodiment of the trim for light fixture showing my new design;

FIG. 2 is a bottom view thereof;

FIG. 3 is a side view thereof;

FIG. 4 is another side view thereof at 90° to that of FIG. 3;

FIG. 5 is an opposite side view thereof at 180° to that of FIG. 3;

FIG. 6 is a top plan view thereof;

FIG. 7 is a perspective view of a second embodiment of the trim for light fixture;

FIG. 8 is a bottom view thereof;

FIG. 9 is a side view thereof;

FIG. 10 is another side view thereof at 90° to that of FIG. 9;

FIG. 11 is an opposite side view thereof at 180° to that of FIG. 9; and,

FIG. 12 is a top plan view thereof.

**1 Claim, 6 Drawing Sheets**

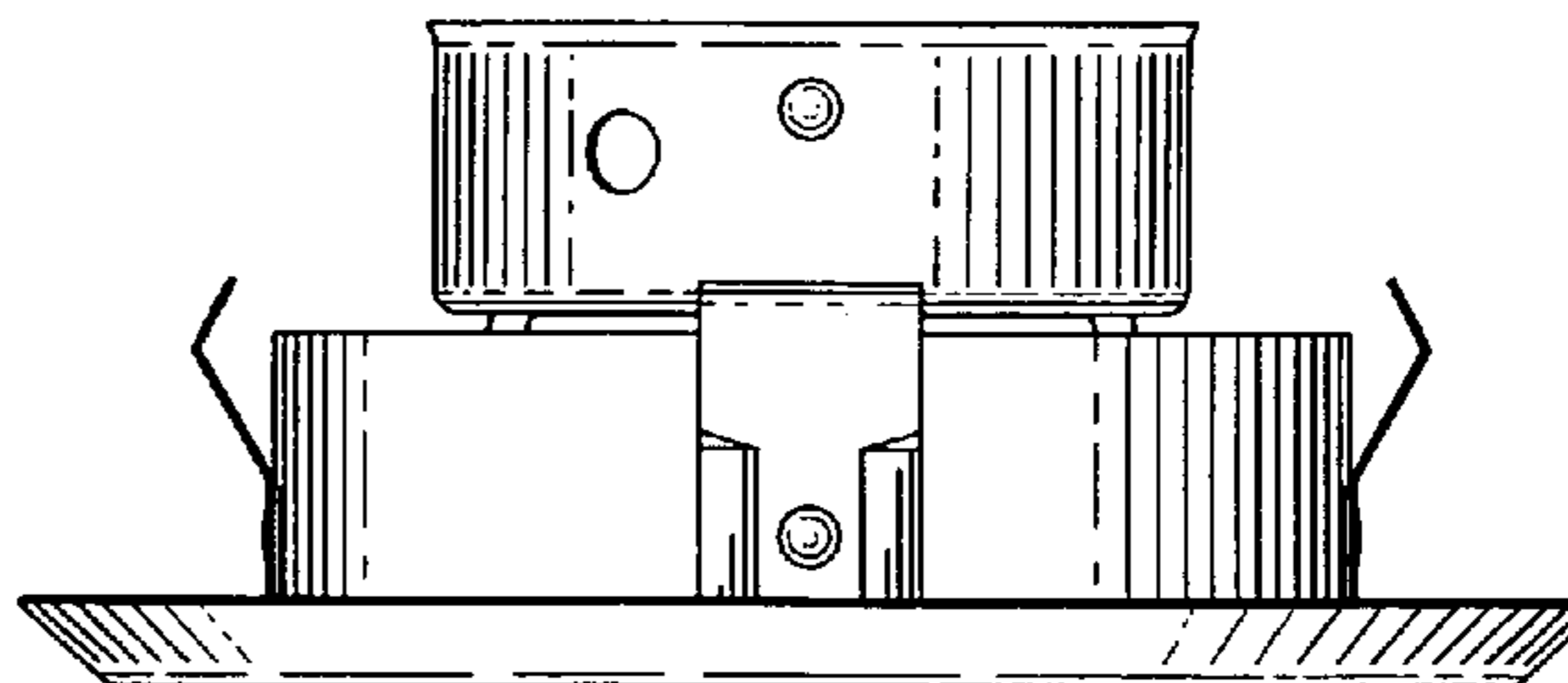
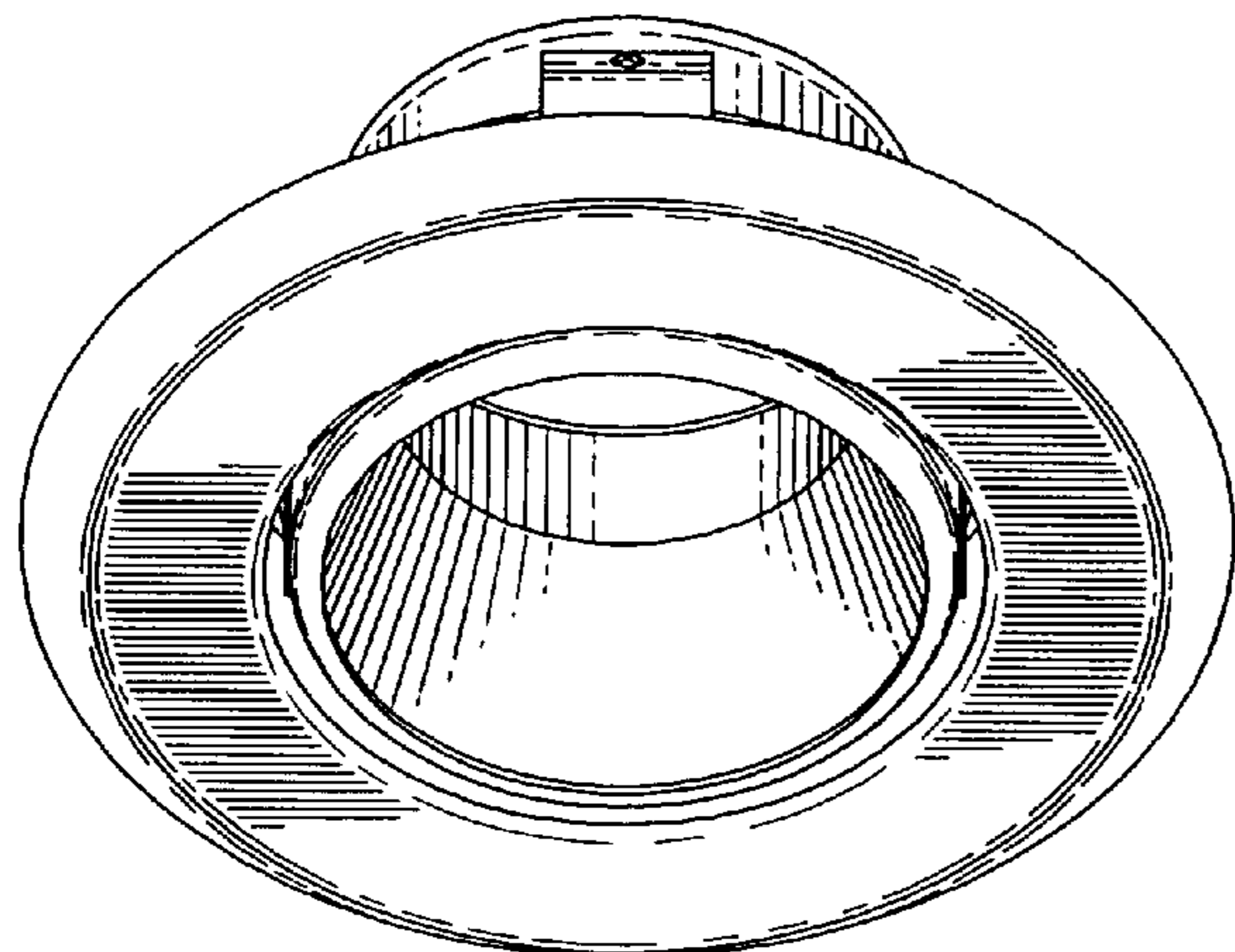

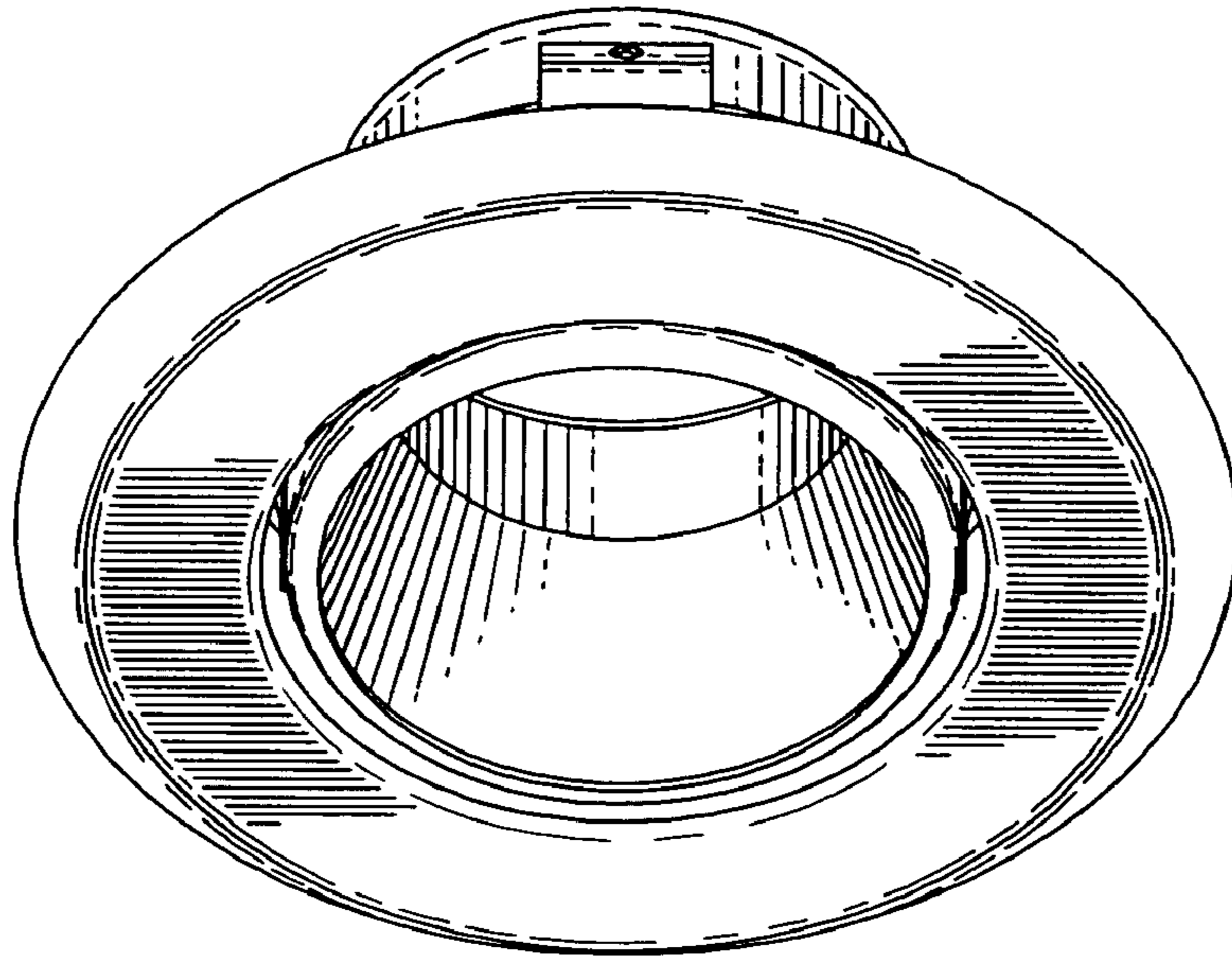

Fig-1

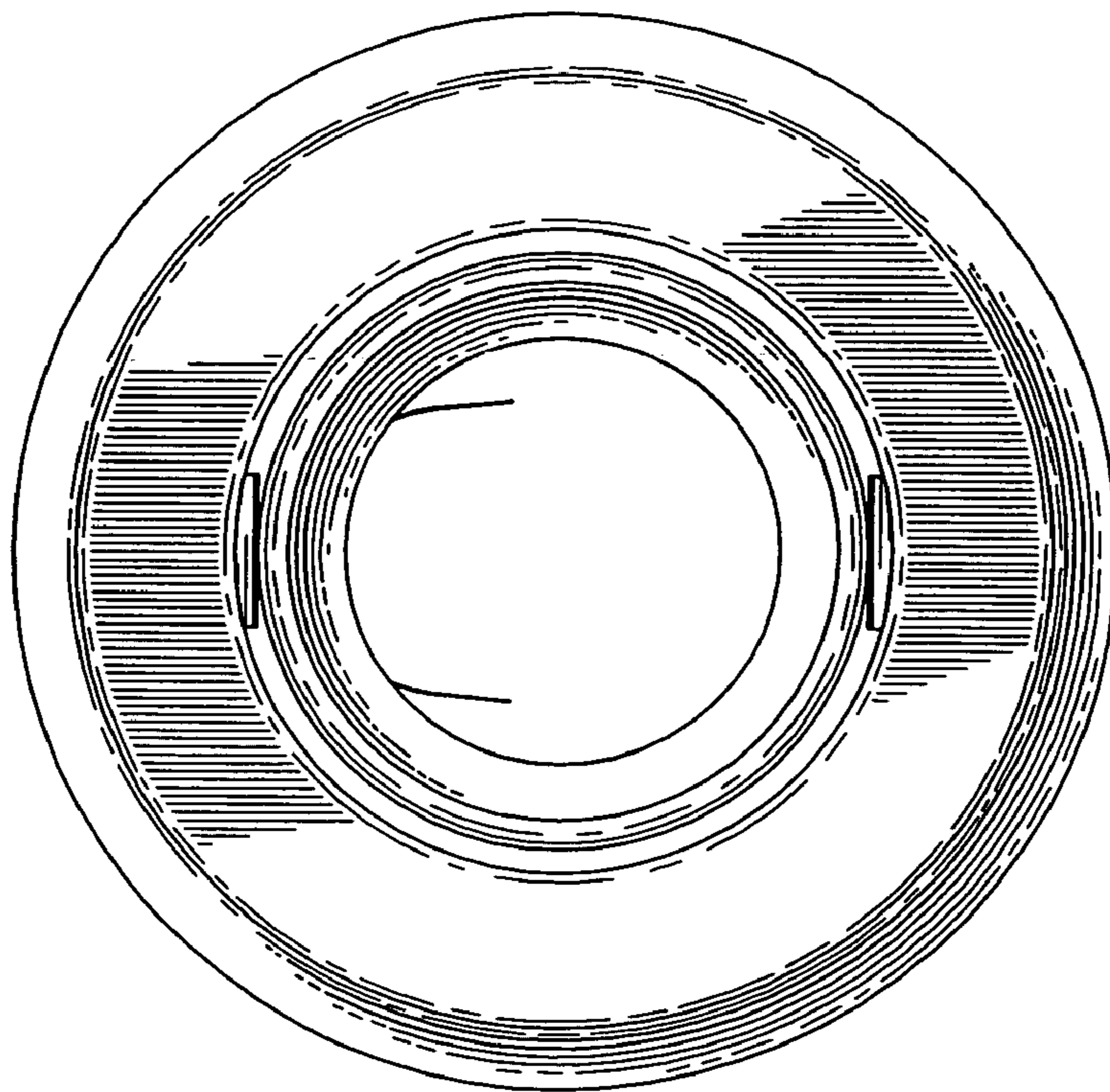

Fig-2

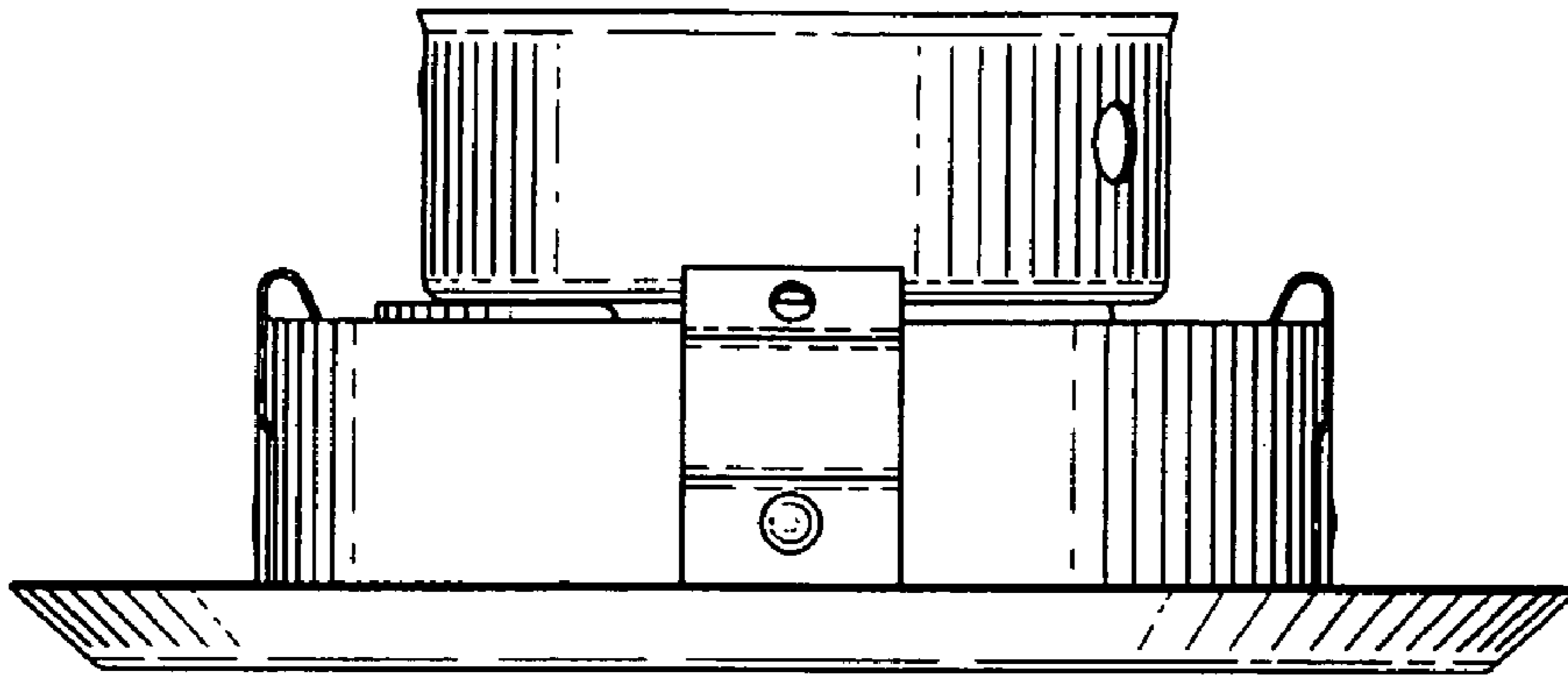

Fig-3

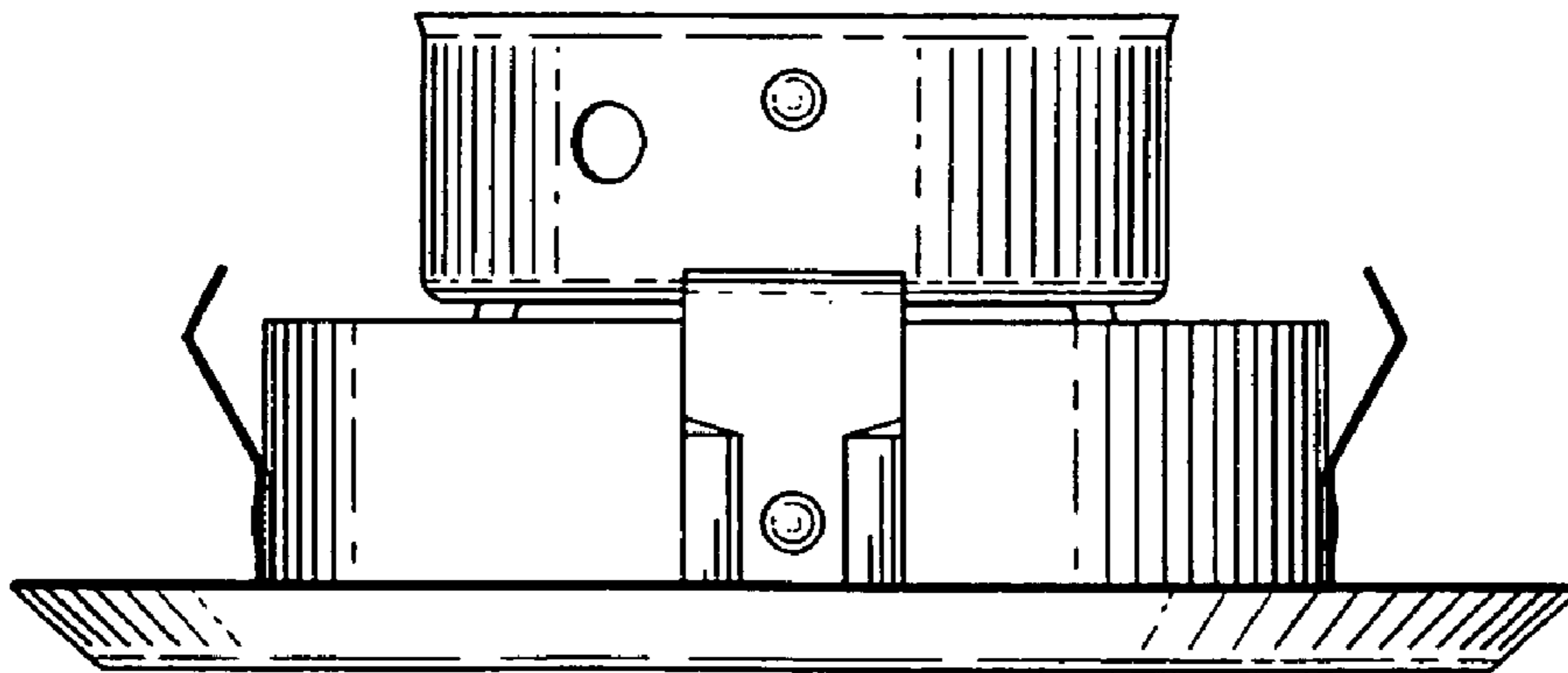

Fig-4

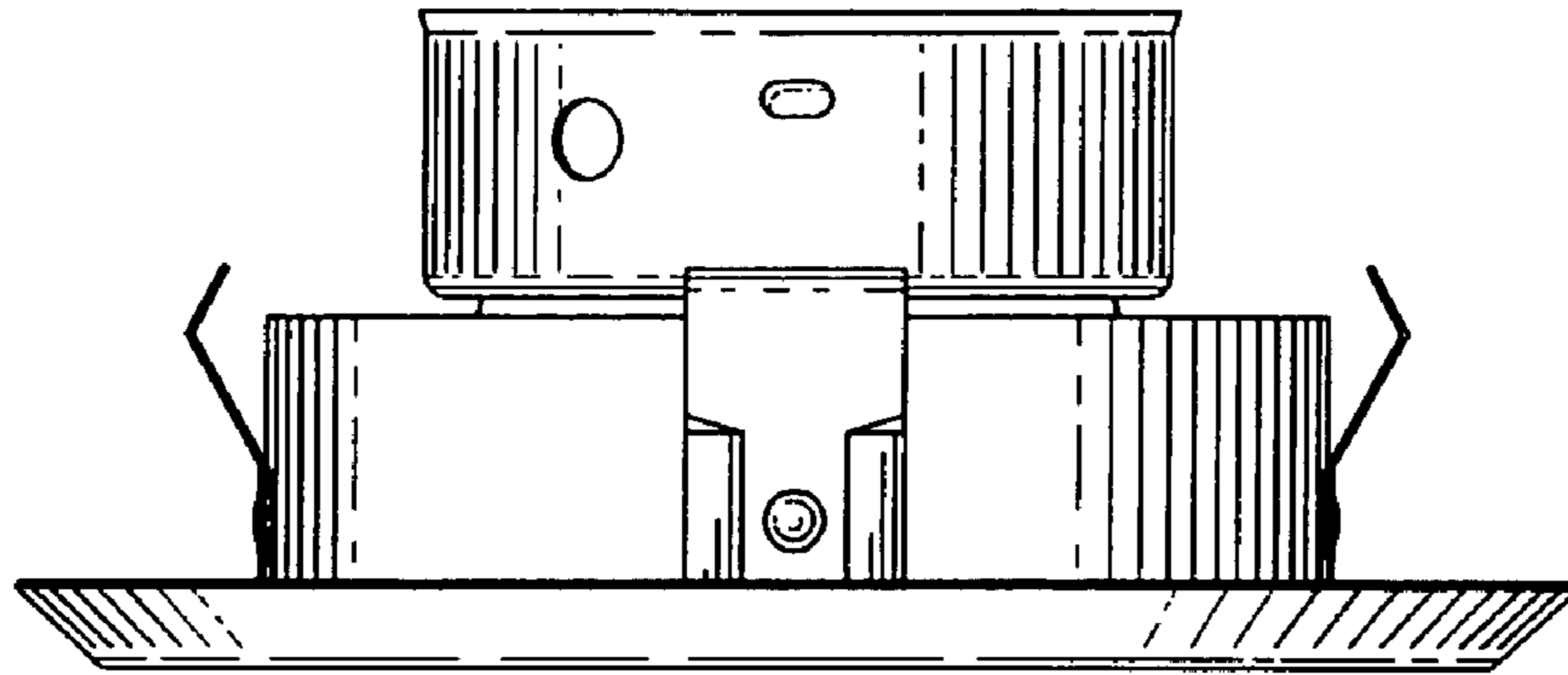

Fig. 5

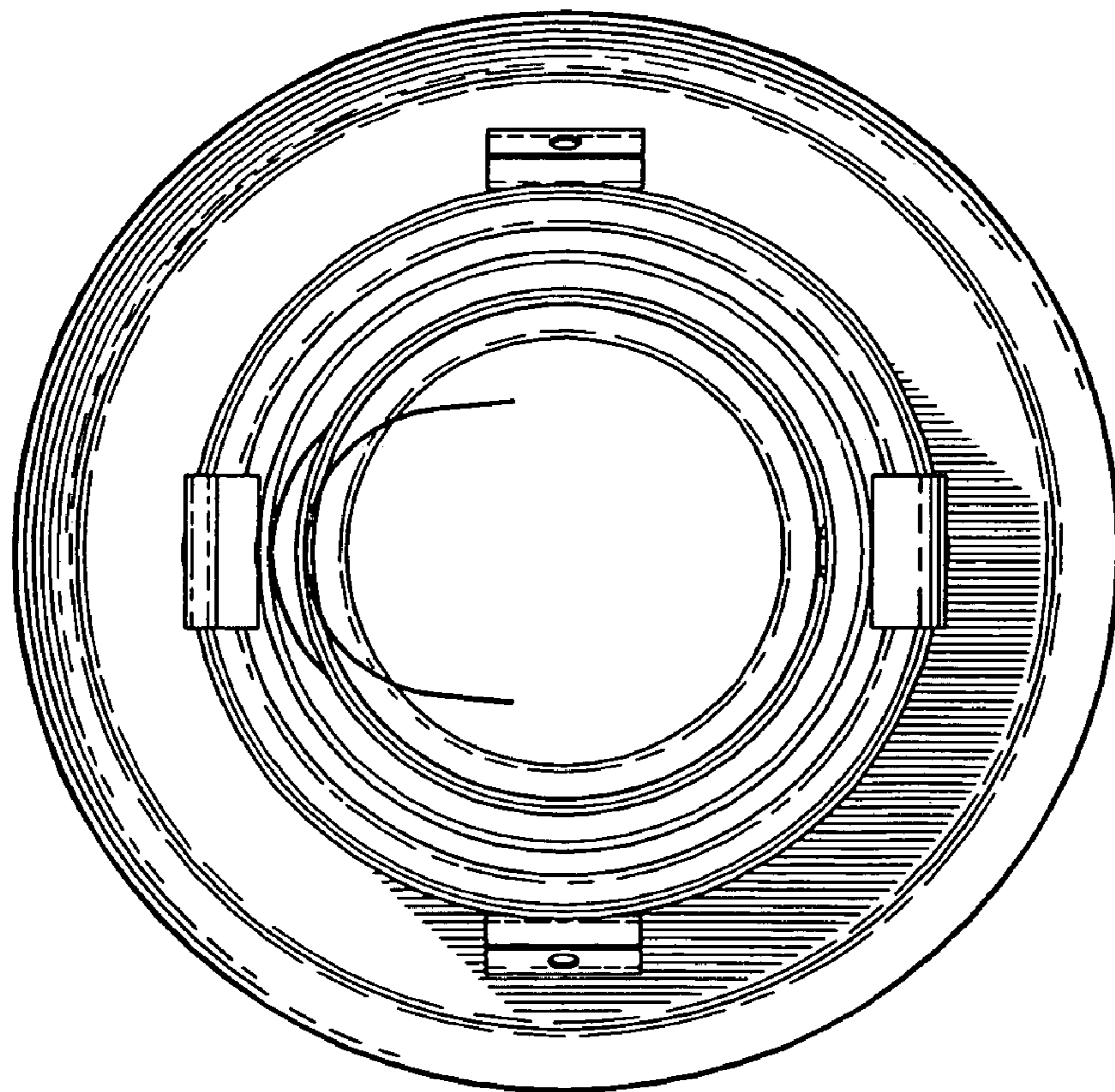

Fig. 6

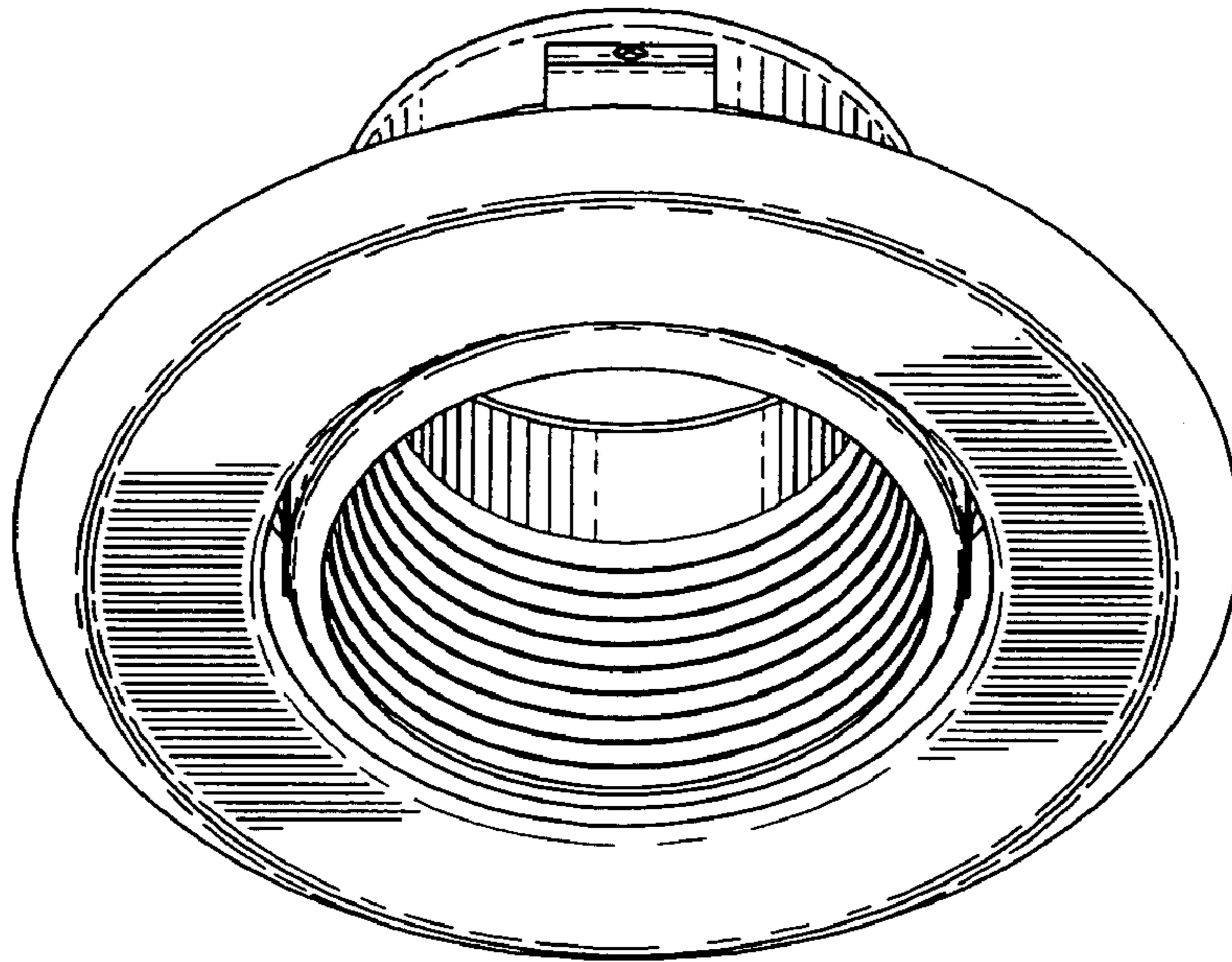

Fig-7

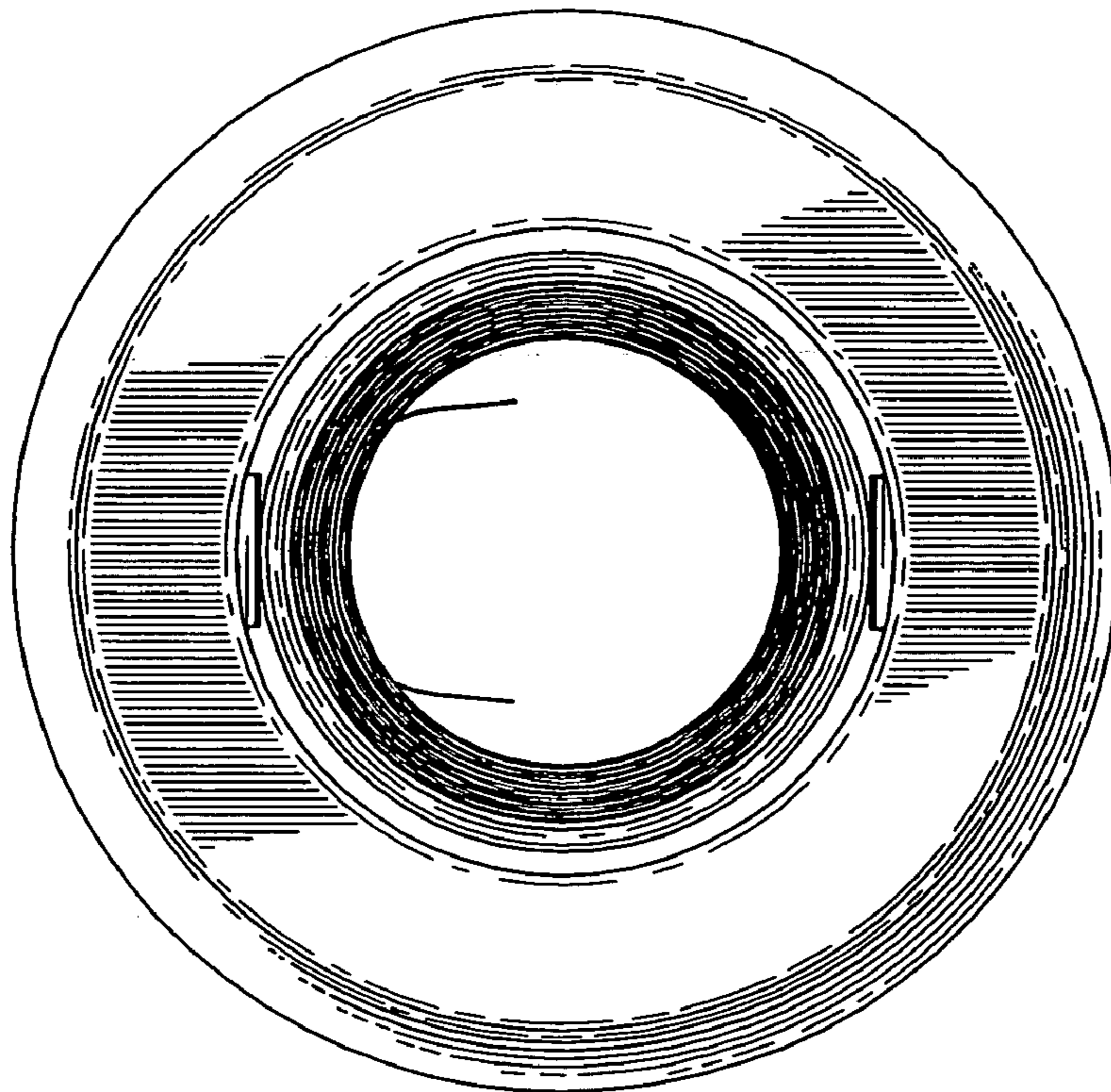

Fig-8

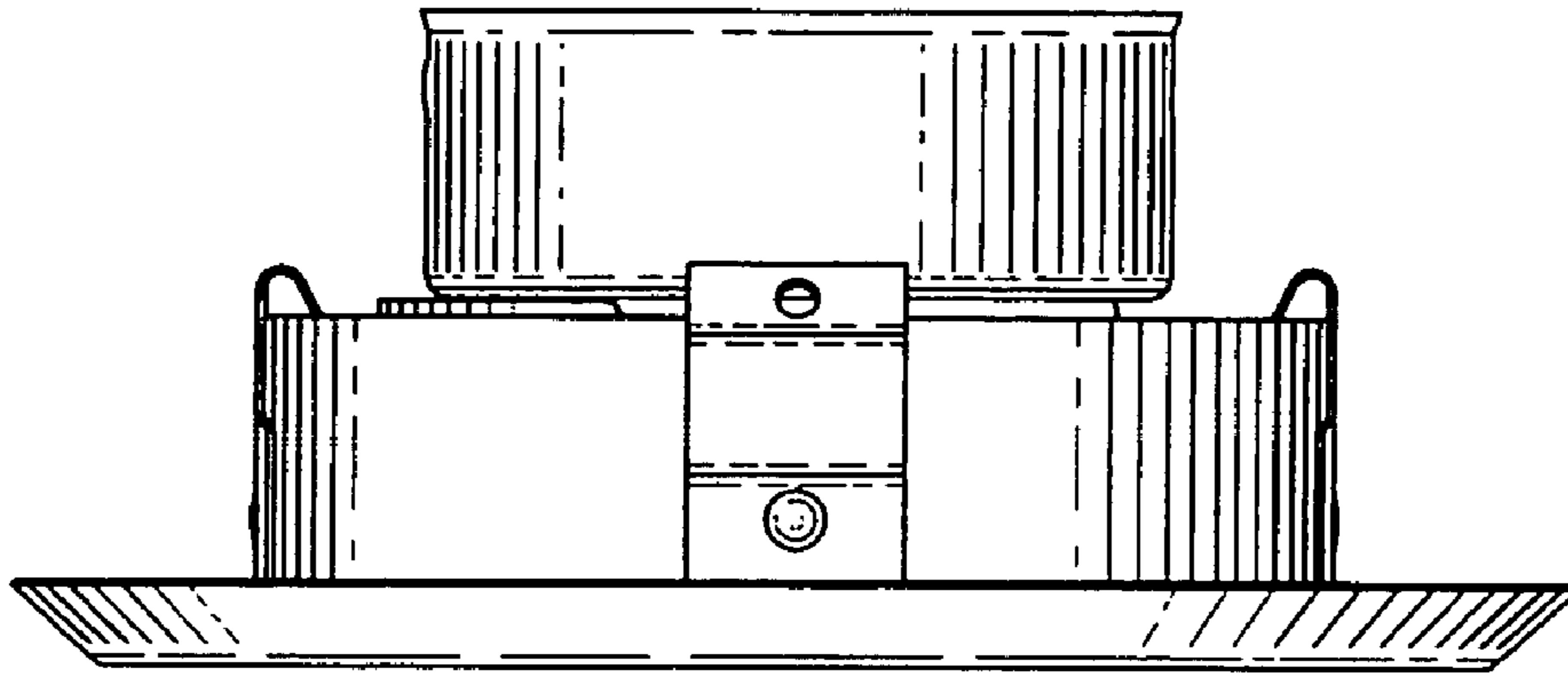

Fig-9

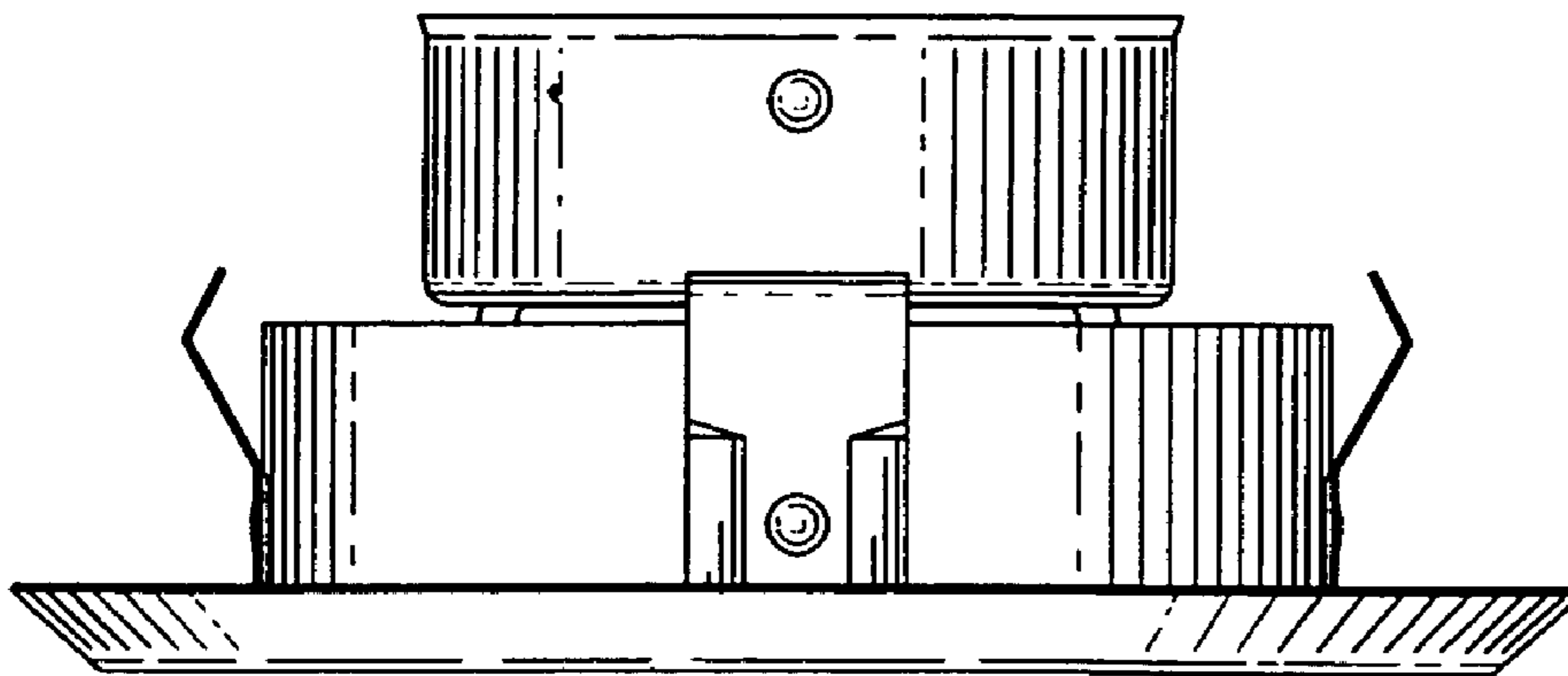
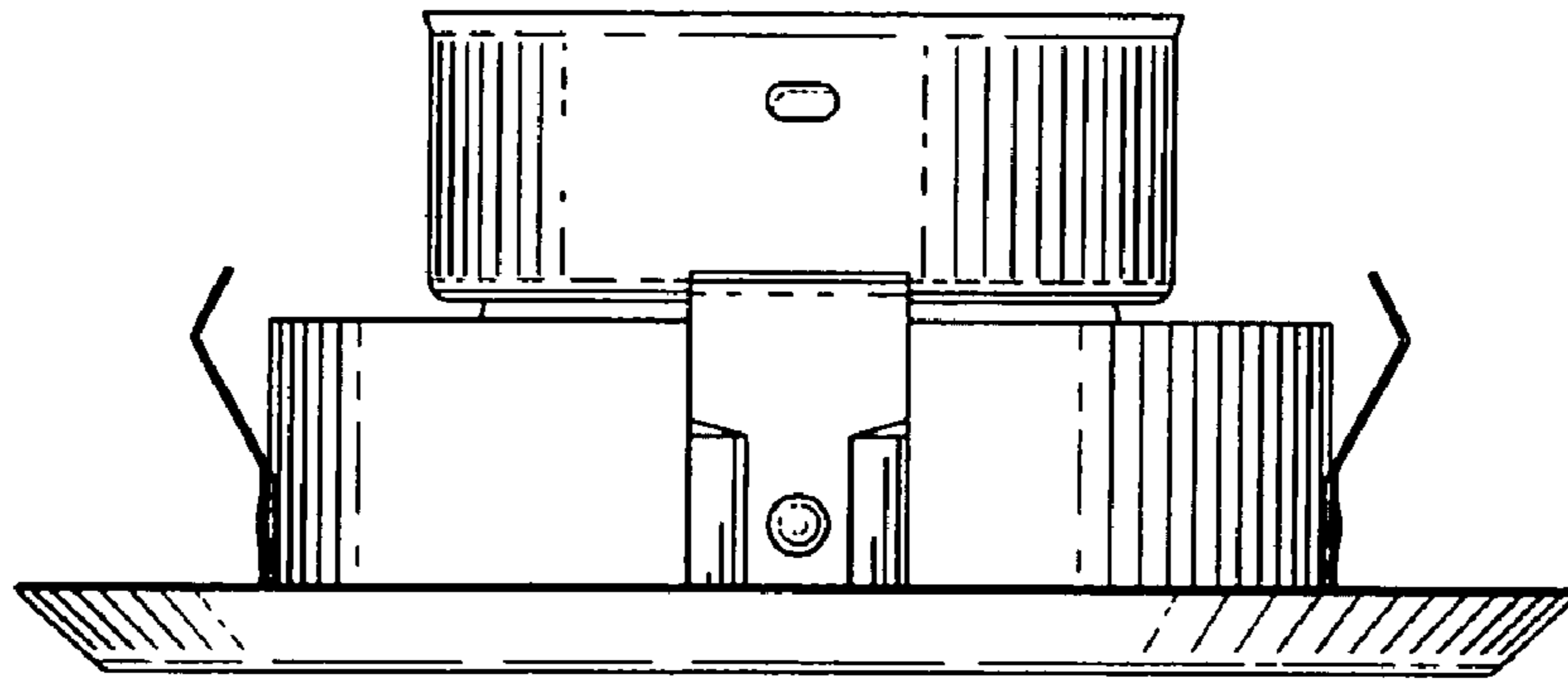
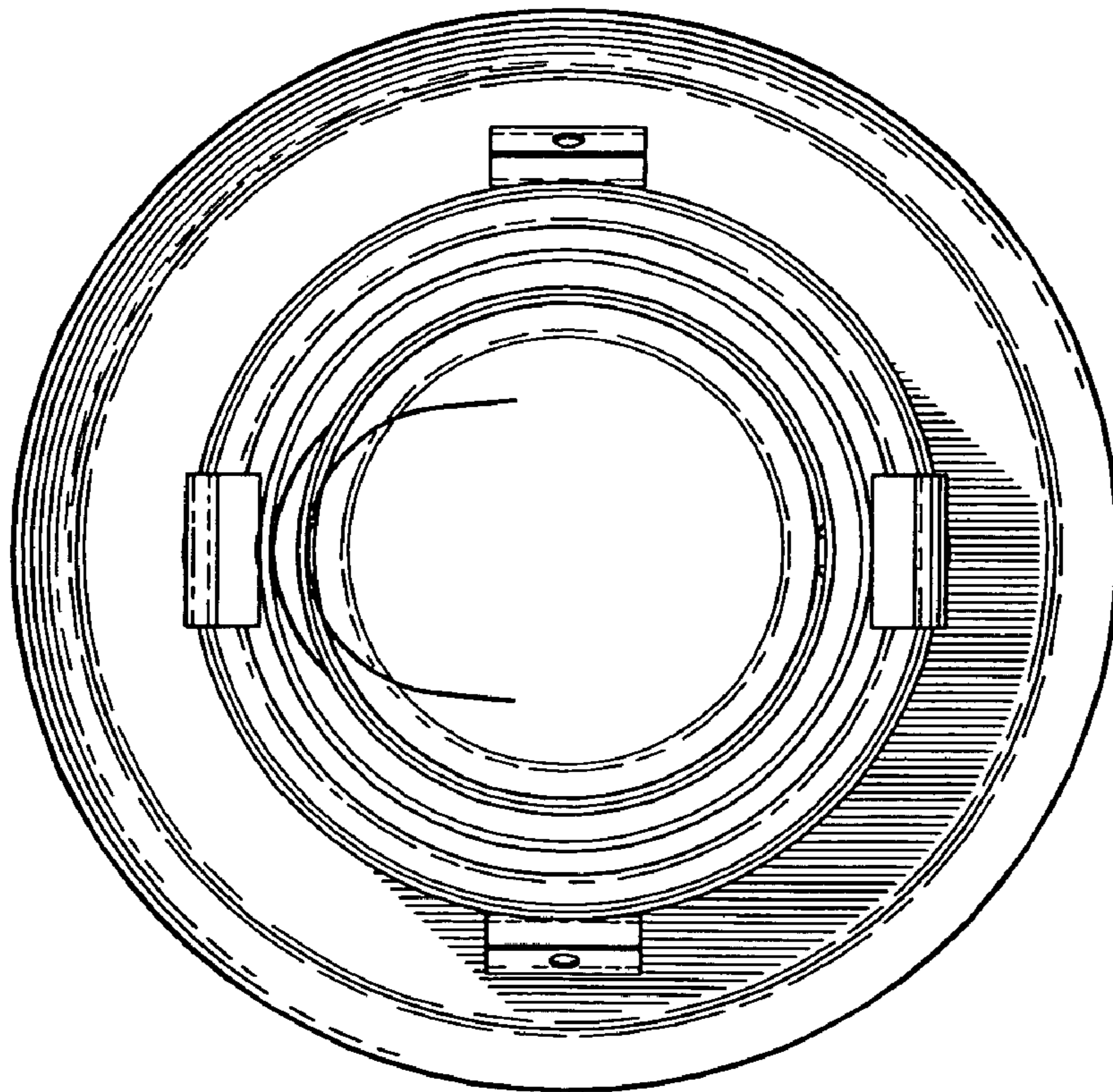

Fig-10



*Fig-11*



*Fig-12*