



US00D555794S

(12) **United States Design Patent** (10) **Patent No.:** **US D555,794 S**  
**Roleder et al.** (45) **Date of Patent:** **\*\* Nov. 20, 2007**

(54) **KNEEPAD PAIR DESIGN**

(74) *Attorney, Agent, or Firm*—Steven G. Roeder; James P. Broder

(75) Inventors: **Jon Roleder**, San Diego, CA (US);  
**Richard Estrada**, Oceanside, CA (US)

(57) **CLAIM**

(73) Assignee: **Earthlite Massage Tables, Inc.**, Vista, CA (US)

The ornamental design for kneepad pair design, as shown and described.

(\*\*) Term: **14 Years**

**DESCRIPTION**

(21) Appl. No.: **29/232,244**

(22) Filed: **Jun. 16, 2005**

(51) **LOC (8) Cl.** ..... **24-01**

(52) **U.S. Cl.** ..... **D24/184**

(58) **Field of Classification Search** ..... D24/183–184;  
D6/334–335, 340, 354, 360, 367, 500–502;  
D29/121.1; 297/195.11, 195.12, 423.11,  
297/423.12; 5/613, 620, 622, 623, 638; 601/24,  
601/49

See application file for complete search history.

(56) **References Cited**

**U.S. PATENT DOCUMENTS**

3,227,414 A	1/1966	Dean
4,258,951 A	3/1981	Groom
4,290,643 A	9/1981	Logan, III
4,589,699 A	5/1986	Dungan
4,650,249 A	3/1987	Serber
4,746,167 A	5/1988	Palmer et al.

(Continued)

**OTHER PUBLICATIONS**

<http://piscespro.com/main.html>. These pages include pictures of a prior art massage chair sold by Pisces Productions.

<http://www.goldenratio.com/GRW/Chair/QuickLite.html>. These webpages include pictures of a prior art massage chair sold by Golden Ratio.

(Continued)

*Primary Examiner*—Robert A. Delehanty  
*Assistant Examiner*—Mark Cavanna

FIG. 1 is a perspective view of a portion of a massage chair showing our design of a kneepad pair design;

FIG. 2 is an alternative perspective view thereof;

FIG. 3 is a top perspective view of a left kneepad of the kneepad pair;

FIG. 4 is a bottom perspective view thereof;

FIG. 5 is a top view thereof;

FIG. 6 is a bottom view thereof;

FIG. 7 is a left side view thereof;

FIG. 8 is a right side view thereof;

FIG. 9 is a front side view thereof;

FIG. 10 is a rear side view thereof;

FIG. 11 is a top perspective view of a right kneepad of the kneepad pair;

FIG. 12 is a bottom perspective view thereof;

FIG. 13 is a top view thereof;

FIG. 14 is a bottom view thereof;

FIG. 15 is a left side view thereof;

FIG. 16 is a right side view thereof;

FIG. 17 is a front side view thereof; and,

FIG. 18 is a rear side view thereof.

The portion of the massage chair other than the left and right kneepads in FIGS. 1 and 2 is illustrative of environmental structure only and forms no part of the claimed design. This portion is illustrated in broken lines.

**1 Claim, 8 Drawing Sheets**

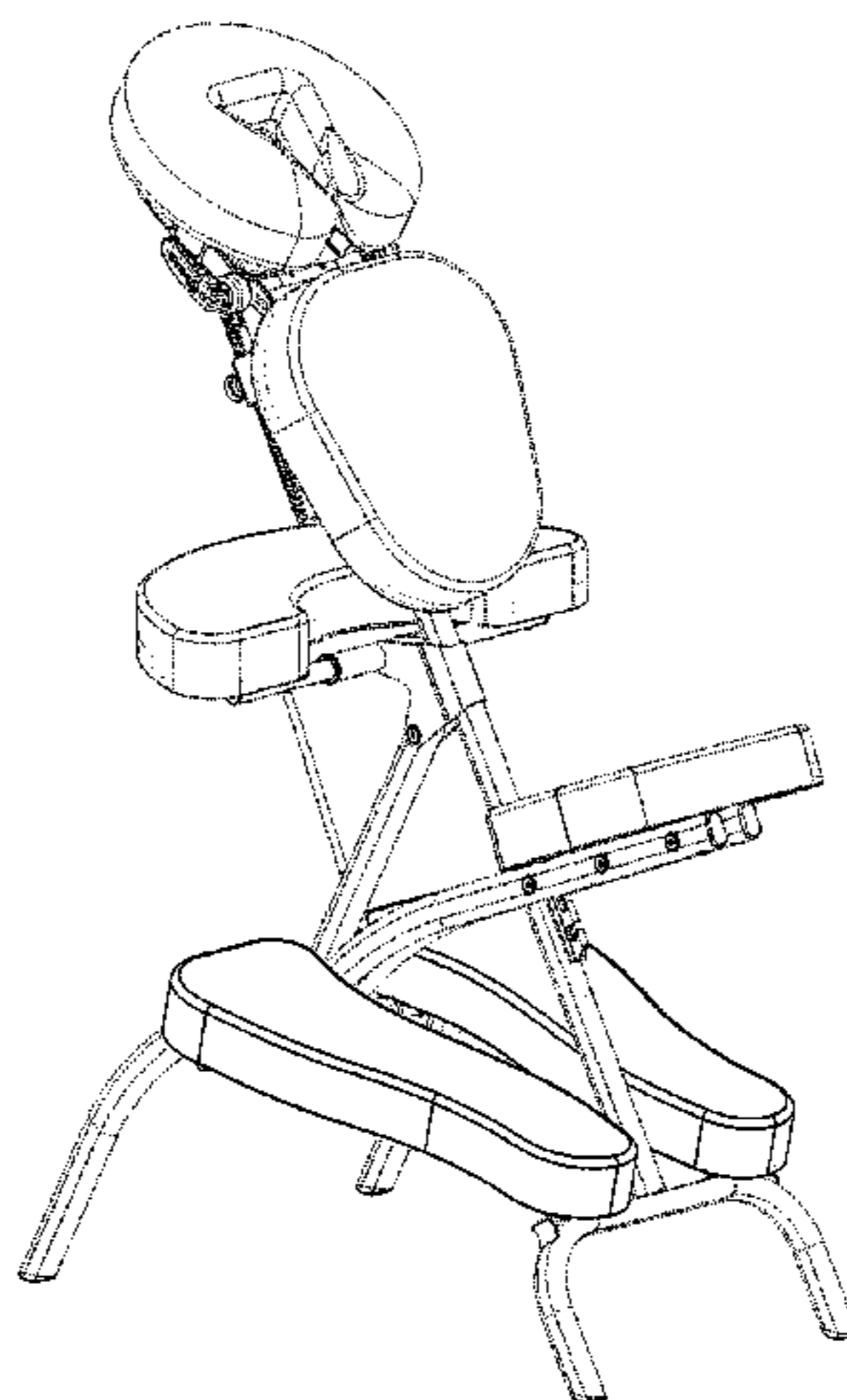

# US D555,794 S

Page 2

## U.S. PATENT DOCUMENTS

4,832,407 A 5/1989 Serber  
5,177,823 A 1/1993 Riach  
D334,982 S 4/1993 Riach  
5,295,728 A 3/1994 Schaevitz  
5,401,078 A \* 3/1995 Riach ..... 297/195.11  
5,427,436 A 6/1995 Lloyd  
5,460,430 A 10/1995 Miga, Jr. et al.  
5,487,590 A 1/1996 Haynes  
D369,691 S \* 5/1996 Haynes ..... D6/367  
5,542,746 A 8/1996 Bujaryn  
5,582,464 A 12/1996 Maymon  
5,667,278 A 9/1997 Li  
5,720,517 A 2/1998 Prothro, Sr.  
5,762,402 A 6/1998 Gillotti  
5,813,727 A 9/1998 Sugawa et al.  
5,921,696 A 7/1999 Gillotti  
5,943,965 A 8/1999 Riach et al.  
5,961,179 A 10/1999 Dixon et al.  
5,971,485 A \* 10/1999 Clark ..... 297/195.11  
6,065,808 A \* 5/2000 Tinsley ..... 297/195.11  
6,174,028 B1 1/2001 Yang et al.  
6,186,593 B1 2/2001 Garneau  
6,273,865 B1 \* 8/2001 Perez ..... 601/49

6,397,414 B1 6/2002 Lloyd  
6,412,738 B1 7/2002 Bressler et al.  
6,532,609 B2 \* 3/2003 Taylor et al. .... 5/613  
6,543,853 B1 \* 4/2003 Splane, Jr. .... 297/195.11  
6,698,831 B2 \* 3/2004 Lloyd ..... 297/195.11  
6,729,690 B2 \* 5/2004 Roleder et al. .... 297/423.12  
6,769,736 B2 \* 8/2004 Roleder et al. .... 297/195.11  
D516,254 S \* 2/2006 Shircliff ..... D29/121.1  
7,144,080 B2 \* 12/2006 Lloyd ..... 297/195.11  
2002/0067060 A1 \* 6/2002 Lloyd ..... 297/195.11  
2002/0067606 A1 6/2002 Lloyd

## OTHER PUBLICATIONS

[http://www.oakworks.net/portables/portal\\_pro.html](http://www.oakworks.net/portables/portal_pro.html). These webpages include pictures of a prior art massage chair sold by Oakworks, Inc.  
Earthlite Massage Tables, Inc. product brochure. This brochure includes pictures of prior art massage chairs sold by Earthlite Massage Tables, Inc.  
[http://www.mtso.ab.ca/product/\(a\)\\_Prolite\\_Chair.html](http://www.mtso.ab.ca/product/(a)_Prolite_Chair.html). This webpage includes a picture of a prior art massage chair sold by Massage Therapy Supply Outlet.

\* cited by examiner

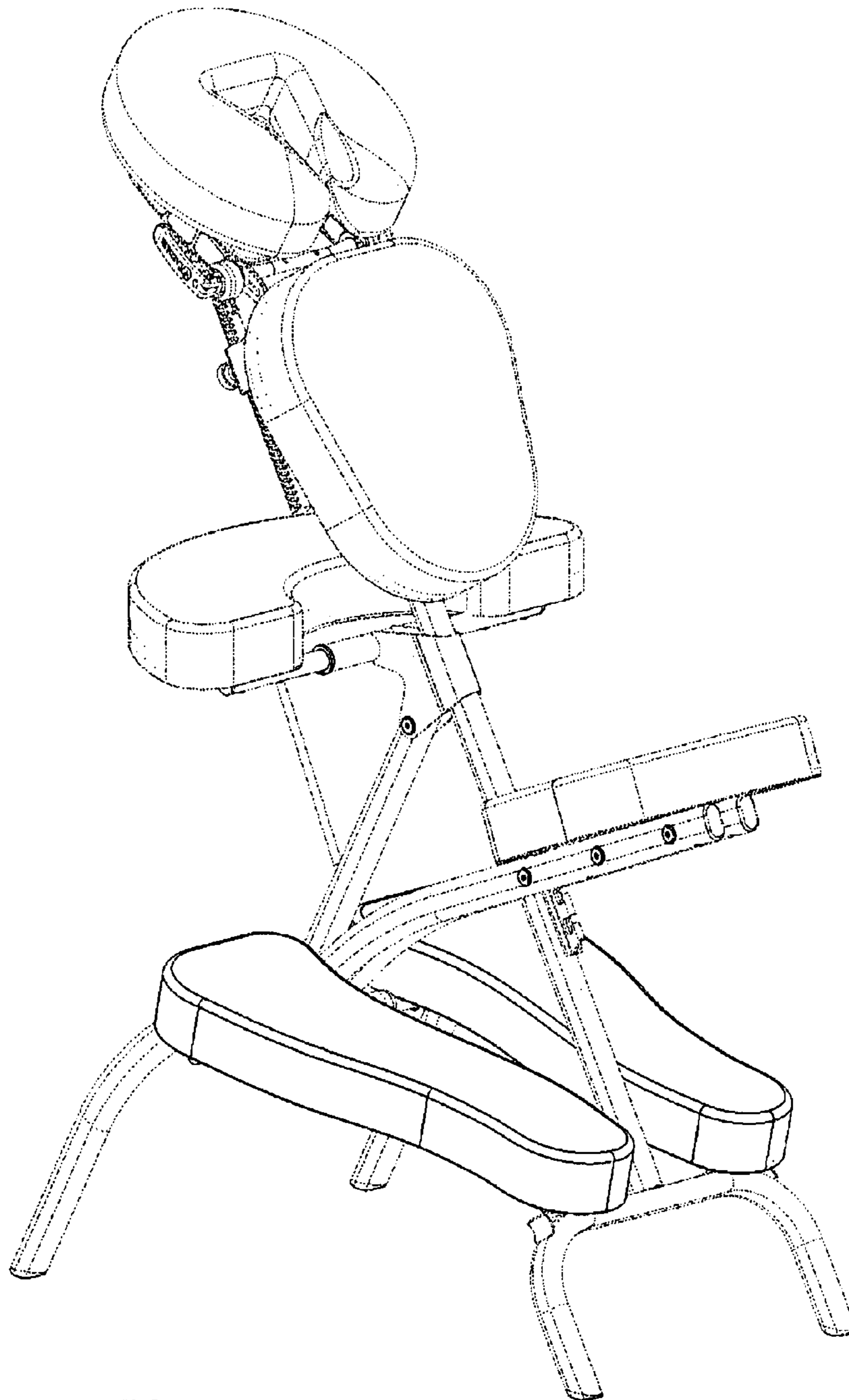

FIG. 1

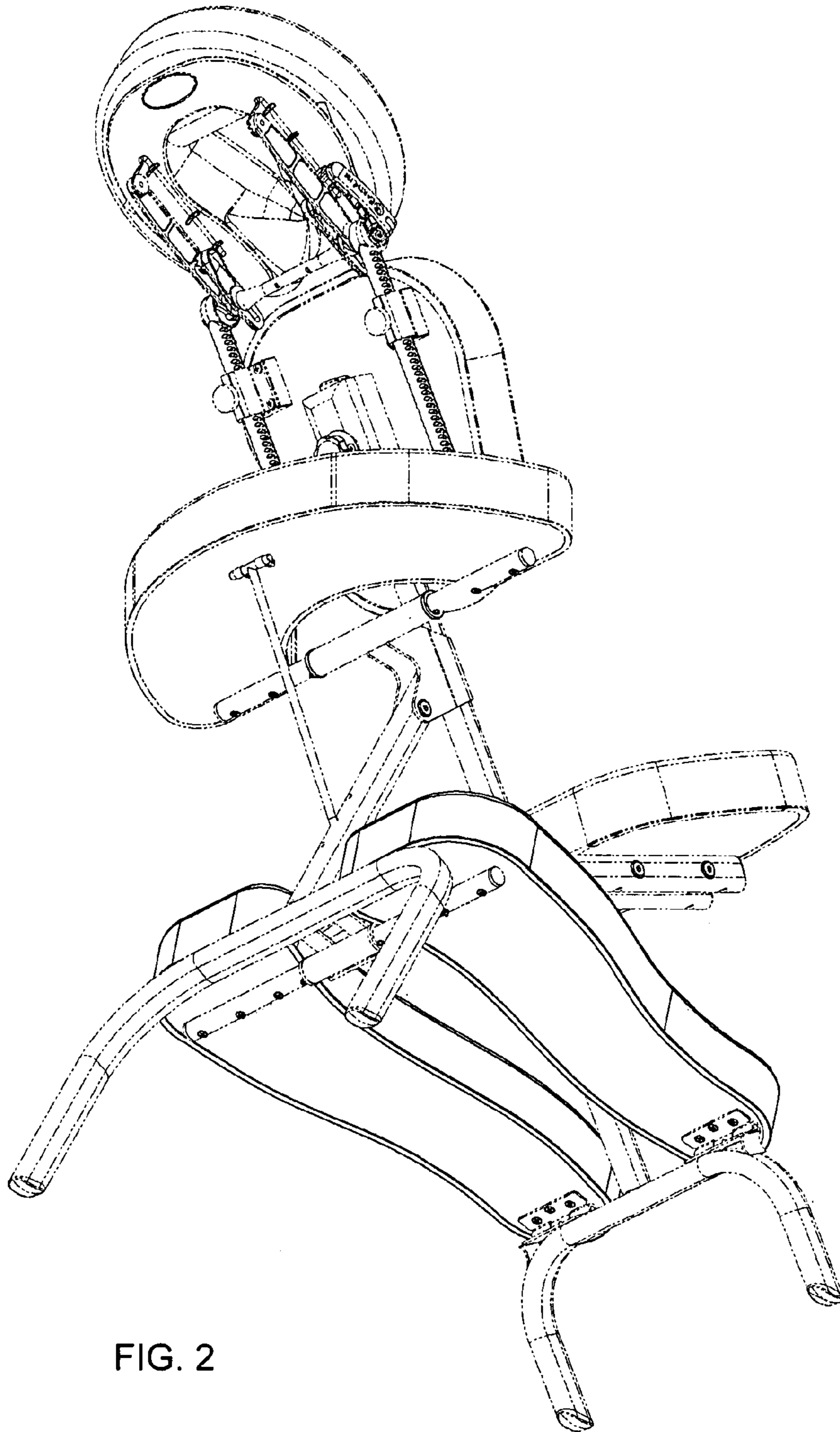

FIG. 2

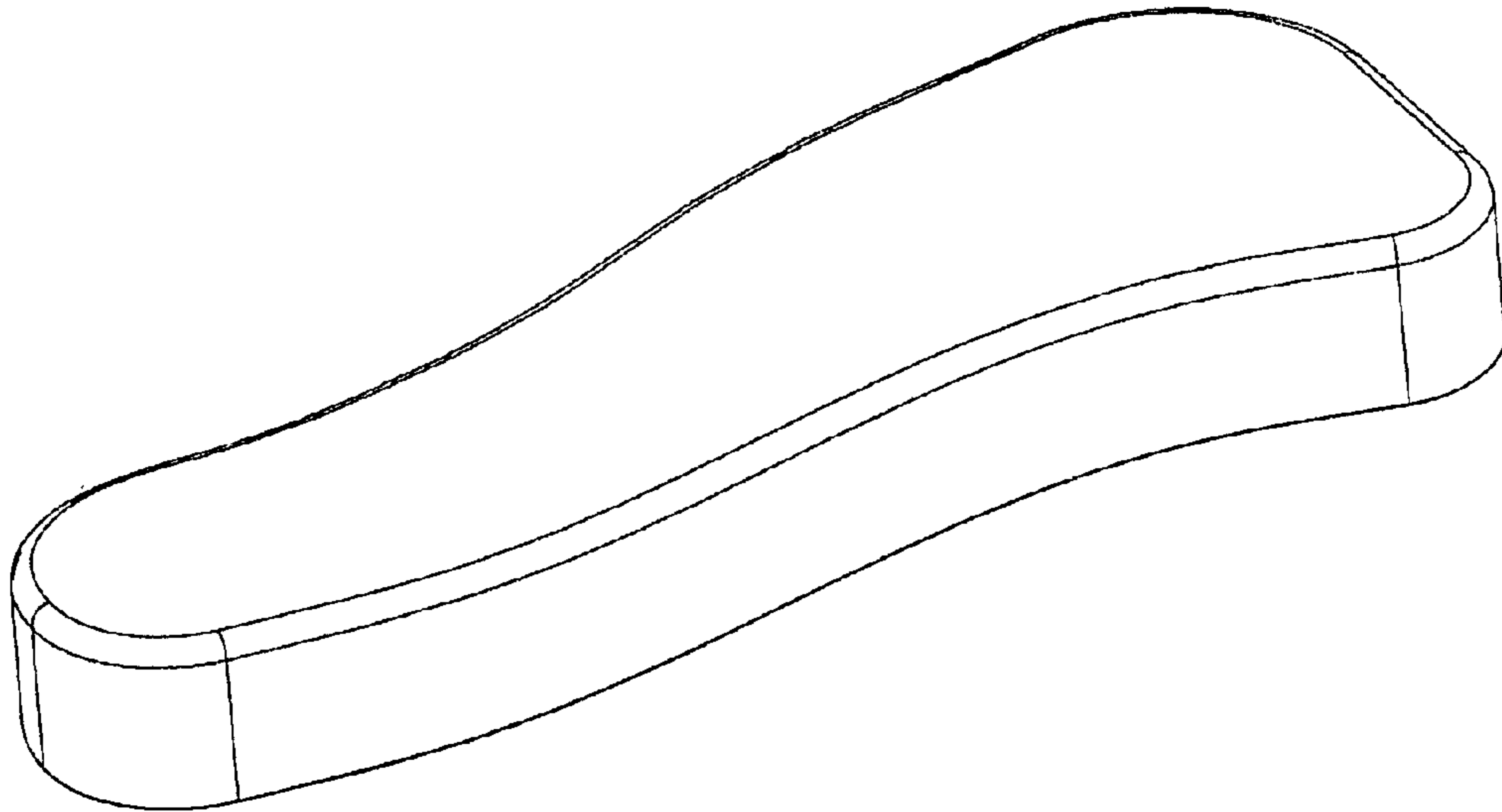

FIG. 3

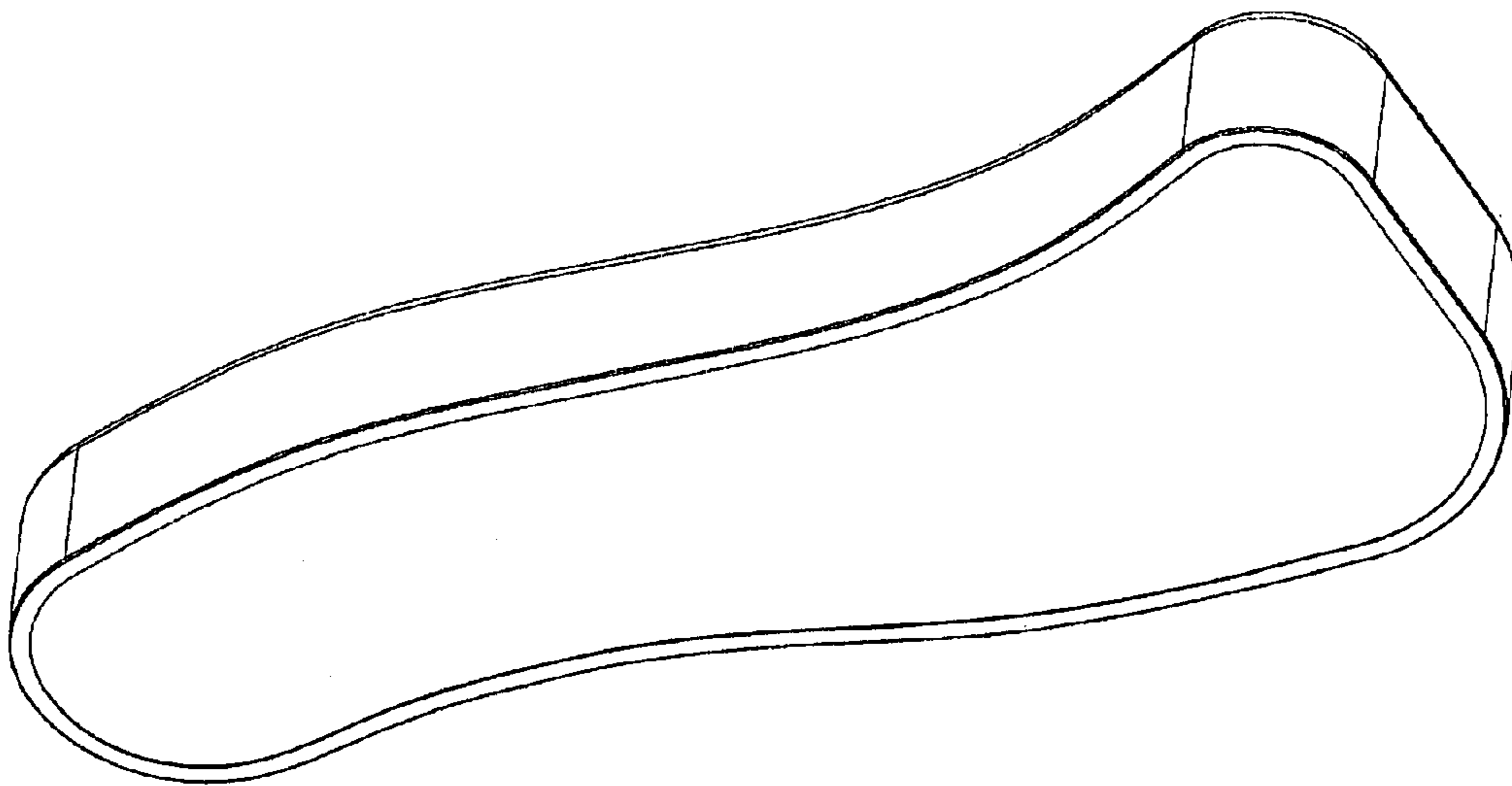

FIG. 4

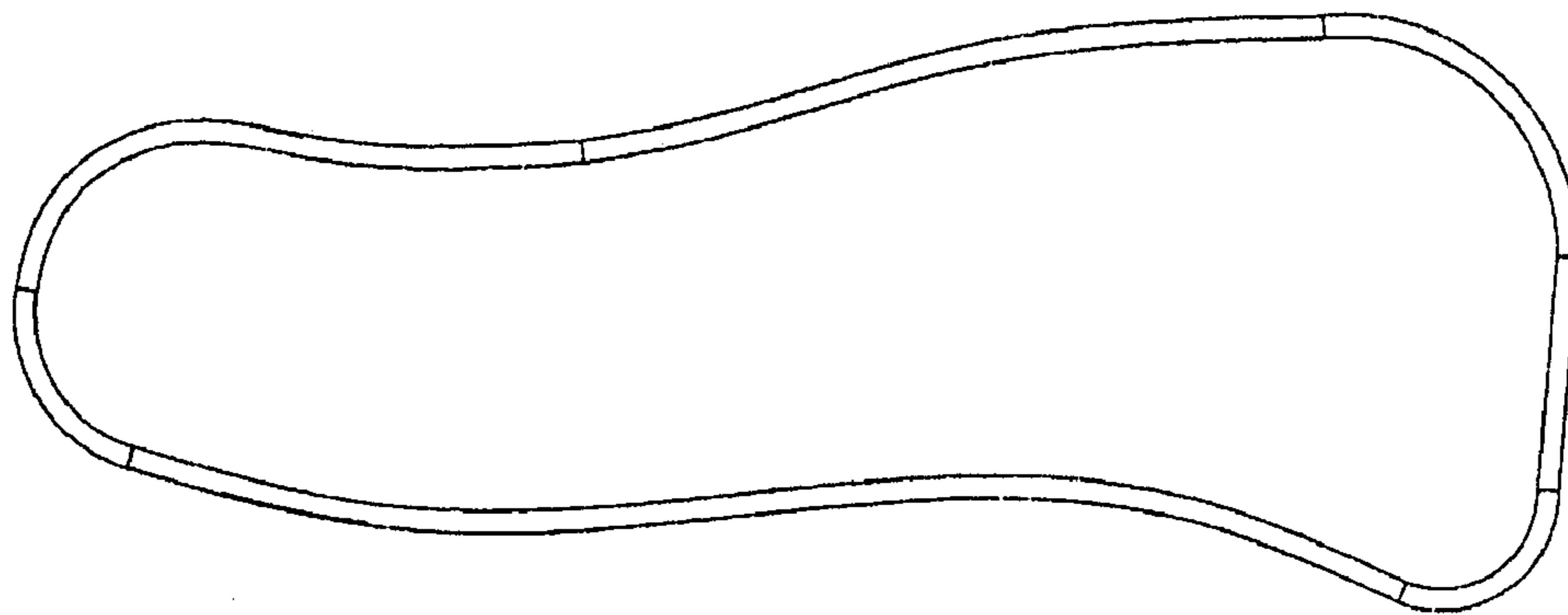

FIG. 5

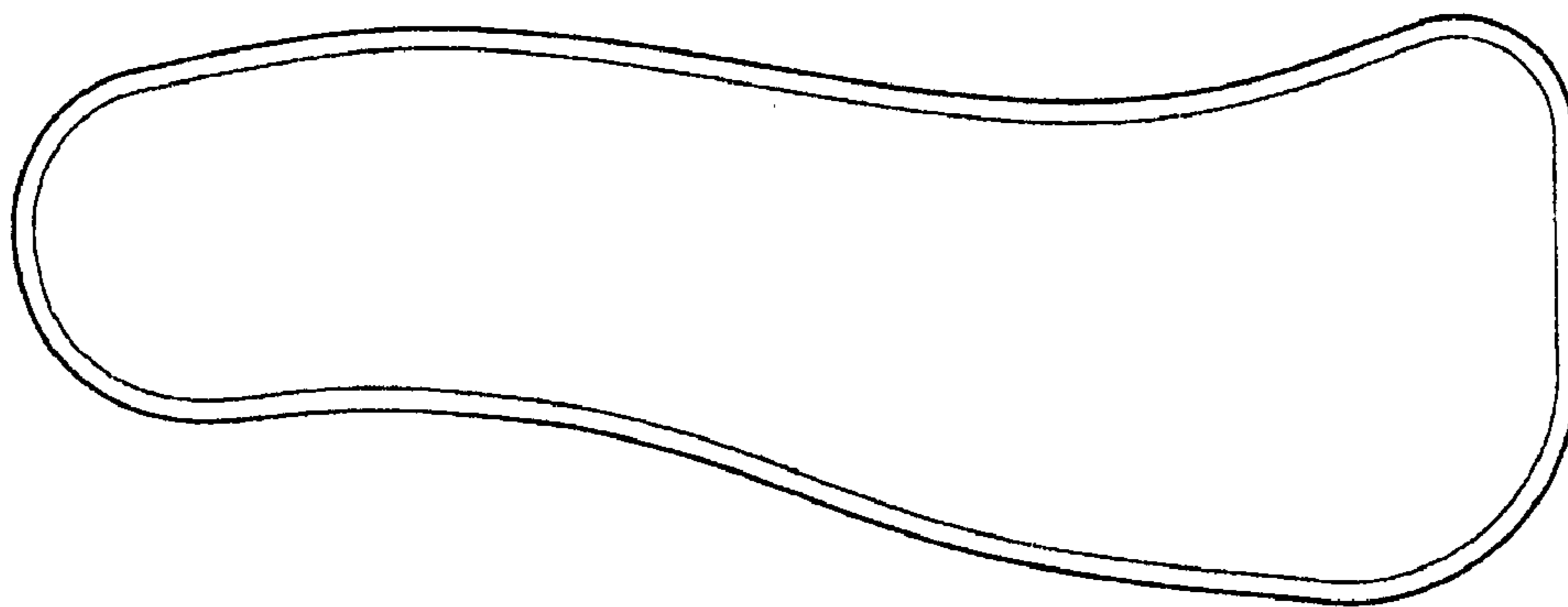

FIG. 6



FIG. 7

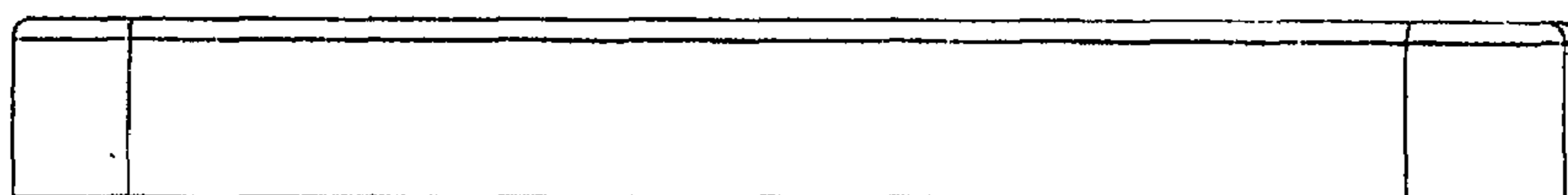

FIG. 8

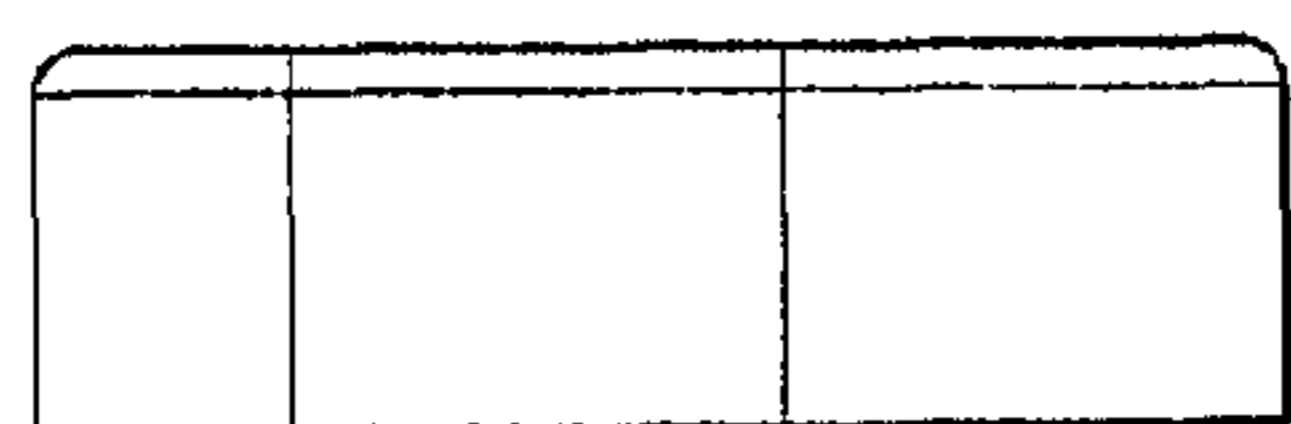

FIG. 9

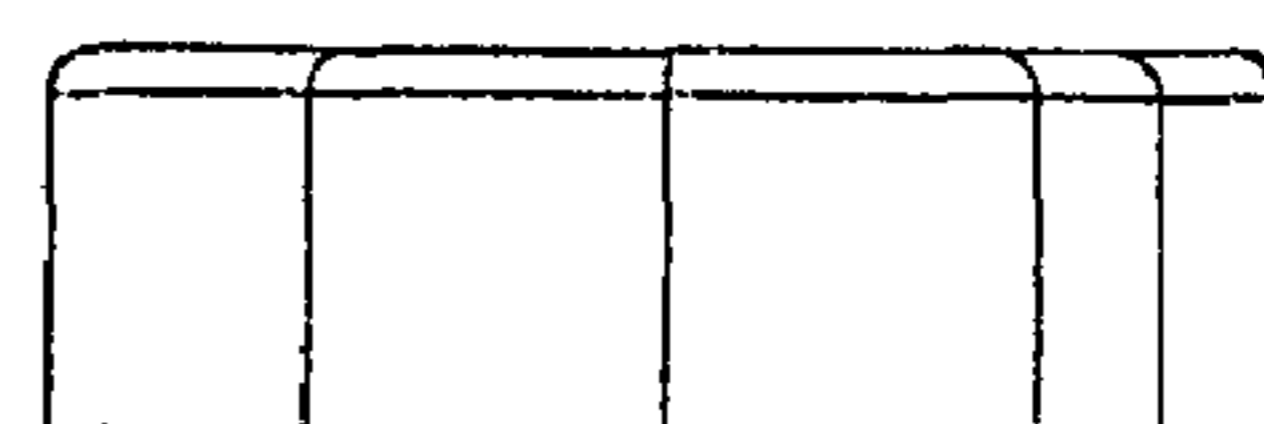

FIG. 10

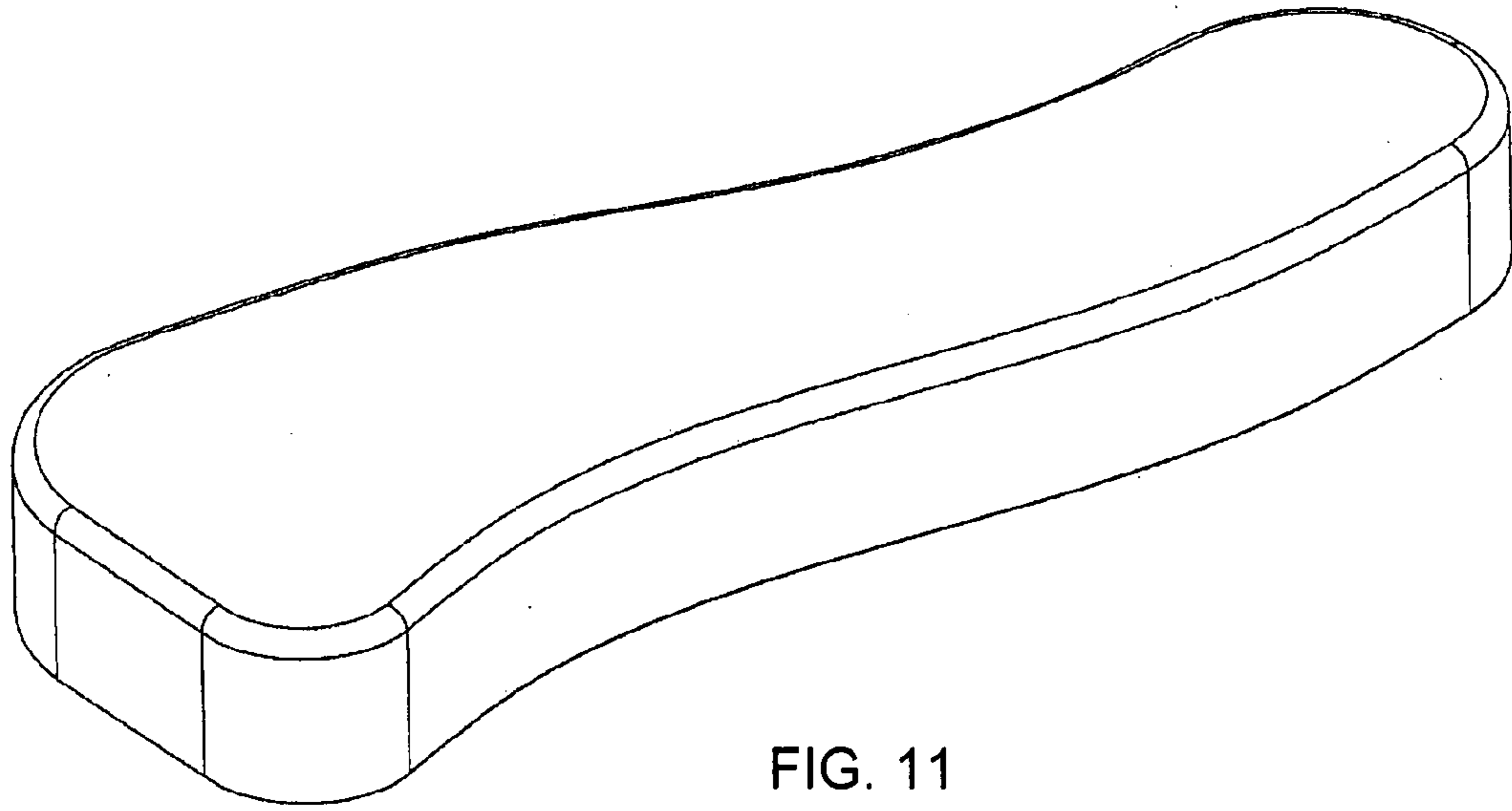

FIG. 11

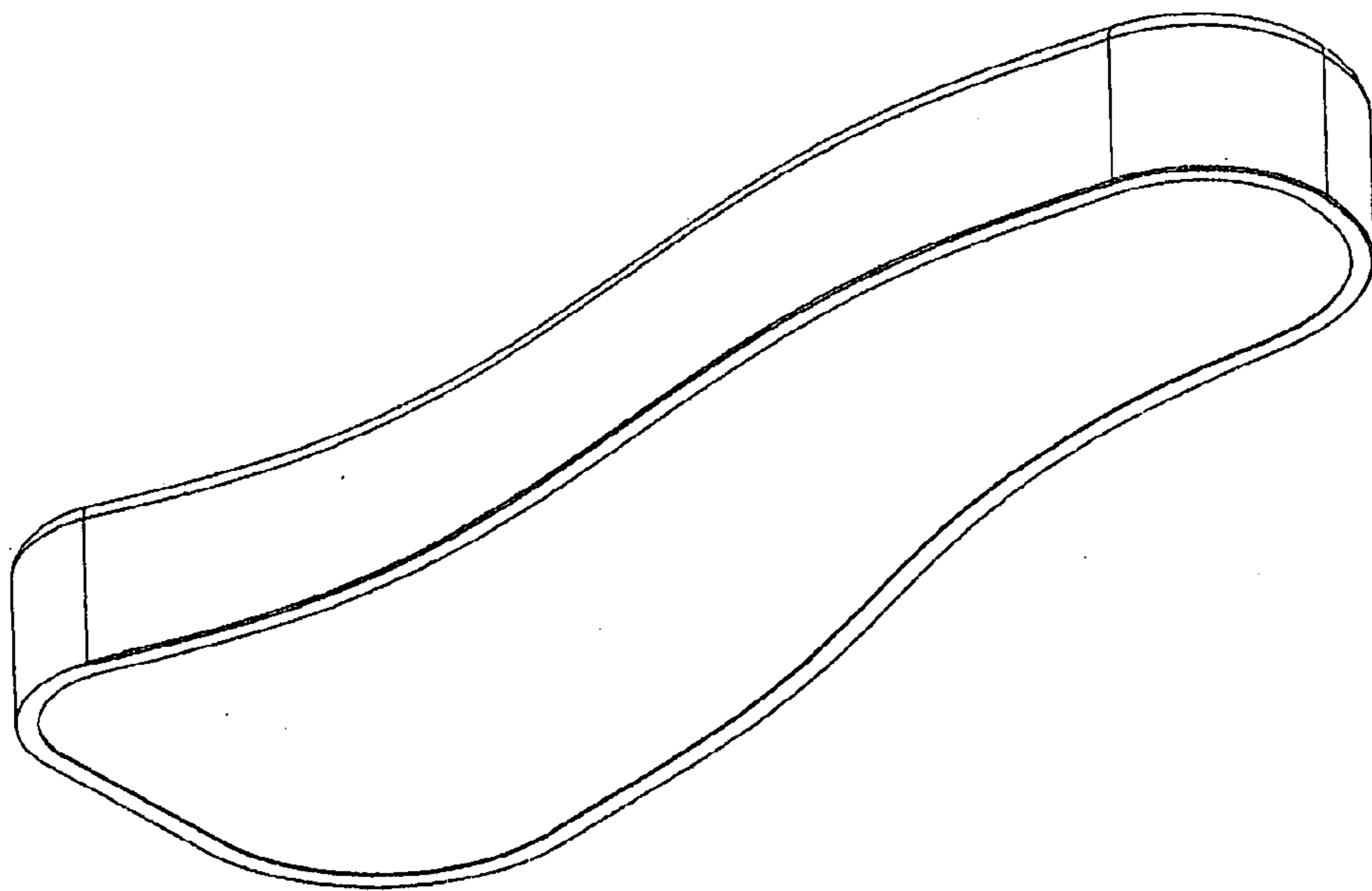

FIG. 12



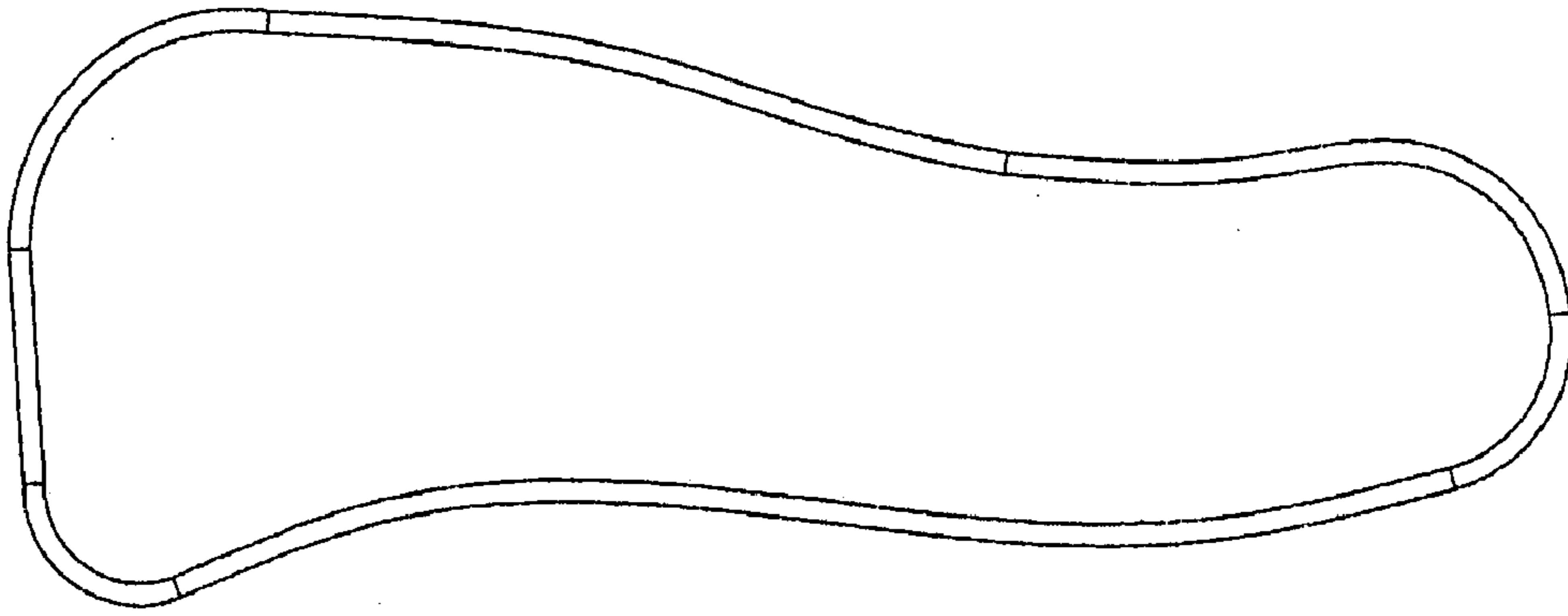

FIG. 13

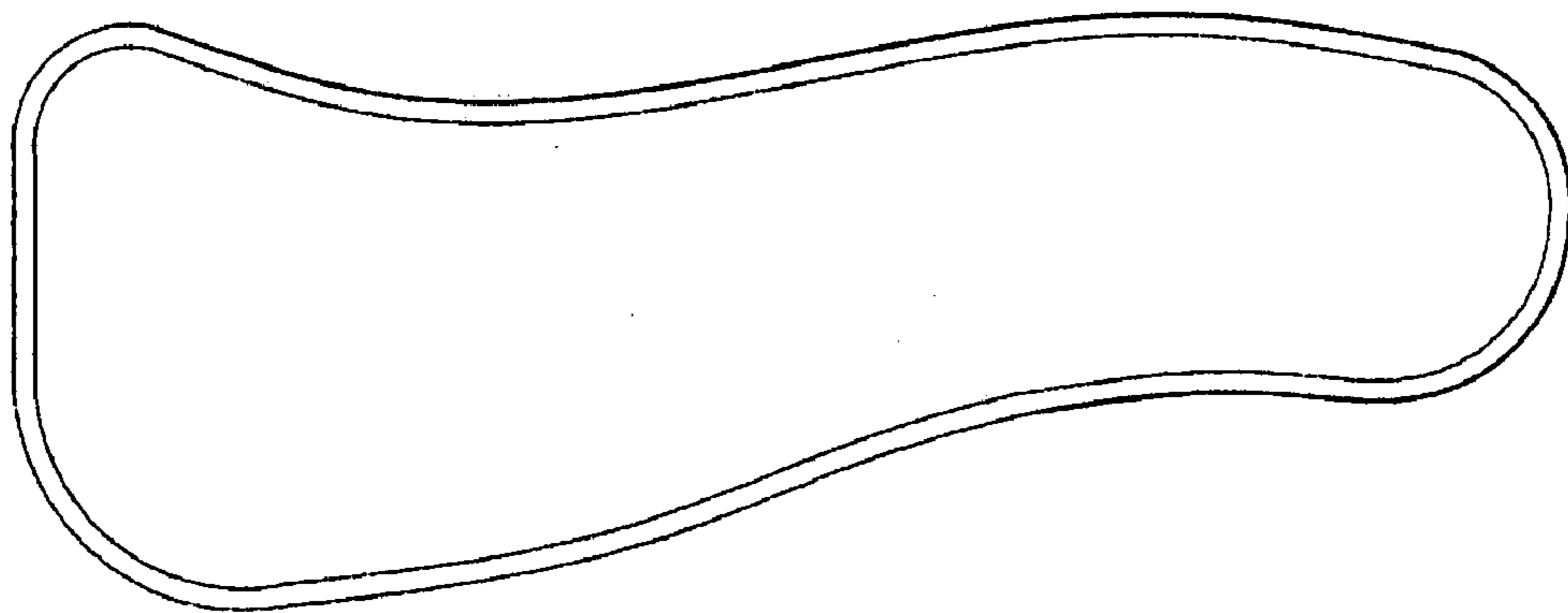

FIG. 14

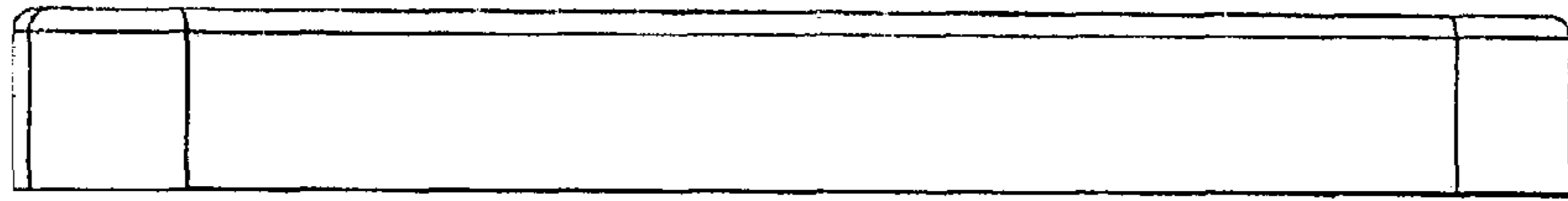

FIG. 15

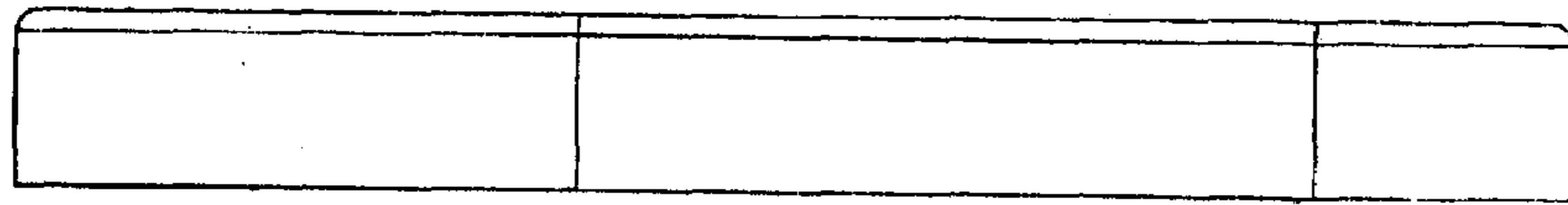

FIG. 16

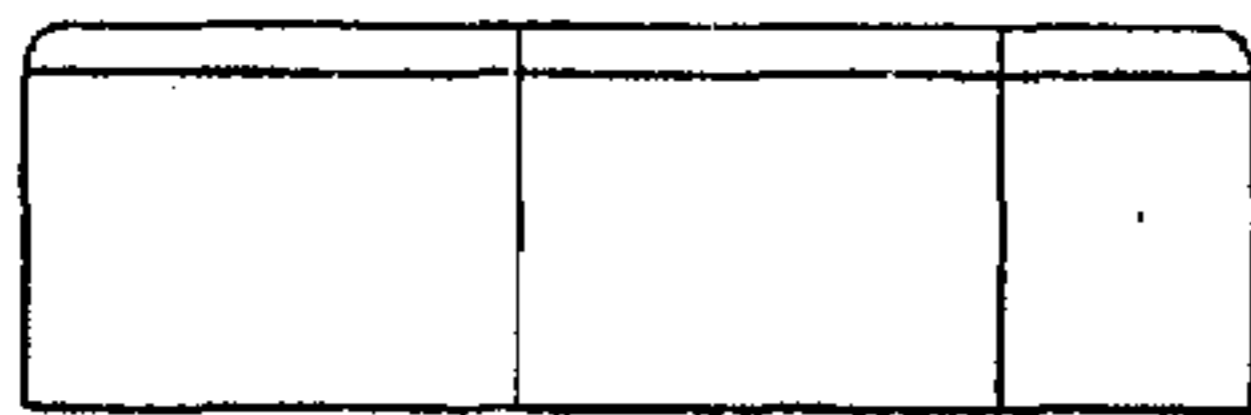

FIG. 17

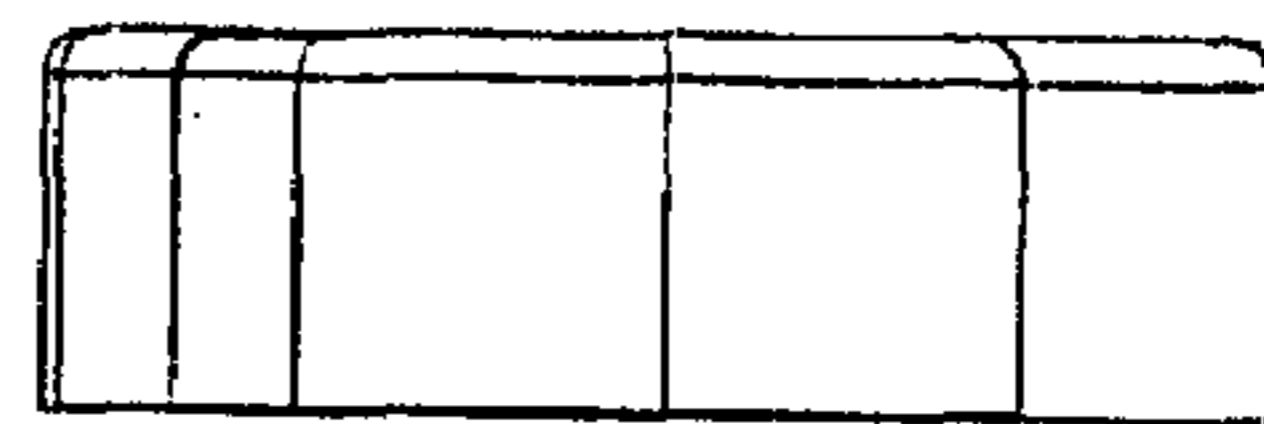

FIG. 18