



US00D555778S

(12) **United States Design Patent** (10) **Patent No.:** **US D555,778 S**
Fellows et al. (45) **Date of Patent:** **** Nov. 20, 2007**

(54) **5-CHAMBER AIR FRESHENER**
(75) Inventors: **Robert Fellows**, Park Ridge, NJ (US);
Jeffrey Lawrence Stern, Rancho Santa
Margarita, CA (US); **Kwok-Kuen Tong**,
Hong Kong (CN); **Steven Claisse**,
Tenafly, NJ (US); **Joseph Ponzoni**,
Washingtonville, NY (US); **Jose**
Michael Nina, Vernon, NJ (US)

(73) Assignees: **Waldwick Plastics Corporation**,
Waldwick, NJ (US); **Kerry, Inc.**, Beloit,
WI (US)

(**) Term: **14 Years**

(21) Appl. No.: **29/267,681**

(22) Filed: **Oct. 19, 2006**

(51) **LOC (8) Cl.** **28-99**
(52) **U.S. Cl.** **D23/366**
(58) **Field of Classification Search** 261/DIG. 17,
261/DIG. 42, DIG. 65, DIG. 88, DIG. 89;
D23/355-369; D28/5, 6; 392/341, 342,
392/386, 390, 392, 393, 394, 401; 239/34,
239/35, 42, 60, 53-58, 136, 326; D11/43,
D11/79

See application file for complete search history.

(56) **References Cited**

U.S. PATENT DOCUMENTS

168,972 A * 10/1875 Dayton 239/55
3,286,872 A * 11/1966 Burdick, Jr. 220/351
D227,011 S * 5/1973 Kovac D23/359
3,784,102 A * 1/1974 Stults 239/36
4,014,501 A * 3/1977 Buckenmayer 239/58
D268,520 S * 4/1983 LeCaire Jr. D23/369
D268,614 S * 4/1983 von Philipp et al. D23/369
4,382,548 A * 5/1983 van der Heijden 239/56
D296,820 S * 7/1988 Suhajda D23/363
4,815,659 A * 3/1989 Turko et al. 239/6
D323,383 S * 1/1992 Keays et al. D23/366

D367,924 S * 3/1996 Patel et al. D23/369
D375,350 S * 11/1996 Patel et al. D23/369
D399,945 S * 10/1998 Bonomo et al. D23/369
D436,536 S * 1/2001 Levi D9/447
D441,441 S * 5/2001 Upson D23/366
6,244,518 B1 * 6/2001 Pogue 239/36
6,631,852 B1 * 10/2003 O'Leary 239/60
D487,308 S * 3/2004 Engerant D23/366
D490,886 S * 6/2004 Engerant D23/366
D493,515 S * 7/2004 Morillas D23/366
D493,878 S * 8/2004 Morillas D23/366
D494,668 S * 8/2004 Morillas D23/366
D495,044 S * 8/2004 Morillas D23/366
D497,424 S * 10/2004 Morillas D23/366
D497,665 S * 10/2004 Morillas D23/366
D497,986 S * 11/2004 Morillas D23/366
D498,524 S * 11/2004 Morillas D23/366
D498,836 S * 11/2004 Morillas D23/366
D503,974 S * 4/2005 Morillas D23/366
D504,500 S * 4/2005 Morillas D23/366

* cited by examiner

Primary Examiner—Sandra Snapp

(57) **CLAIM**

The ornamental design for a 5-chamber air freshener, as shown and described.

DESCRIPTION

FIG. 1 is a perspective front view of the 5-chamber air freshener showing our new design;
FIG. 2 is a front view thereof;
FIG. 3 is a rear view thereof;
FIG. 4 is a side view thereof;
FIG. 5 is a opposite side view thereof;
FIG. 6 is a top view thereof; and,
FIG. 7 is a bottom view thereof.

The broken lines shown in the drawings are for illustrative purposes only and form no part of the claimed design.

1 Claim, 3 Drawing Sheets

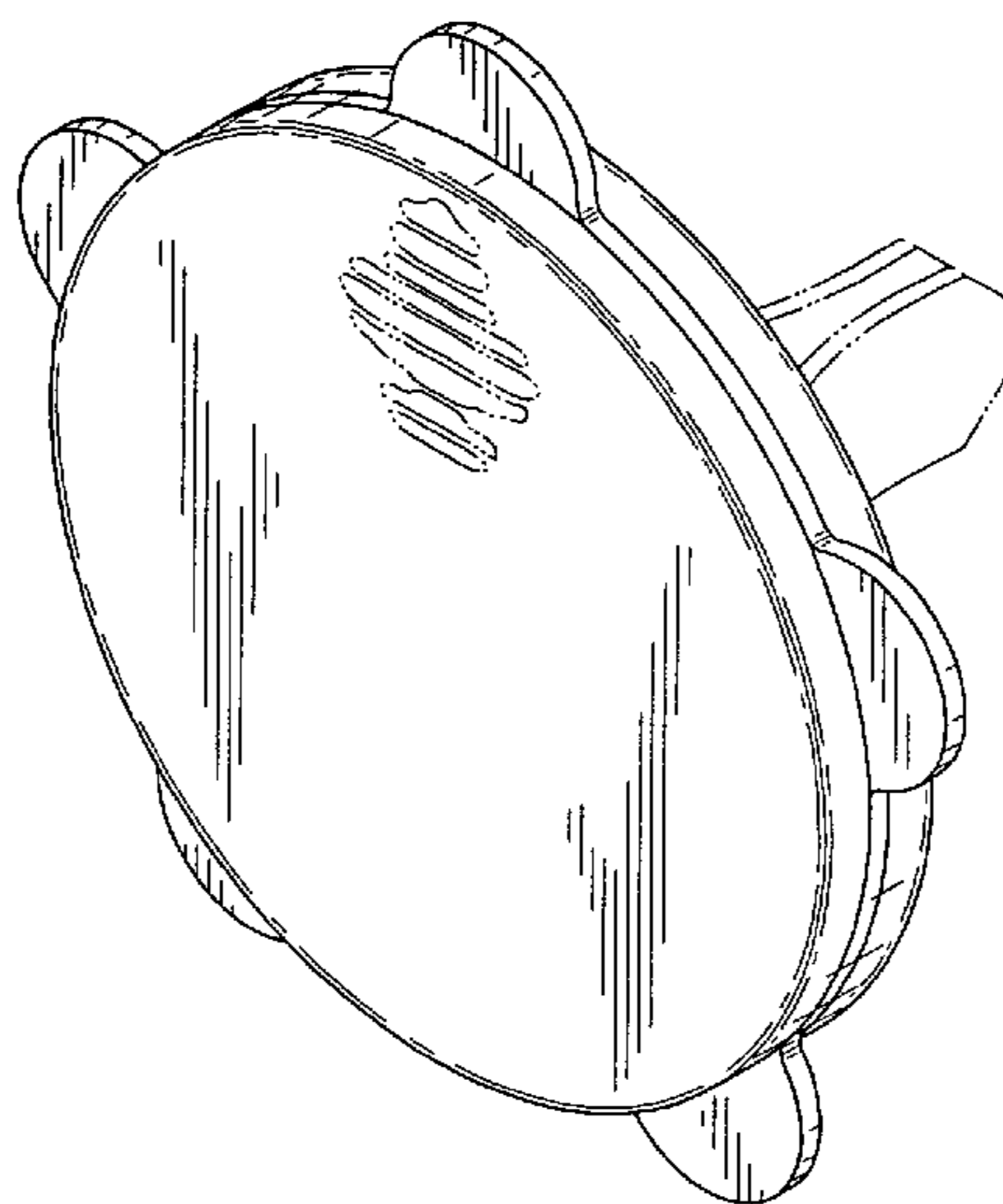

FIG. 1

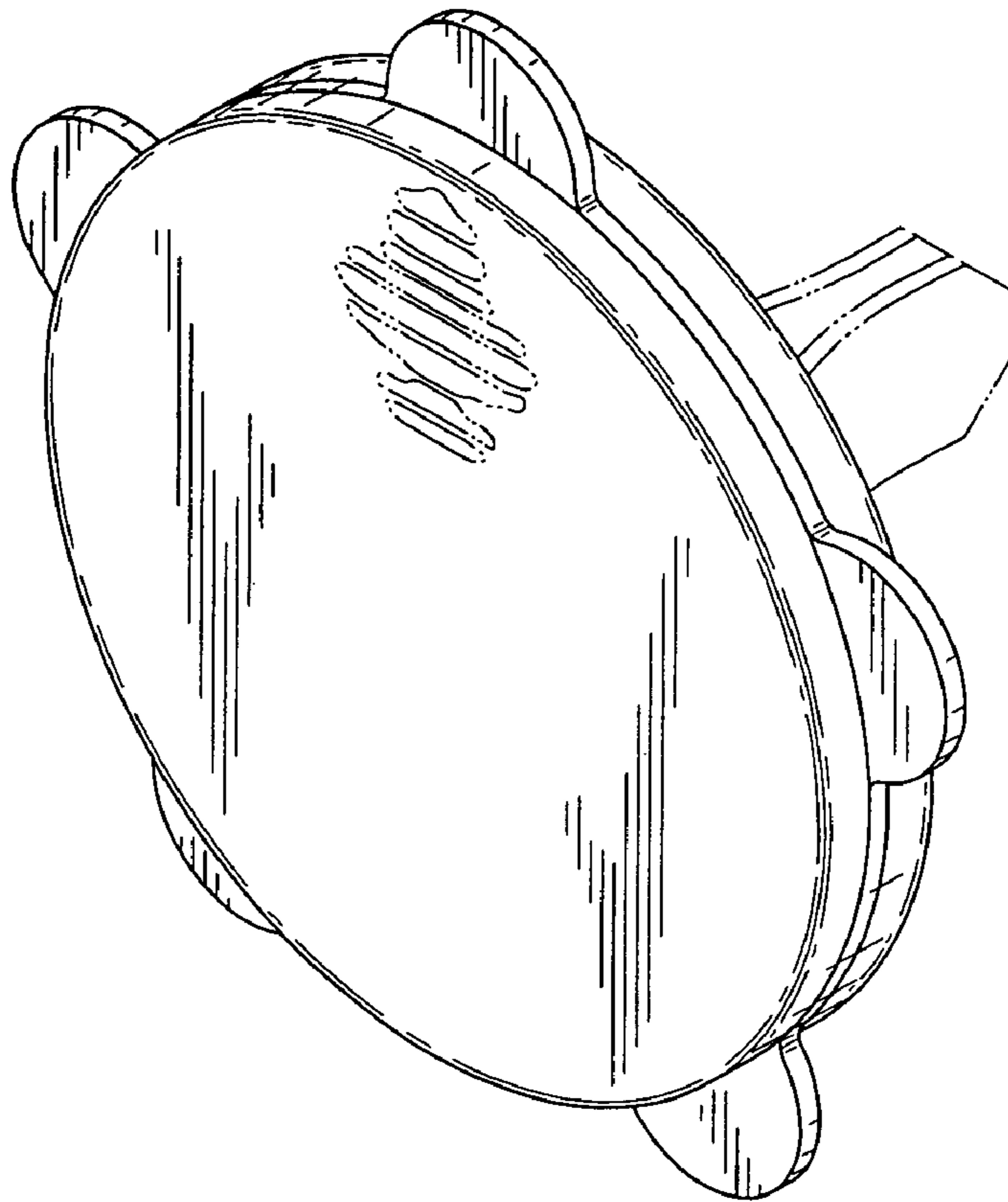

FIG. 2

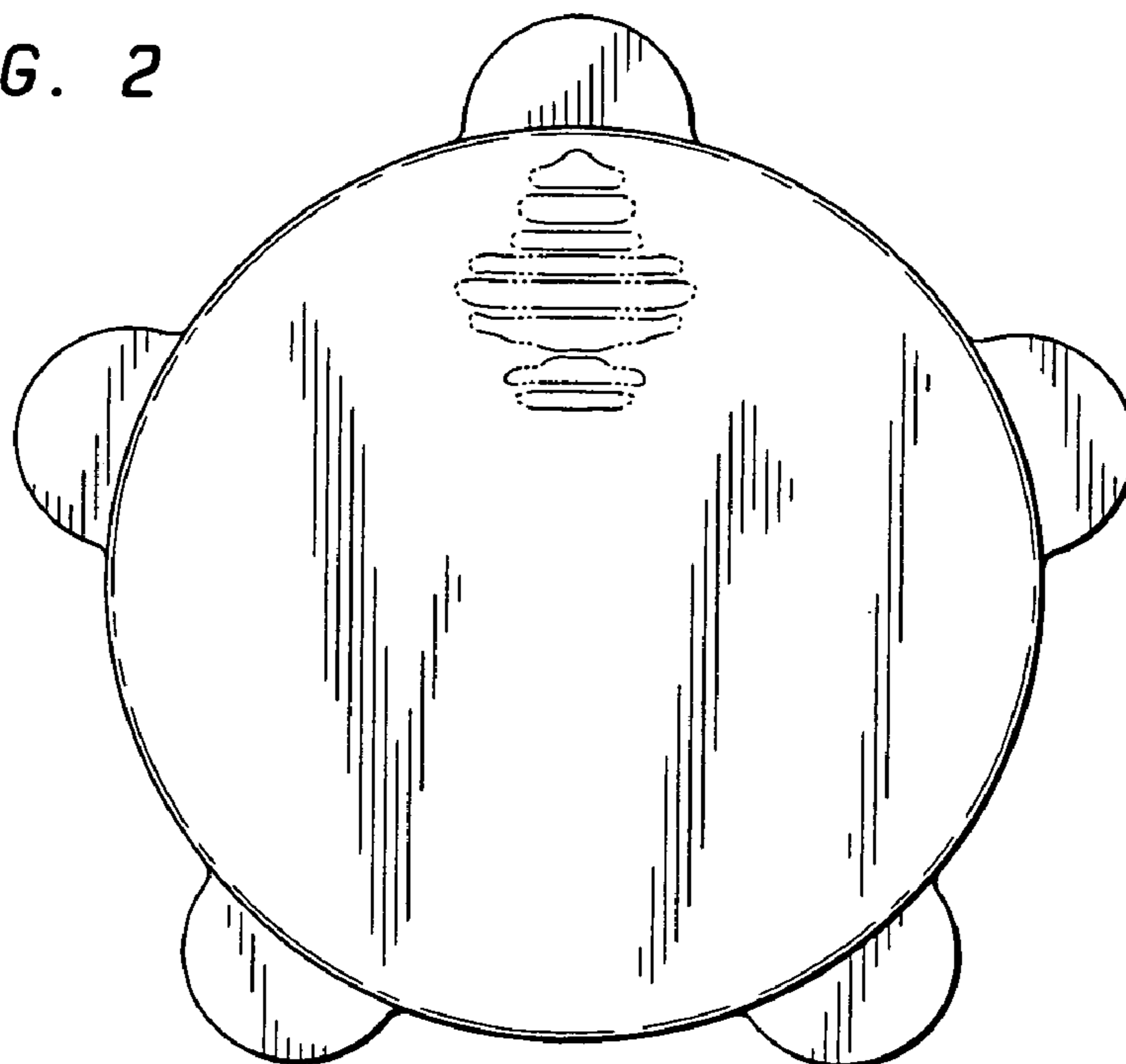

FIG. 3

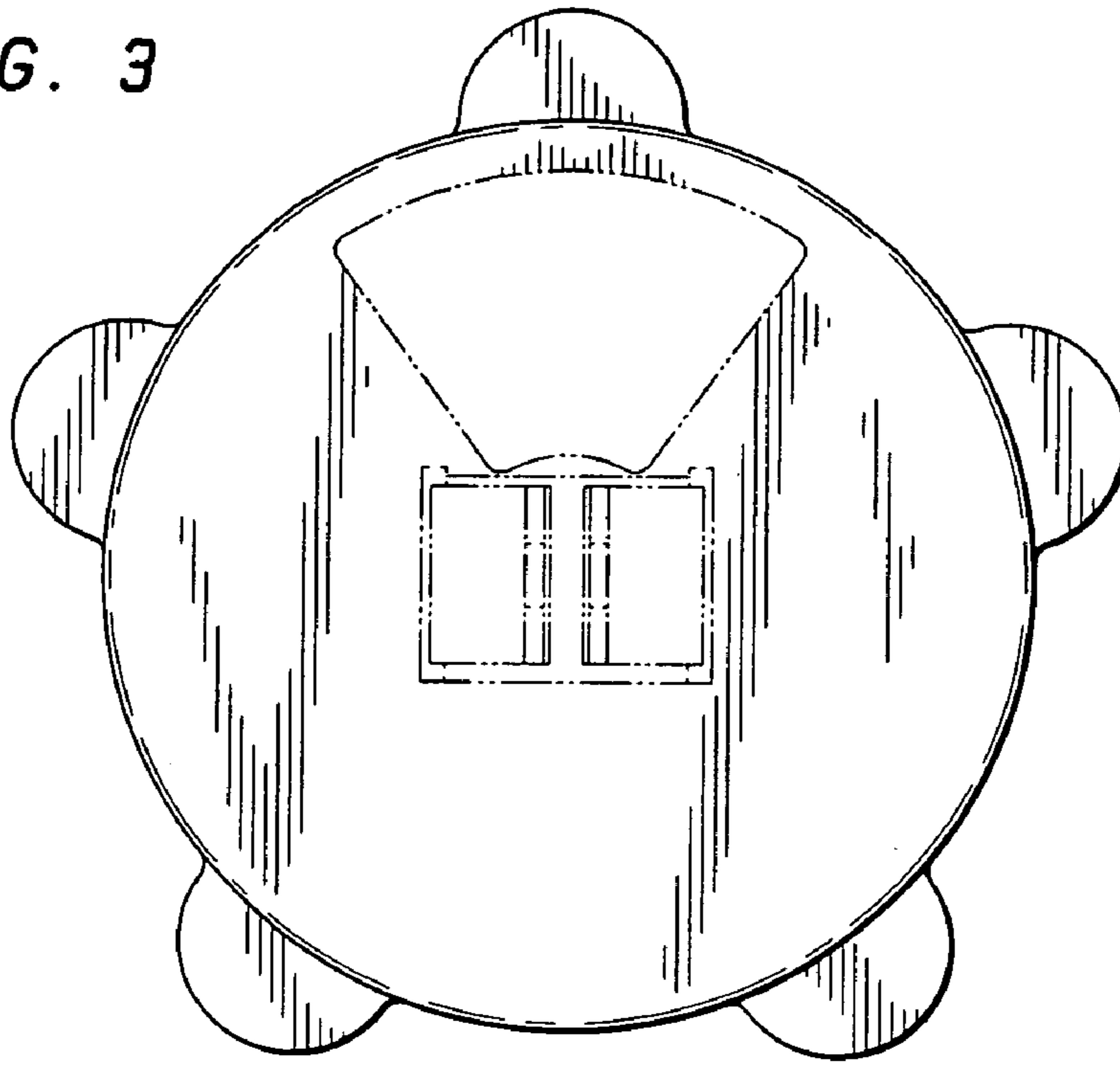

FIG. 4

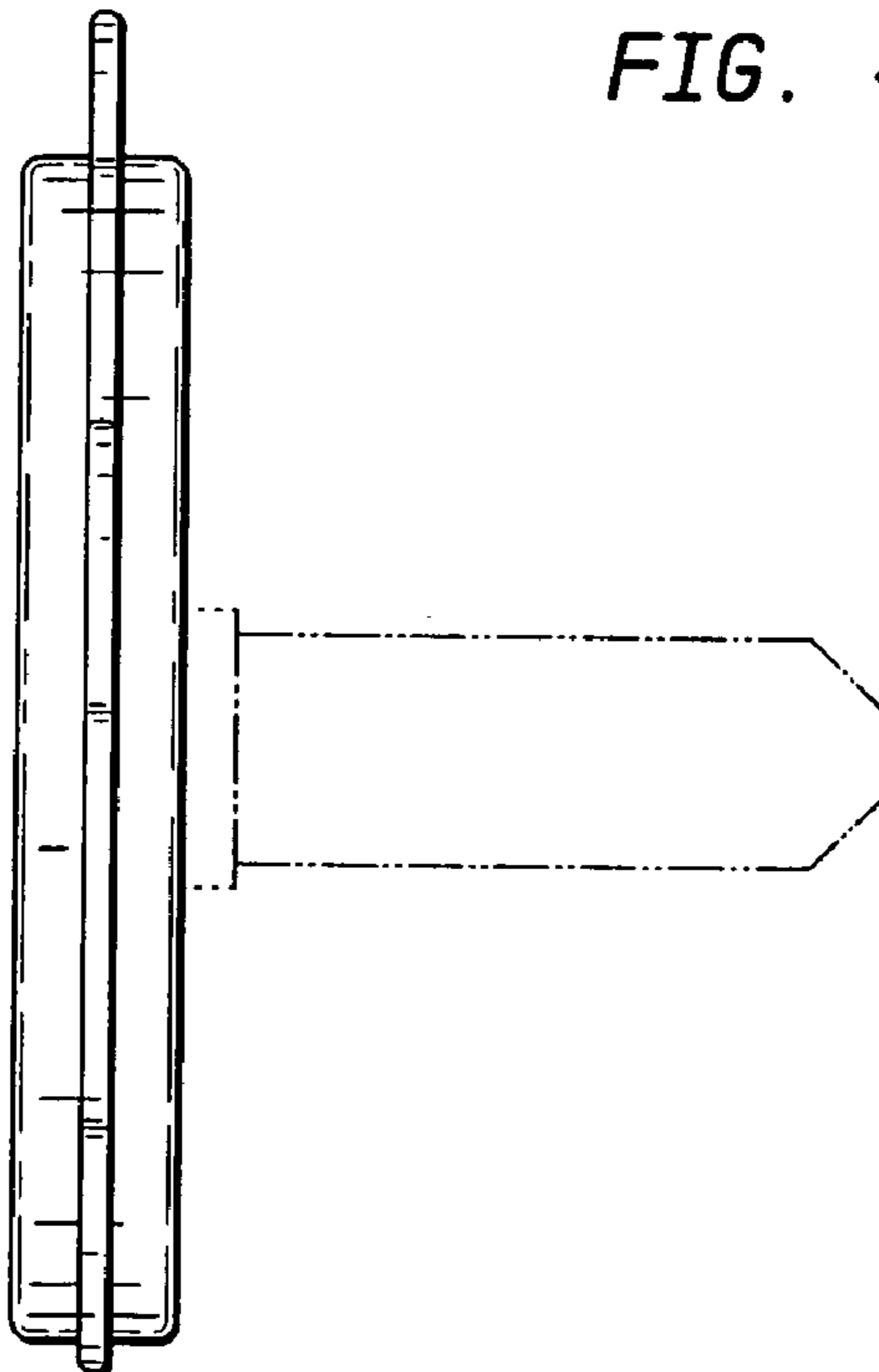

FIG. 5

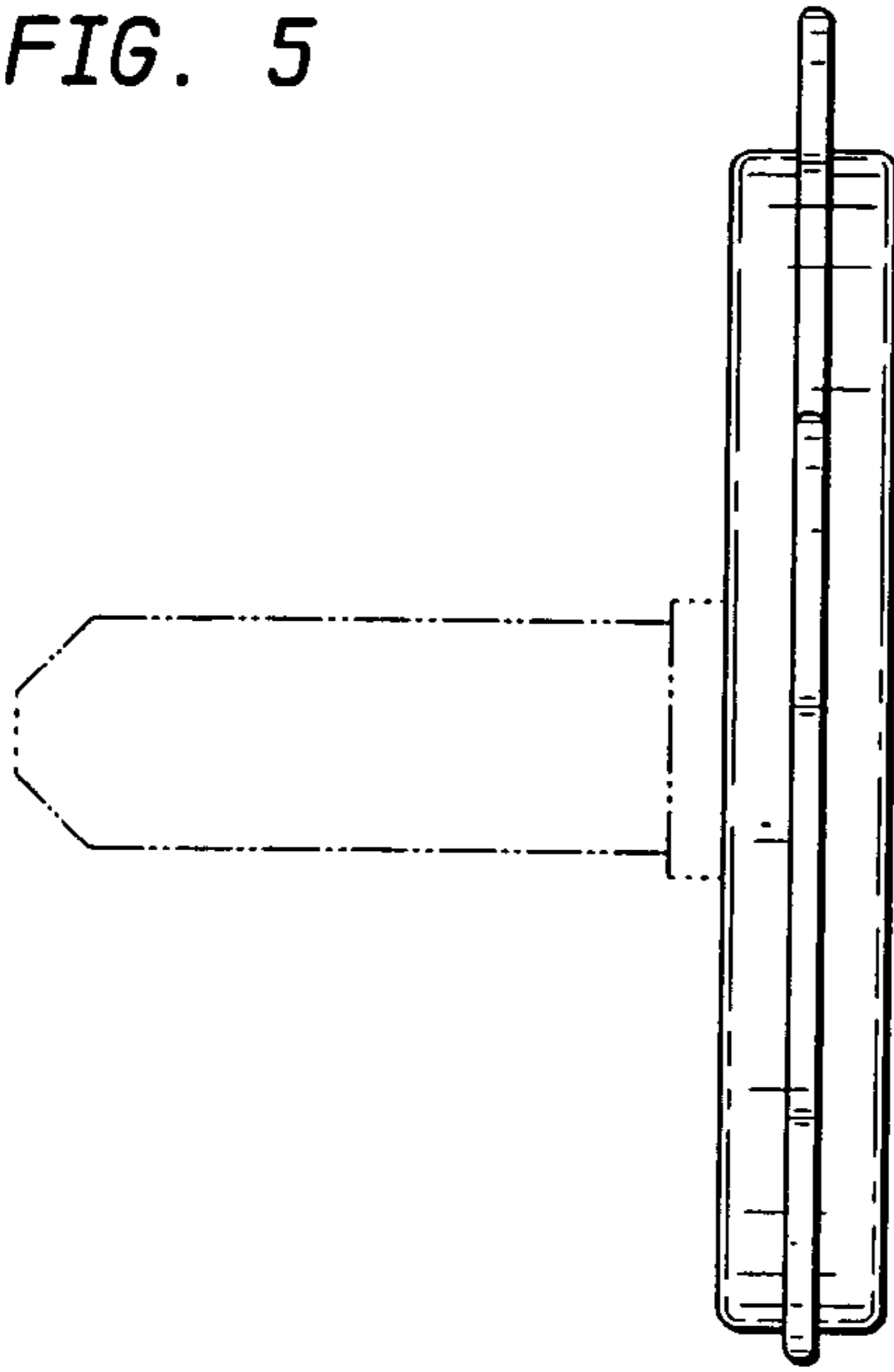

FIG. 6

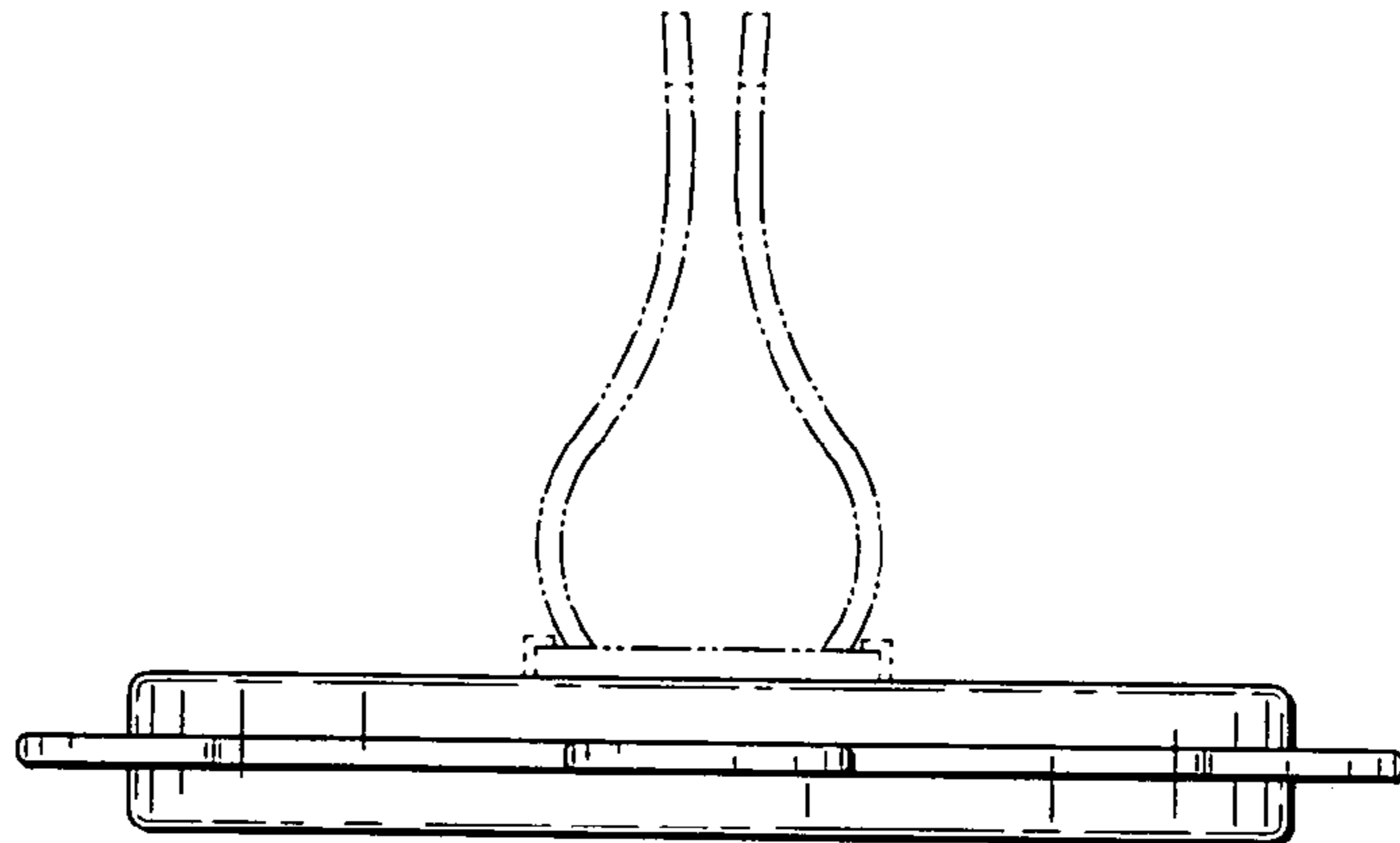

FIG. 7

