



US00D555746S

(12) **United States Design Patent**  
**Hauskins**

(10) **Patent No.:** **US D555,746 S**

(45) **Date of Patent:** **\*\* Nov. 20, 2007**

(54) **GOLF TEE LOCATOR**

(76) Inventor: **Lawrence T. Hauskins**, 17783  
Ketchikan Ct., Lakeville, MN (US)  
55044

(\*\*) Term: **14 Years**

(21) Appl. No.: **29/262,630**

(22) Filed: **Jul. 10, 2006**

(51) **LOC (8) Cl.** ..... **21-02**

(52) **U.S. Cl.** ..... **D21/789**

(58) **Field of Classification Search** ..... D21/789,  
D21/796, 793, 717-718; 206/315.1; 473/284,  
473/257, 386-403

See application file for complete search history.

(56) **References Cited**

U.S. PATENT DOCUMENTS

2,165,479 A *	7/1939	Hallberg	.....	473/257
D176,875 S *	2/1956	Miller	.....	D21/718
D399,896 S *	10/1998	Plain	.....	D21/717
D418,570 S *	1/2000	Malinoff	.....	D21/789
D539,374 S *	3/2007	Whitehouse	.....	D21/789

\* cited by examiner

*Primary Examiner*—Mitchell Siegel

(74) *Attorney, Agent, or Firm*—Richard J. Bratz

(57) **CLAIM**

The ornamental design of a golf tee locator, as shown and described.

**DESCRIPTION**

FIG. 1 is a perspective view of the golf tee locator of my design;

FIG. 2 is a front elevational view thereof;

FIG. 3 is a side elevational view thereof, the opposite side elevational view being a mirror image thereof;

FIG. 4 is a rear elevational view thereof;

FIG. 5 is a top plan view thereof;

FIG. 6 is a bottom plan view thereof;

FIG. 7 is a perspective view of a first modification of the golf tee locator of FIG. 1;

FIG. 8 is a front elevational view of FIG. 7;

FIG. 9 is a side elevational view of FIG. 7, the opposite side elevational view being a mirror image thereof;

FIG. 10 is a rear elevational view of FIG. 7;

FIG. 11 is a top plan view of FIG. 7;

FIG. 12 is a bottom plan view of FIG. 7;

FIG. 13 is a perspective view of a second modification of the golf tee locator of FIG. 1;

FIG. 14 is a front elevational view of FIG. 13;

FIG. 15 is a side elevational view of FIG. 13, the opposite side elevational view being a mirror image thereof;

FIG. 16 is a rear elevational view of FIG. 13;

FIG. 17 is a top plan view of FIG. 13;

FIG. 18 is a bottom plan view of FIG. 13;

FIG. 19 is a perspective view of a third modification of the golf tee locator of FIG. 1;

FIG. 20 is a front elevational view of FIG. 19;

FIG. 21 is a side elevational view of FIG. 19, the opposite side being a mirror image thereof;

FIG. 22 is a rear elevational view of FIG. 19;

FIG. 23 is a top plan view of FIG. 19; and,

FIG. 24 is a bottom plan view of FIG. 19.

**1 Claim, 4 Drawing Sheets**

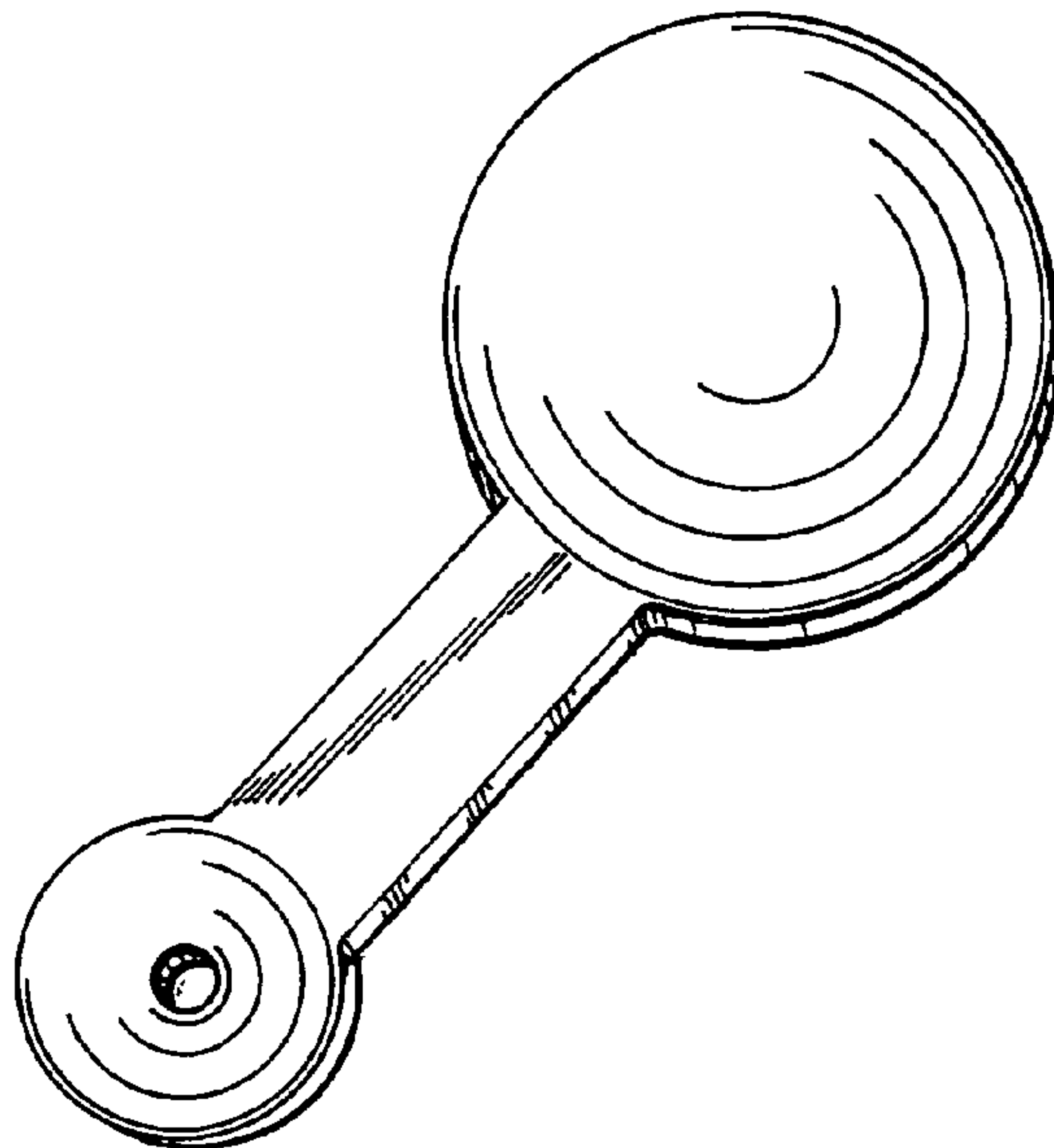

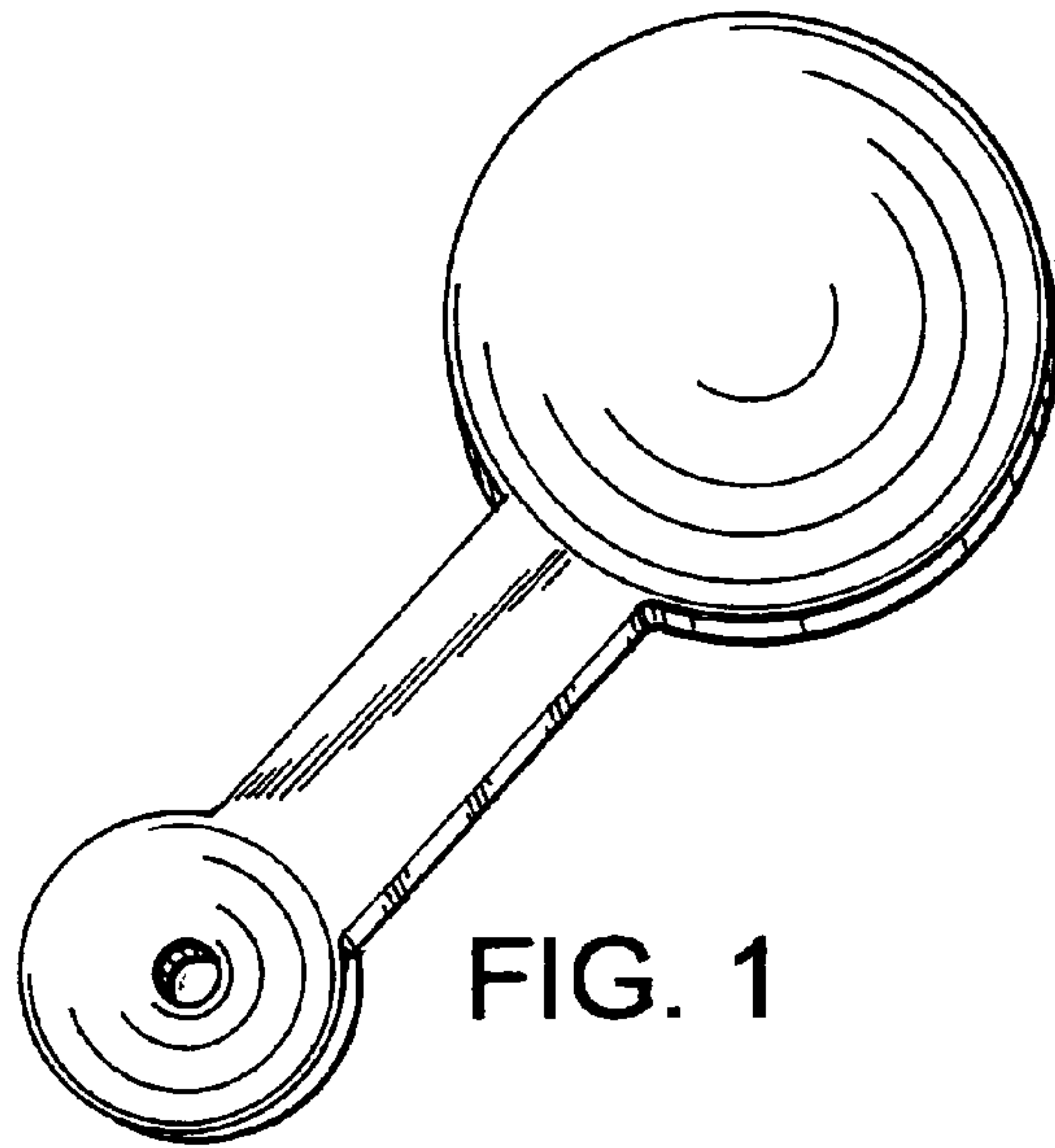

FIG. 1

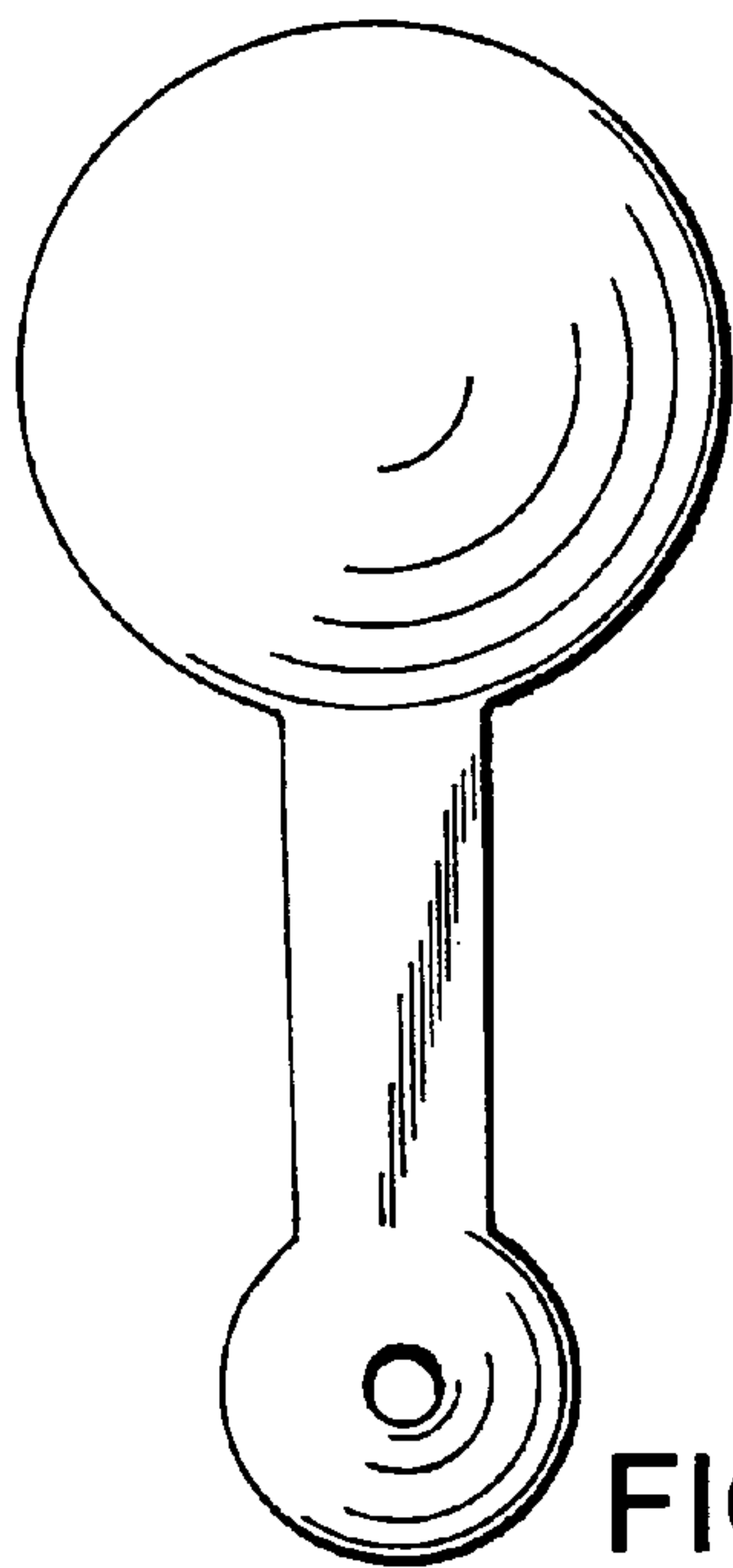

FIG. 2



FIG. 3

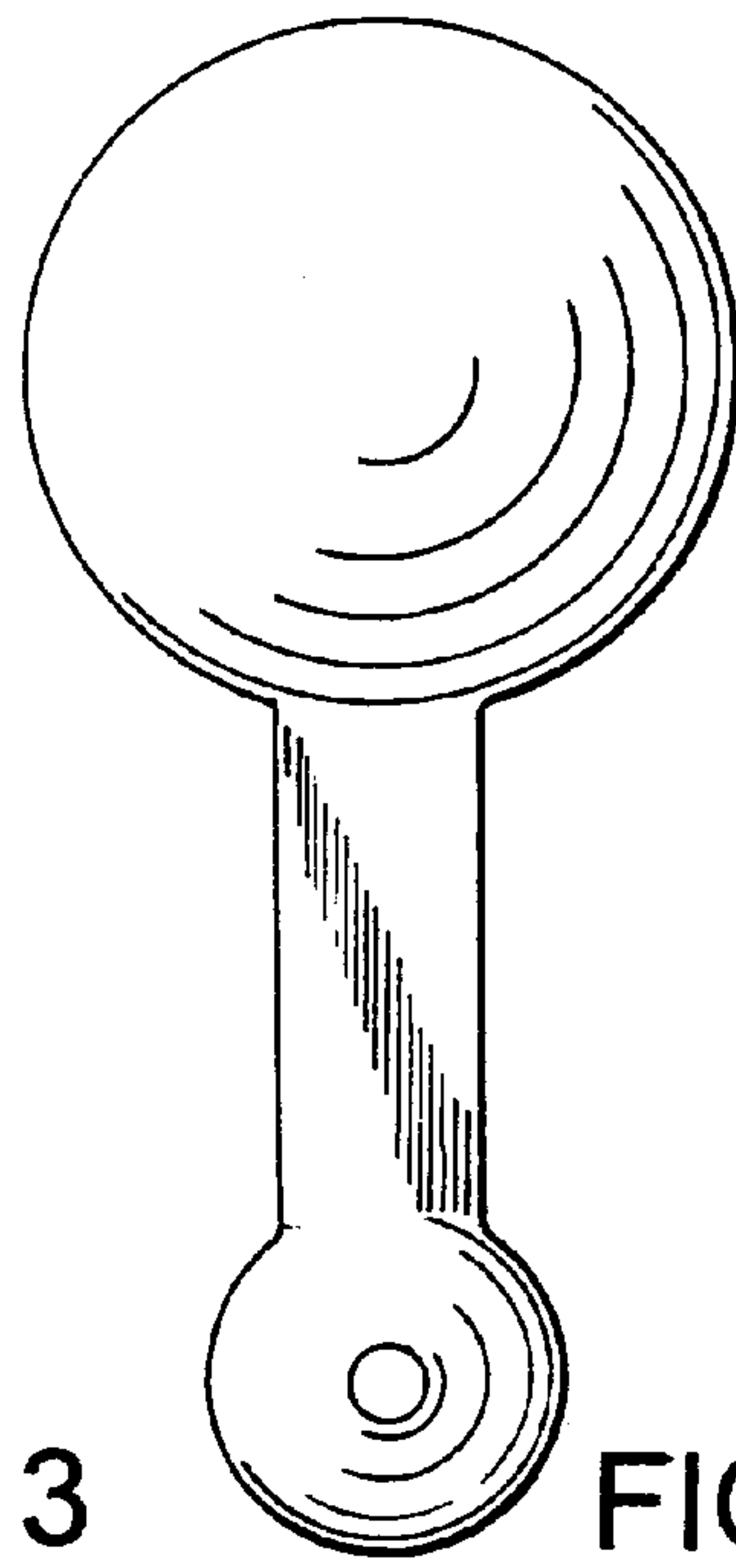

FIG. 4



FIG. 5



FIG. 6

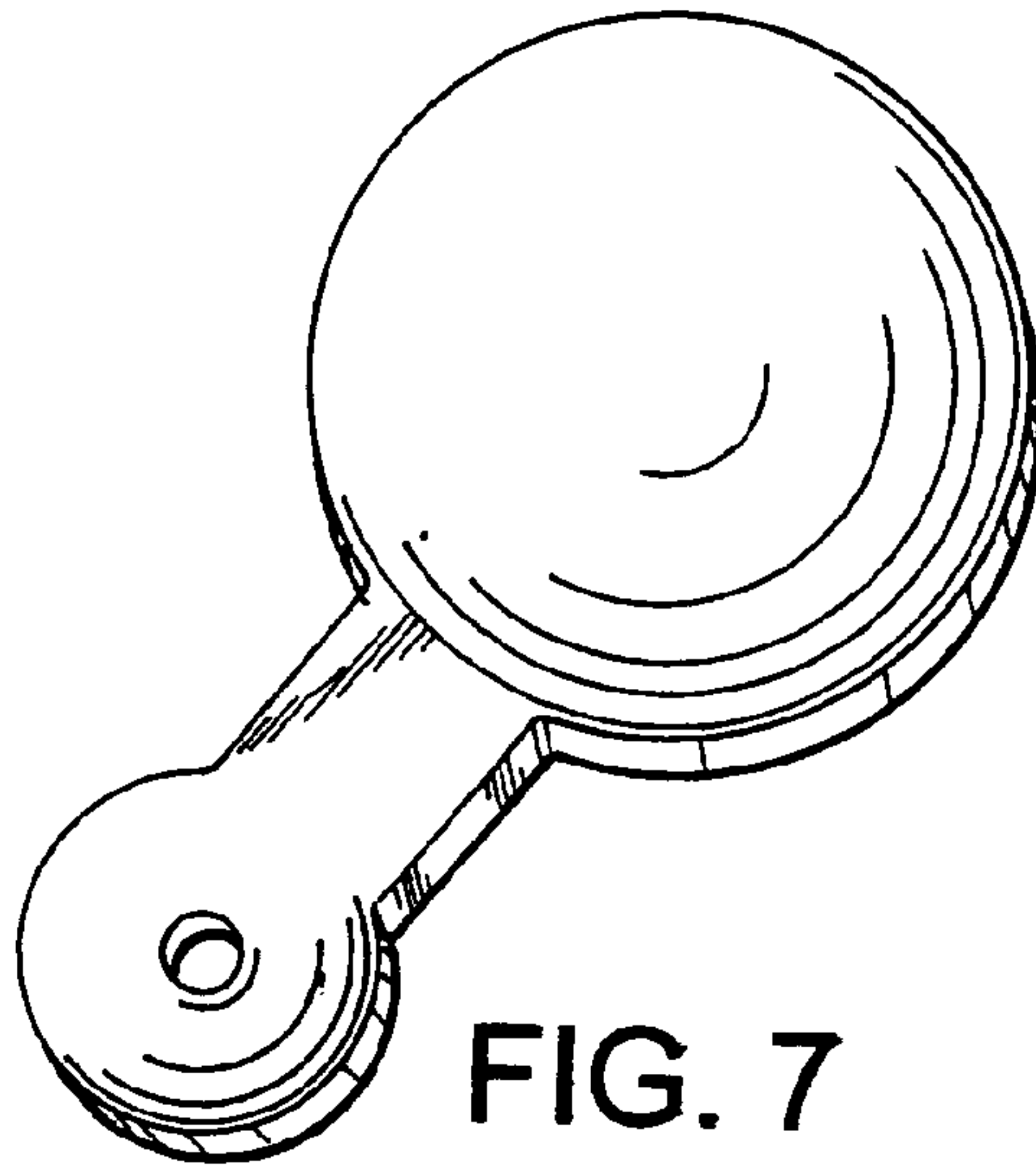

FIG. 7

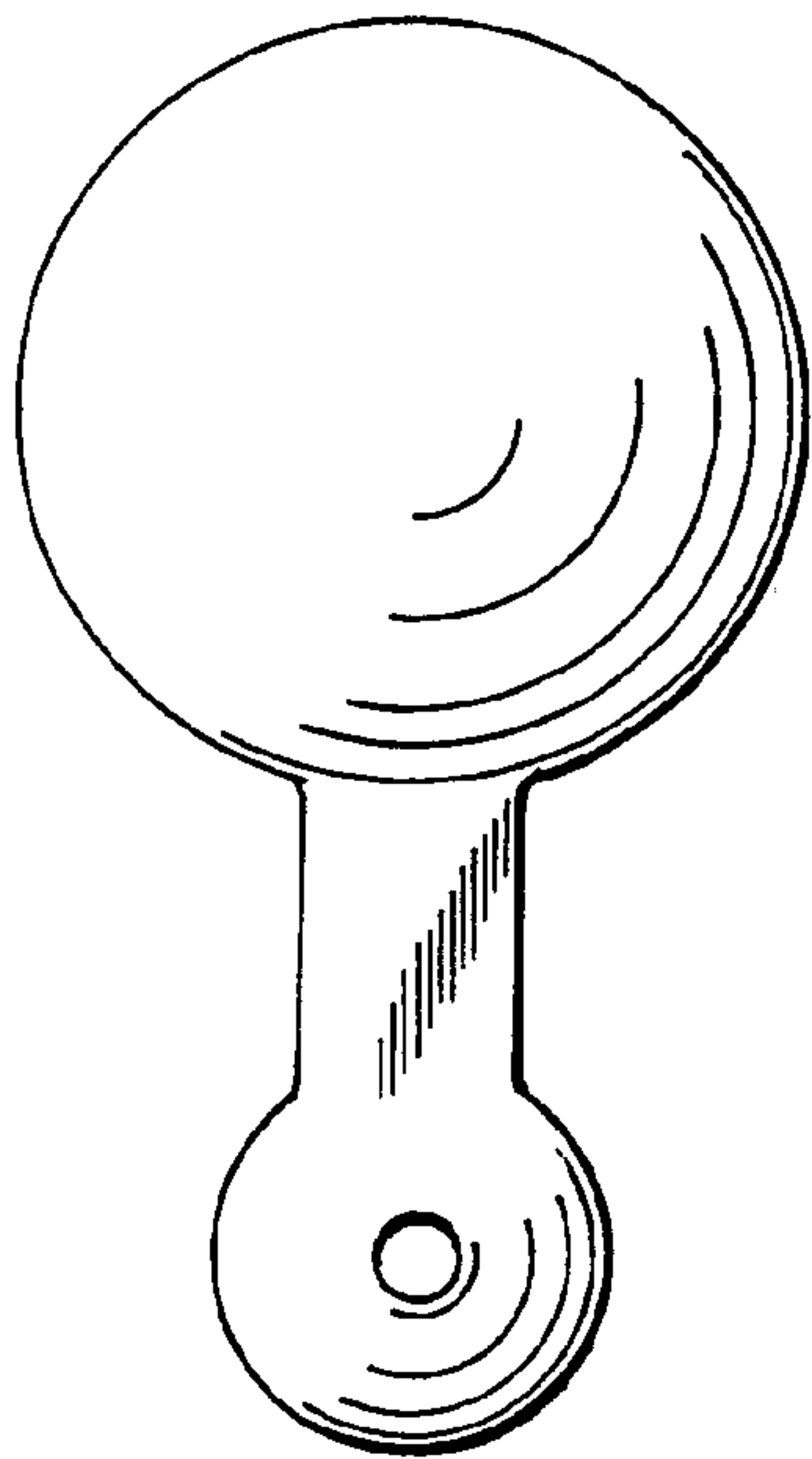

FIG. 8



FIG. 9

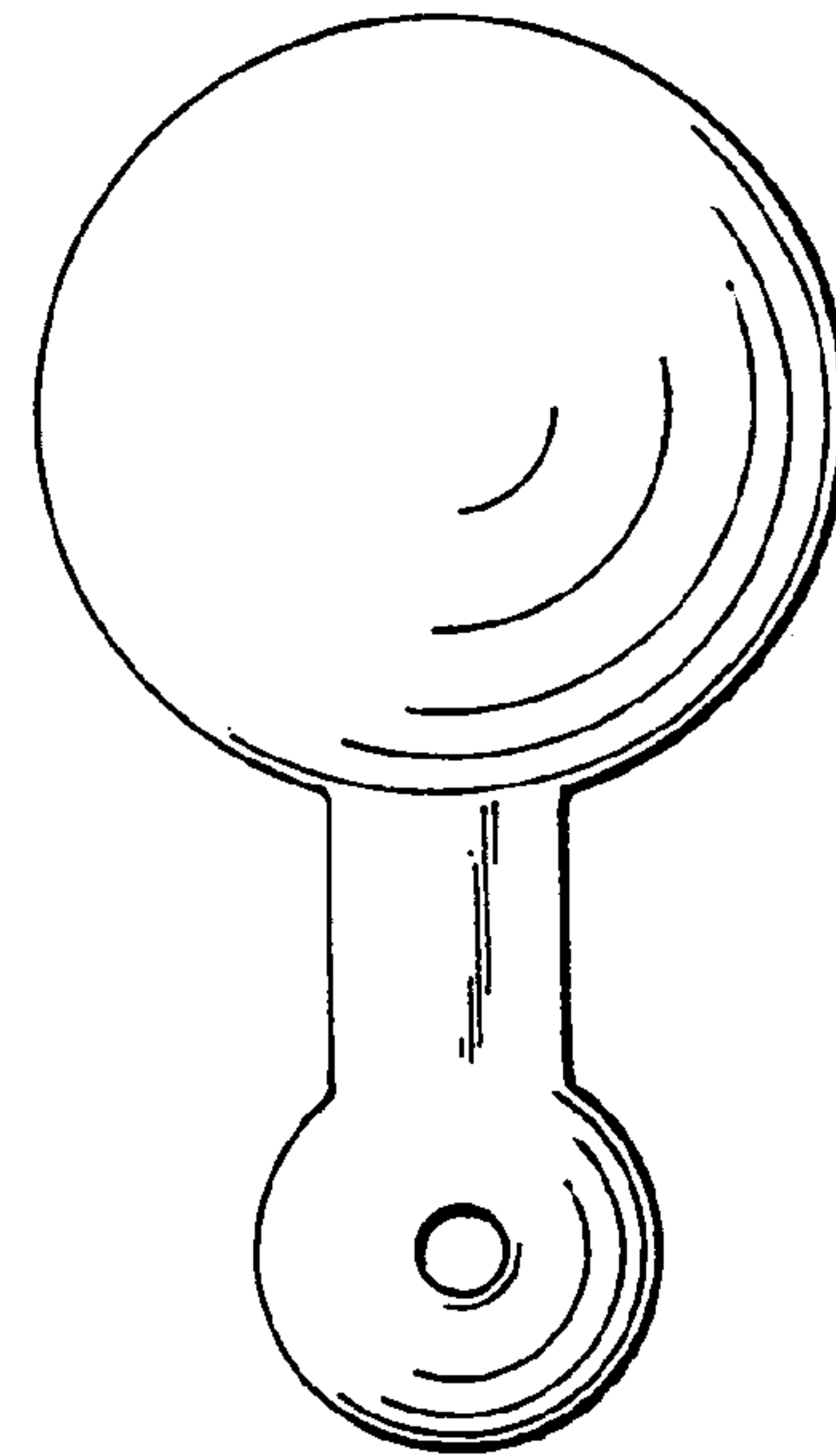

FIG. 10

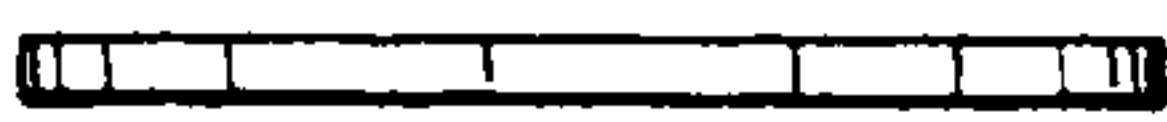

FIG. 11

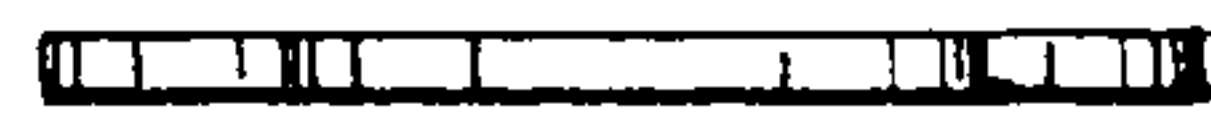

FIG. 12

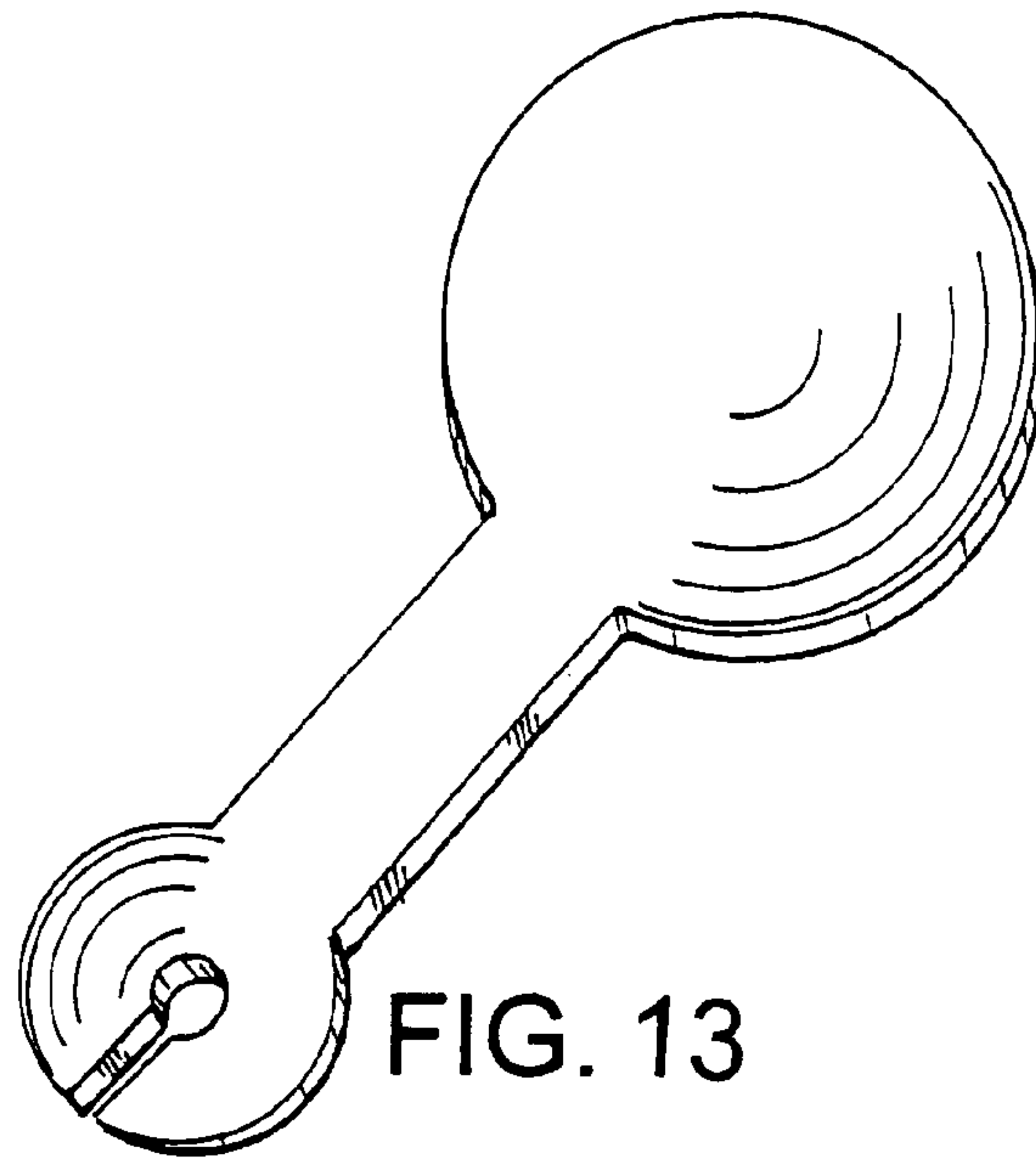

FIG. 13

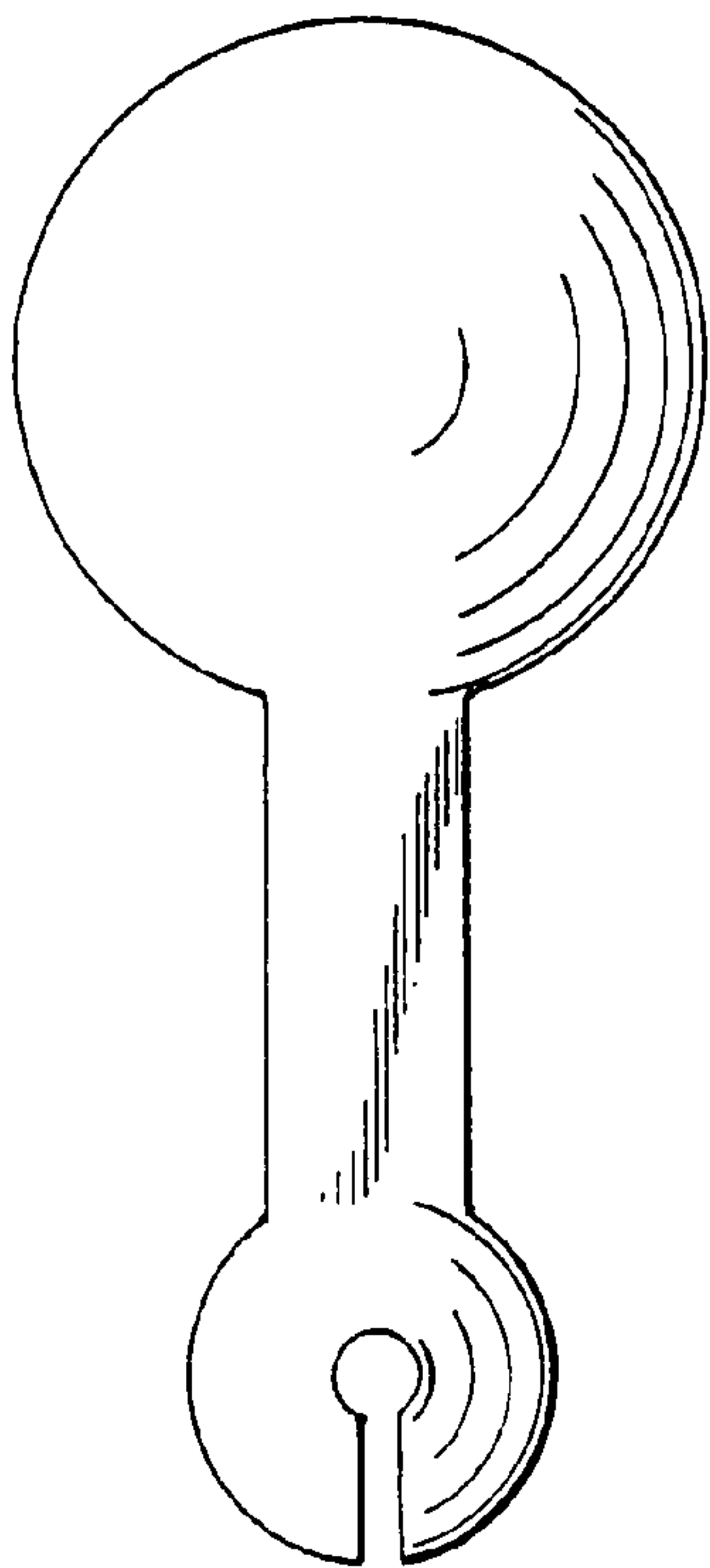

FIG. 14



FIG. 15

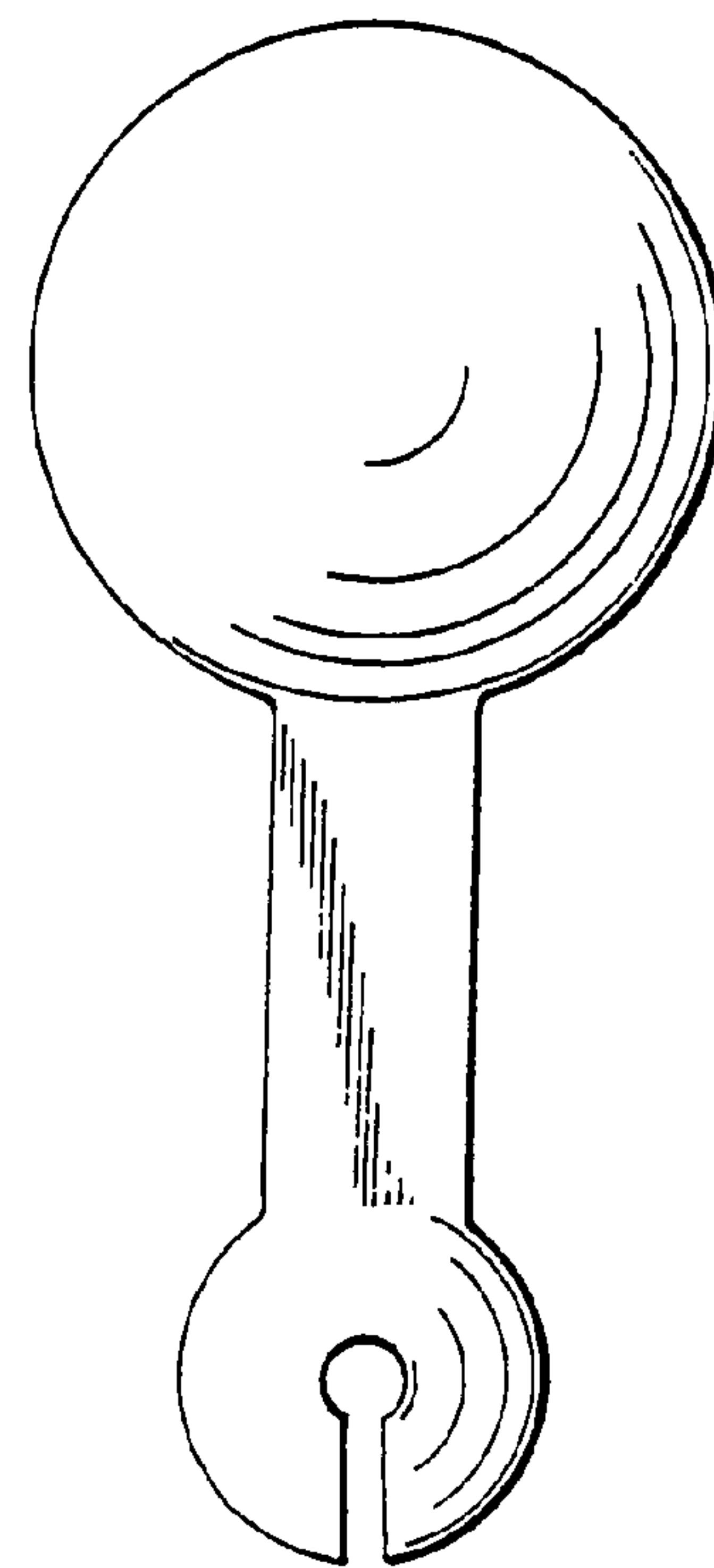

FIG. 16

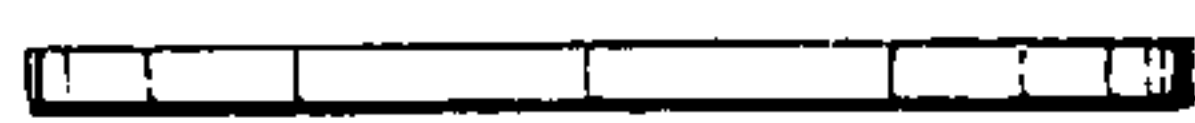

FIG. 17



FIG. 18

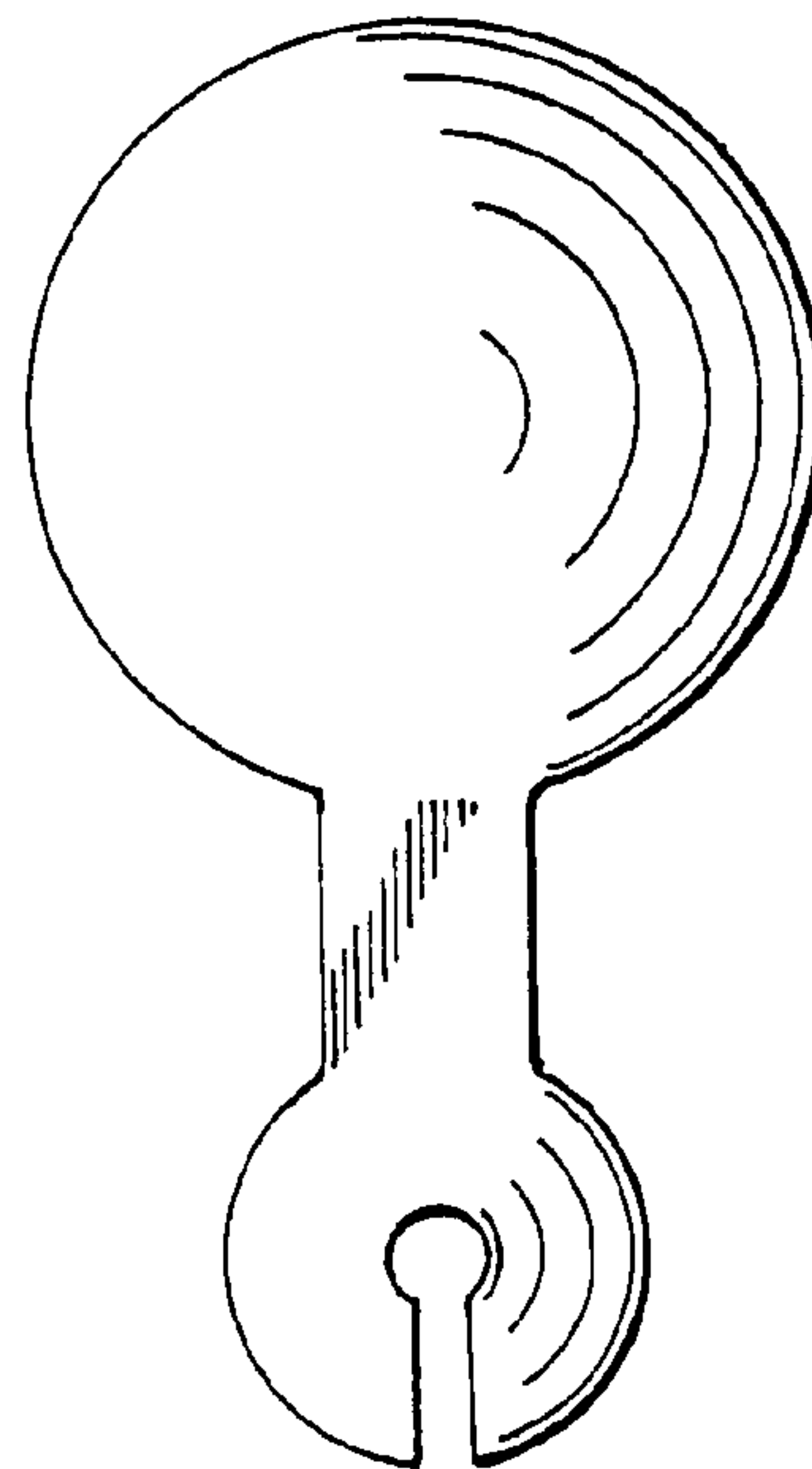
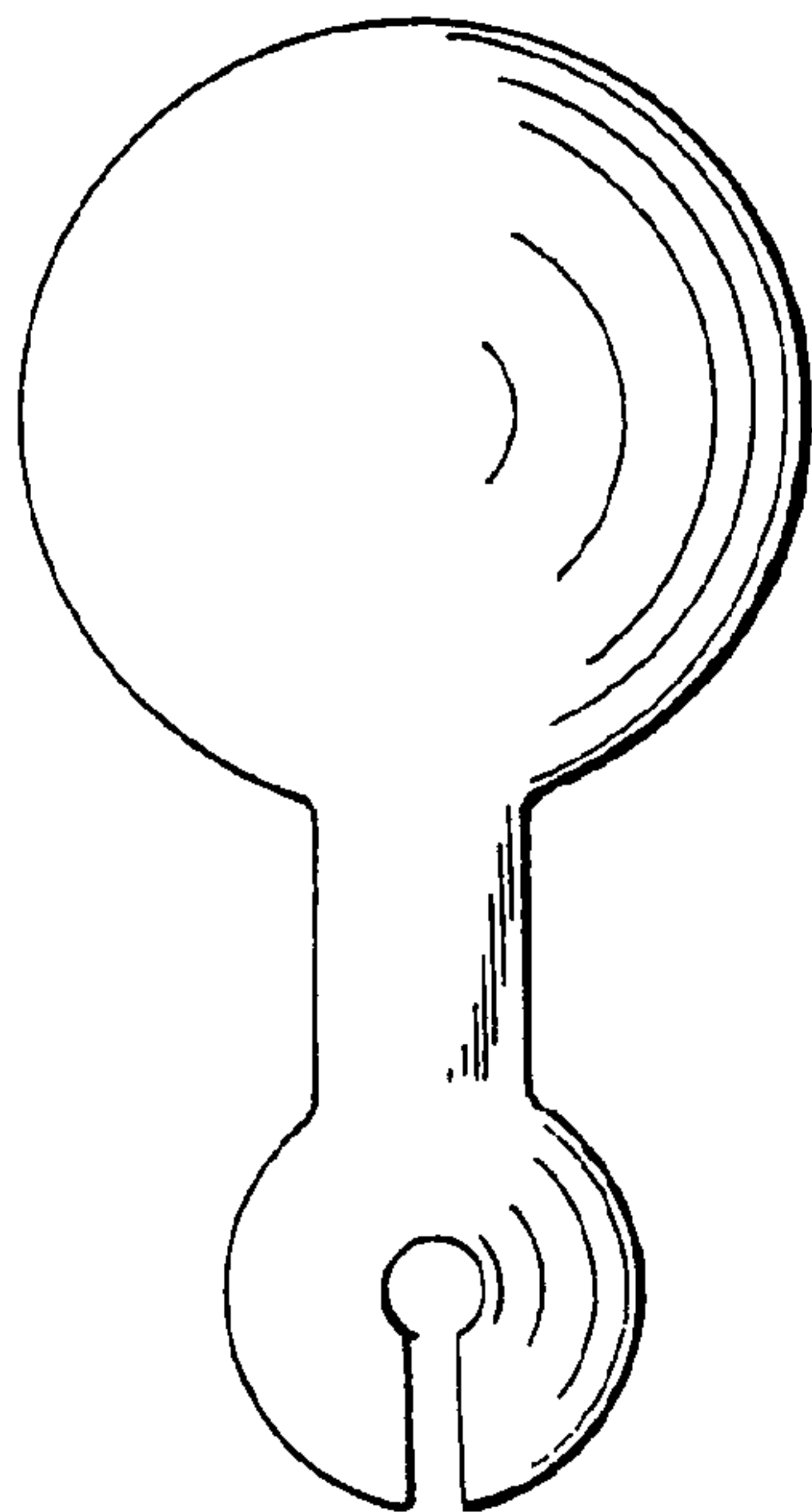
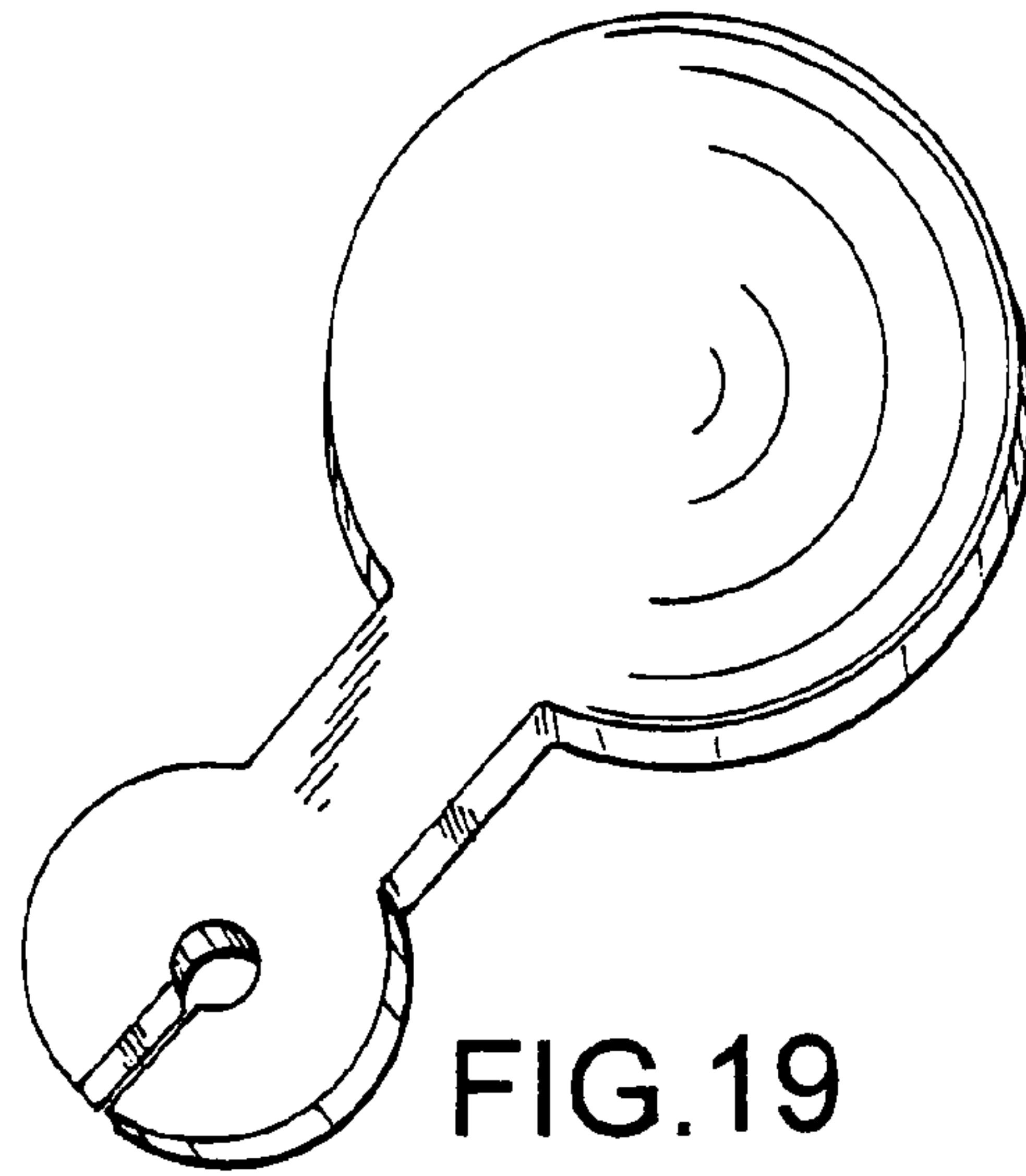

FIG. 20

FIG. 21

FIG. 22

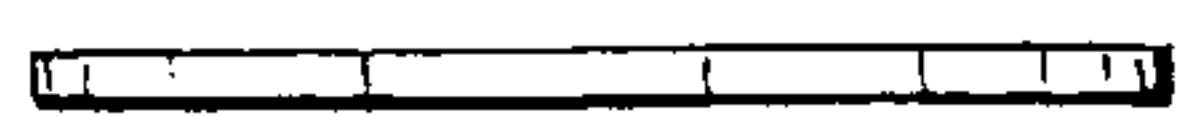

FIG. 23



FIG. 24