



US00D555623S

(12) **United States Design Patent**  
**Cho et al.**

(10) **Patent No.:** **US D555,623 S**

(45) **Date of Patent:** **\*\* Nov. 20, 2007**

(54) **MOBILE PHONE**

(75) Inventors: **Yoon-Young Cho**, Seoul (KR);  
**Chang-Soo Lee**, Incheon (KR)

(73) Assignee: **Samsung Electronics Co., Ltd.** (KR)

(\*\*) Term: **14 Years**

(21) Appl. No.: **29/263,867**

(22) Filed: **Jul. 31, 2006**

(30) **Foreign Application Priority Data**

May 18, 2006 (KR) ..... 30-2006-0018504

(51) **LOC (8) Cl.** ..... **14-03**

(52) **U.S. Cl.** ..... **D14/138**

(58) **Field of Classification Search** ..... D14/137,  
D14/138, 147, 218, 341-347, 496; 455/90.3,  
455/556.1, 556.2, 575.1, 575.3, 575.4; 379/433.01-433.13;  
361/814; 348/14.02

See application file for complete search history.

(56) **References Cited**

**U.S. PATENT DOCUMENTS**

D432,099 S *	10/2000	Loh et al. ....	D14/345
6,297,945 B1 *	10/2001	Yamamoto .....	361/681
D467,235 S *	12/2002	Hawkins et al. ....	D14/138
D479,215 S *	9/2003	Yokoyama .....	D14/138
D486,809 S *	2/2004	Hwang .....	D14/138
D502,703 S *	3/2005	Tsujimoto et al. ....	D14/346
D513,742 S *	1/2006	Arnholt et al. ....	D14/138
6,999,802 B2 *	2/2006	Kim .....	455/575.1
D519,486 S *	4/2006	Lee et al. ....	D14/138
D519,998 S *	5/2006	Park .....	D14/346
D520,483 S *	5/2006	Park et al. ....	D14/138
D525,225 S *	7/2006	Lee .....	D14/138
D526,300 S *	8/2006	Lee .....	D14/138
D527,365 S *	8/2006	Jang .....	D14/138
D534,144 S *	12/2006	Chung et al. ....	D14/138
D534,145 S *	12/2006	Lheem .....	D14/138

D534,515 S *	1/2007	Kim et al. ....	D14/138
D534,517 S *	1/2007	Cho et al. ....	D14/138
D534,888 S *	1/2007	Kim et al. ....	D14/138
D534,890 S *	1/2007	Kim .....	D14/138
D535,637 S *	1/2007	Park et al. ....	D14/138
D535,968 S *	1/2007	Lee .....	D14/138
D540,769 S *	4/2007	Lee et al. ....	D14/138
2004/0242288 A1 *	12/2004	Balle et al. ....	455/575.1
2005/0014538 A1 *	1/2005	Hyun et al. ....	455/575.4
2006/0205438 A1 *	9/2006	Jung .....	455/566

**OTHER PUBLICATIONS**

Motorola E680, announced 1<sup>st</sup> quarter 2004, [online], [retrieved on Feb. 16, 2007]. Retrieved from Internet ,<URL: <http://www.gsmarena.com>>.\*

(Continued)

*Primary Examiner*—Jeffrey Asch

*Assistant Examiner*—Bridget L Eland

(74) *Attorney, Agent, or Firm*—Cantor Colburn LLP

(57)

**CLAIM**

We claim, the ornamental design for a mobile phone, as shown and described.

**DESCRIPTION**

FIG. 1 is a top and front perspective view of a mobile phone, showing our new design;

FIG. 2 is a front elevational view thereof;

FIG. 3 is a rear elevational view thereof;

FIG. 4 is a left side elevational view thereof;

FIG. 5 is a right side elevational view thereof;

FIG. 6 is a top plan view thereof;

FIG. 7 is a bottom plan view thereof; and,

FIG. 8 is a top front perspective view thereof, with the display portion flipped to an alternate position.

**1 Claim, 6 Drawing Sheets**

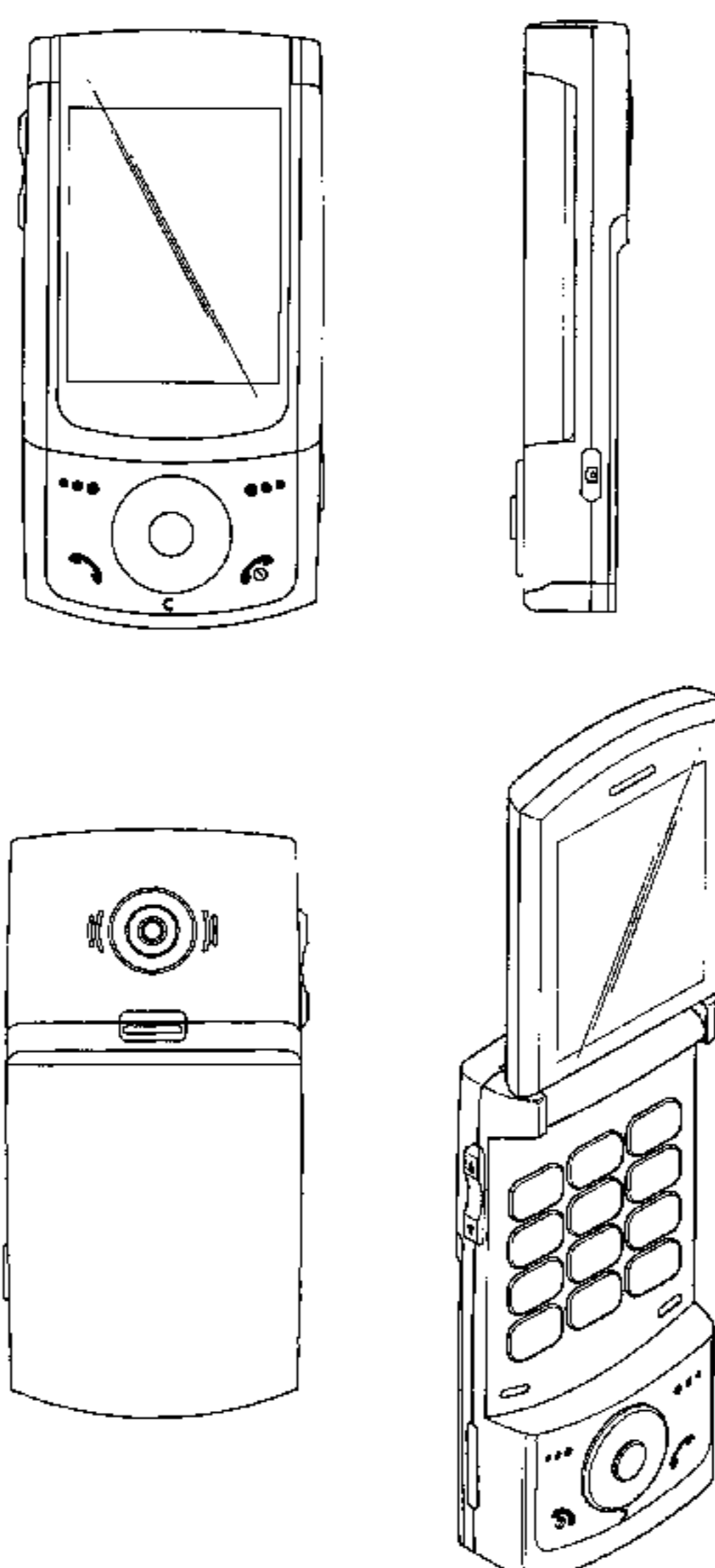

OTHER PUBLICATIONS

InnoStream INNO 55, announced 2<sup>nd</sup> quarter 2004, [online], [retrieved on Feb. 20, 2007]. Retrieved from Internet ,<URL: <http://www.gsmarena.com>>.\*

LG V9000, announced Feb. 2006, [online], [retrieved on Feb. 20, 2007]. Retrieved from Internet ,<URL: <http://www.gsmarena.com>>.\*

LG U900, announced Apr. 2006, [online], [retrieved on Feb. 20, 2007]. Retrieved from Internet ,<URL: <http://www.gsmarena.com>>.\*

Haier M80, announced 2<sup>nd</sup> quarter 2006, [online], [retrieved on Feb. 20, 2007]. Retrieved from Internet ,<URL: <http://www.gsmarena.com>>.\*

Motorola RIZR, announced Jul. 2006, [online], [retrieved on Feb. 16, 2007]. Retrieved from Internet ,<URL: <http://www.gsmarena.com>>.\*

Samsung Z650i, announced Oct. 2006, [online], [retrieved on Feb. 8, 2007]. Retrieved from Internet ,<URL: <http://www.gsmarena.com>>.\*

i-mate PDAL, announced Nov. 2006, [online], [retrieved on Feb. 20, 2007]. Retrieved from Internet ,<URL: <http://www.gsmarena.com>>.\*

\* cited by examiner

FIG. 1

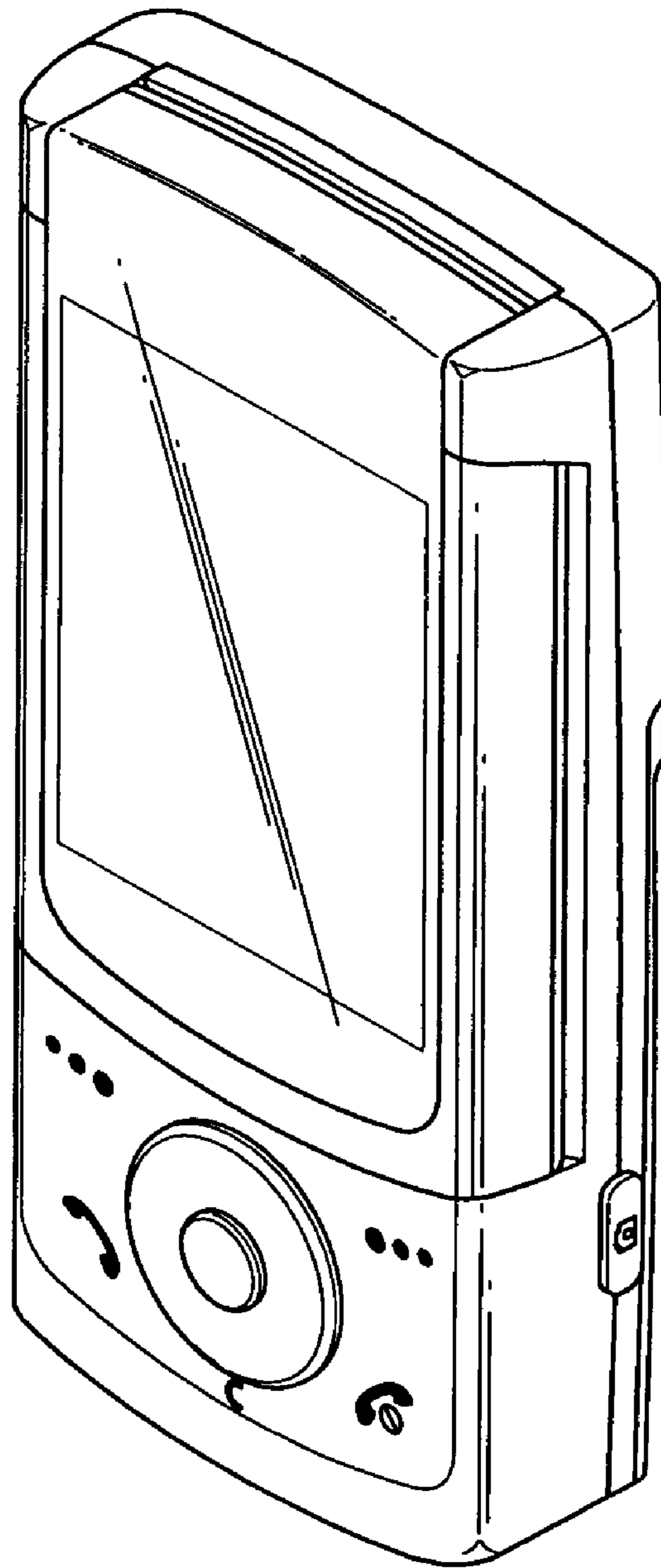

FIG. 2

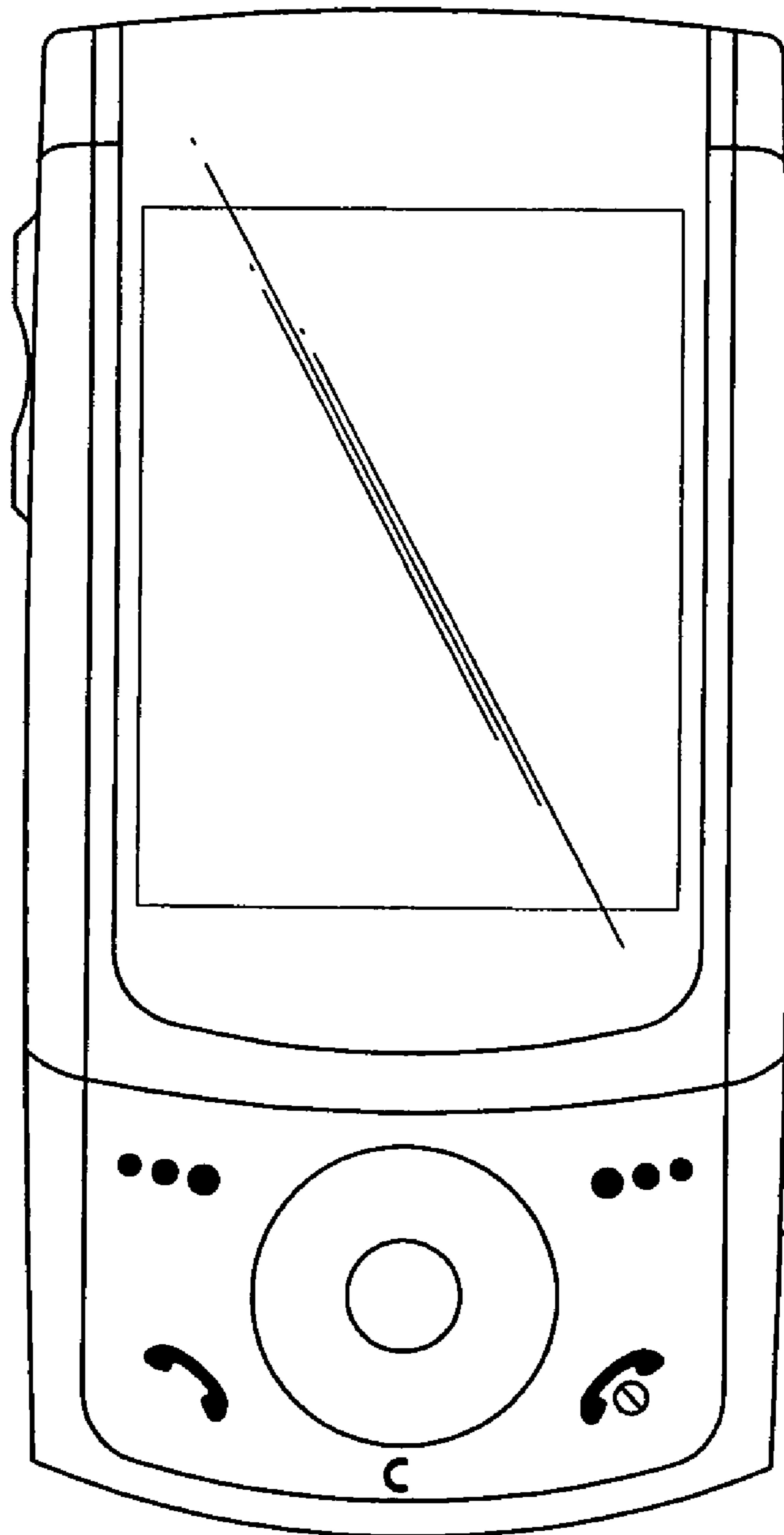

FIG. 3

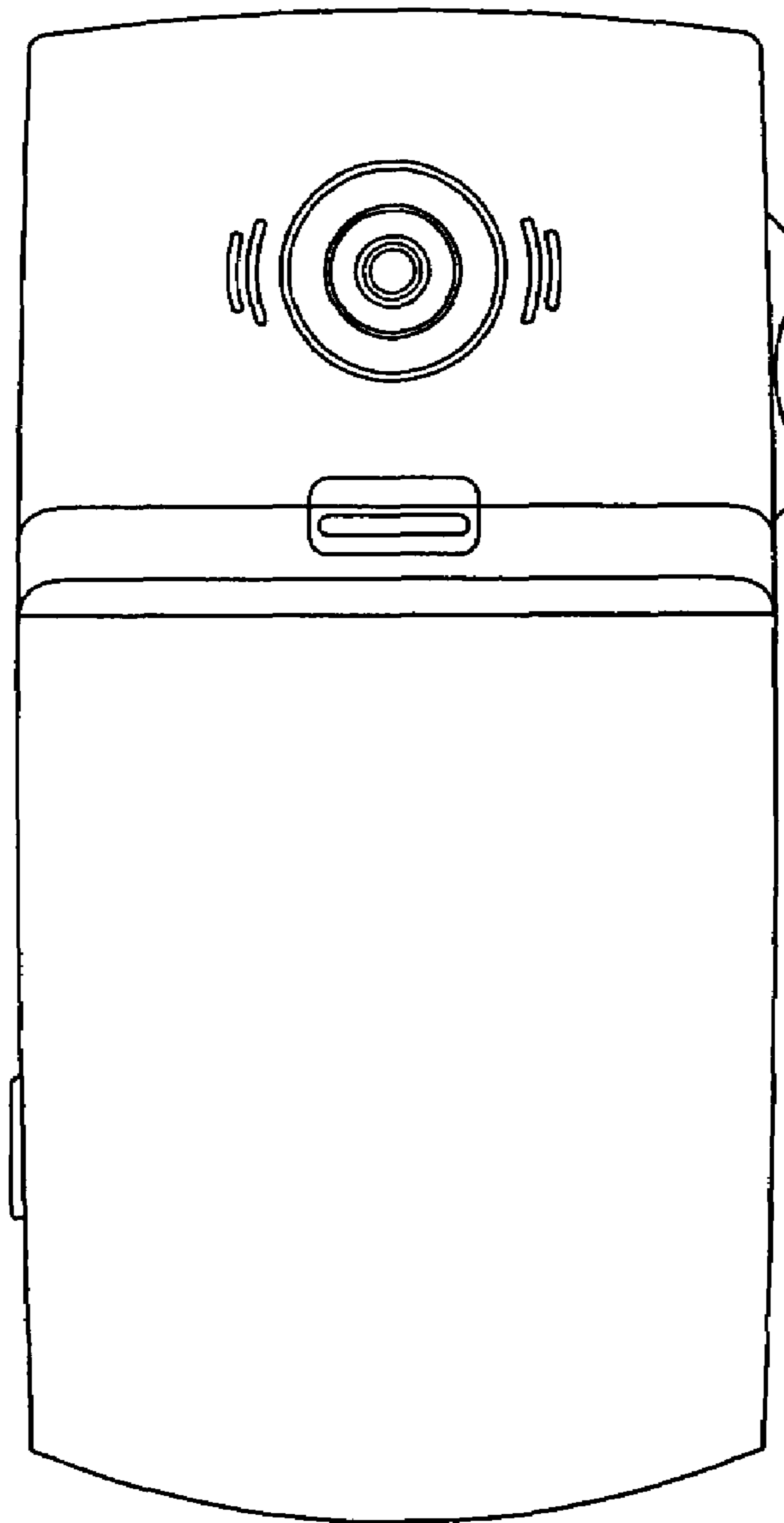

FIG. 4

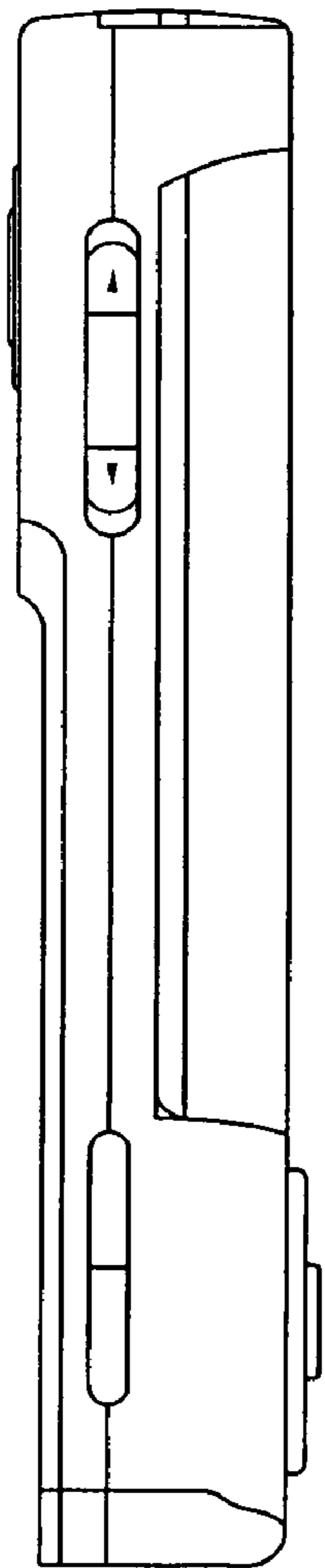

FIG. 5

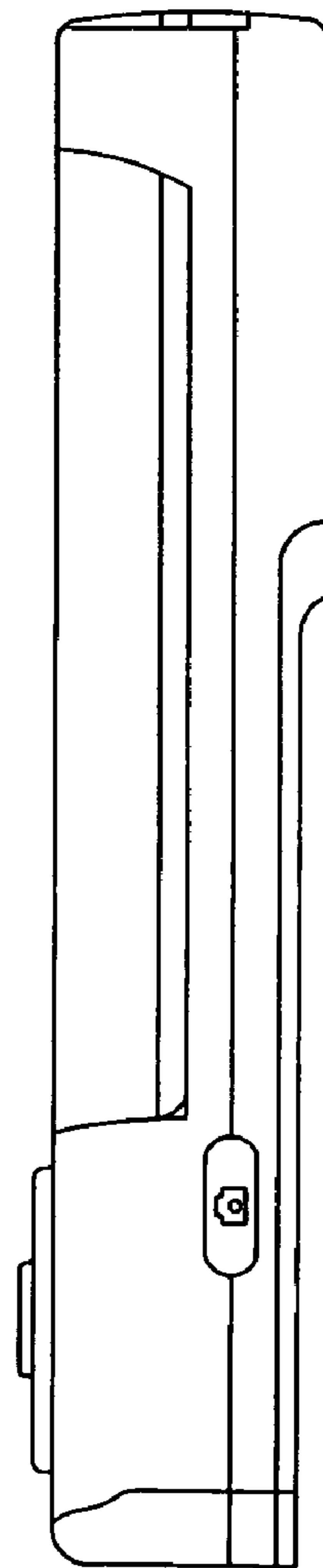

FIG. 6

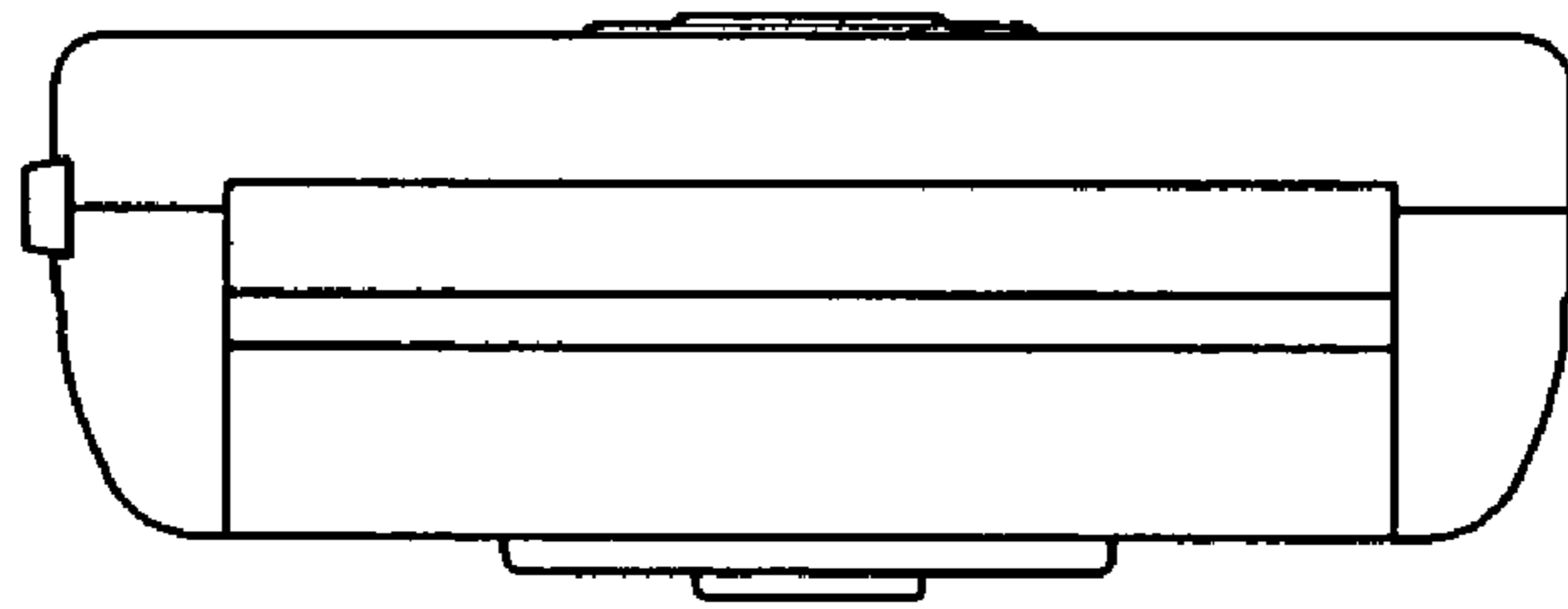

FIG. 7

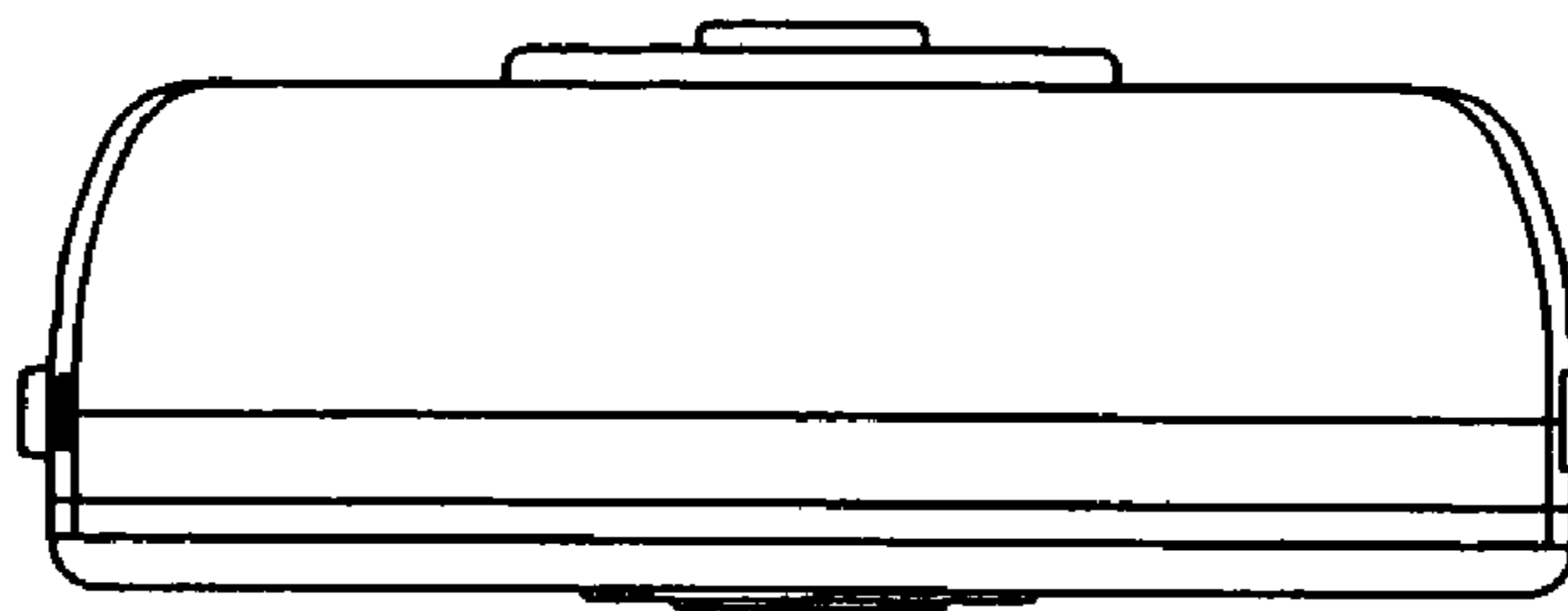

FIG. 8

