



US00D555619S

(12) **United States Design Patent**
Hong et al.

(10) **Patent No.:** **US D555,619 S**

(45) **Date of Patent:** **** Nov. 20, 2007**

(54) **PORTABLE PHONE**

(75) Inventors: **Kwan-Eui Hong**, Seoul (KR);
Bum-Soo Park, Kwangmyeong-si
(KR); **Nam-Mi Kim**, Seoul (KR);
Chang-Hwan Hwang, Goyang-Si (KR)

(73) Assignee: **Samsung Electronics Co., Ltd.**,
Suwon-Si (KR)

(**) Term: **14 Years**

(21) Appl. No.: **29/261,974**

(22) Filed: **Jun. 27, 2006**

(30) **Foreign Application Priority Data**

Dec. 28, 2005 (KR) 30-2005-0044299

(51) **LOC (8) Cl.** **14-03**

(52) **U.S. Cl.** **D14/138**

(58) **Field of Classification Search** D14/137,
D14/138, 147, 218, 341-347, 496; 455/90.3,
455/556.1, 556.2, 575.1, 575.3, 575.4; 379/433.01-433.13;
361/814; 348/14.02

See application file for complete search history.

(56) **References Cited**

U.S. PATENT DOCUMENTS

D469,367 S *	1/2003	Mirabelli et al.	D10/65
D479,215 S *	9/2003	Yokoyama	D14/138
D506,988 S *	7/2005	Oh	D14/138
D509,814 S *	9/2005	Shin et al.	D14/138
D515,060 S *	2/2006	Lee et al.	D14/138
D525,225 S *	7/2006	Lee	D14/138
D525,611 S *	7/2006	Jang	D14/138
D525,959 S *	8/2006	Kim et al.	D14/138
D526,297 S *	8/2006	Lee et al.	D14/138
D526,987 S *	8/2006	Lee et al.	D14/138
D527,365 S *	8/2006	Jang	D14/138
D527,716 S *	9/2006	Kim et al.	D14/138
D528,533 S *	9/2006	Lee et al.	D14/138
D529,475 S *	10/2006	Lee et al.	D14/138
D530,299 S *	10/2006	Lee	D14/138

D530,300 S *	10/2006	Cha et al.	D14/138
D531,973 S *	11/2006	Kim et al.	D14/138
D531,975 S *	11/2006	Kim et al.	D14/138
D534,144 S *	12/2006	Chung et al.	D14/138
D534,515 S *	1/2007	Kim et al.	D14/138
D535,272 S *	1/2007	Kim et al.	D14/138
D535,966 S *	1/2007	Lee et al.	D14/138
2005/0107126 A1 *	5/2005	Kim	455/565
2005/0124394 A1 *	6/2005	Kim et al.	455/575.3
2006/0154703 A1 *	7/2006	Kim	455/575.4
2007/0071232 A1 *	3/2007	Chung	379/433.07

OTHER PUBLICATIONS

Sagem SG 321i, announced 1st quarter 2004, [online], [retrieved on Feb. 20, 2007]. Retrieved from Internet ,<URL: <http://www.gsmarena.com>>.*

InnoStream INNO 55, announced 2nd quarter 2004, [online], [retrieved on Feb. 20, 2007]. Retrieved from Internet ,<URL: <http://www.gsmarena.com>>.*

(Continued)

Primary Examiner—Jeffrey Asch

Assistant Examiner—Bridget L Eland

(74) *Attorney, Agent, or Firm*—Staas & Halsey LLP

(57) **CLAIM**

The ornamental design for the portable phone, as shown and described.

DESCRIPTION

FIG. 1 is a perspective view of the portable phone showing our design;

FIG. 2 is a front view thereof;

FIG. 3 is a rear view thereof;

FIG. 4 is a left side view thereof;

FIG. 5 is a right side view thereof;

FIG. 6 is a top plan view thereof;

FIG. 7 is a bottom plan view thereof; and,

FIG. 8 is a front, open view thereof.

1 Claim, 5 Drawing Sheets

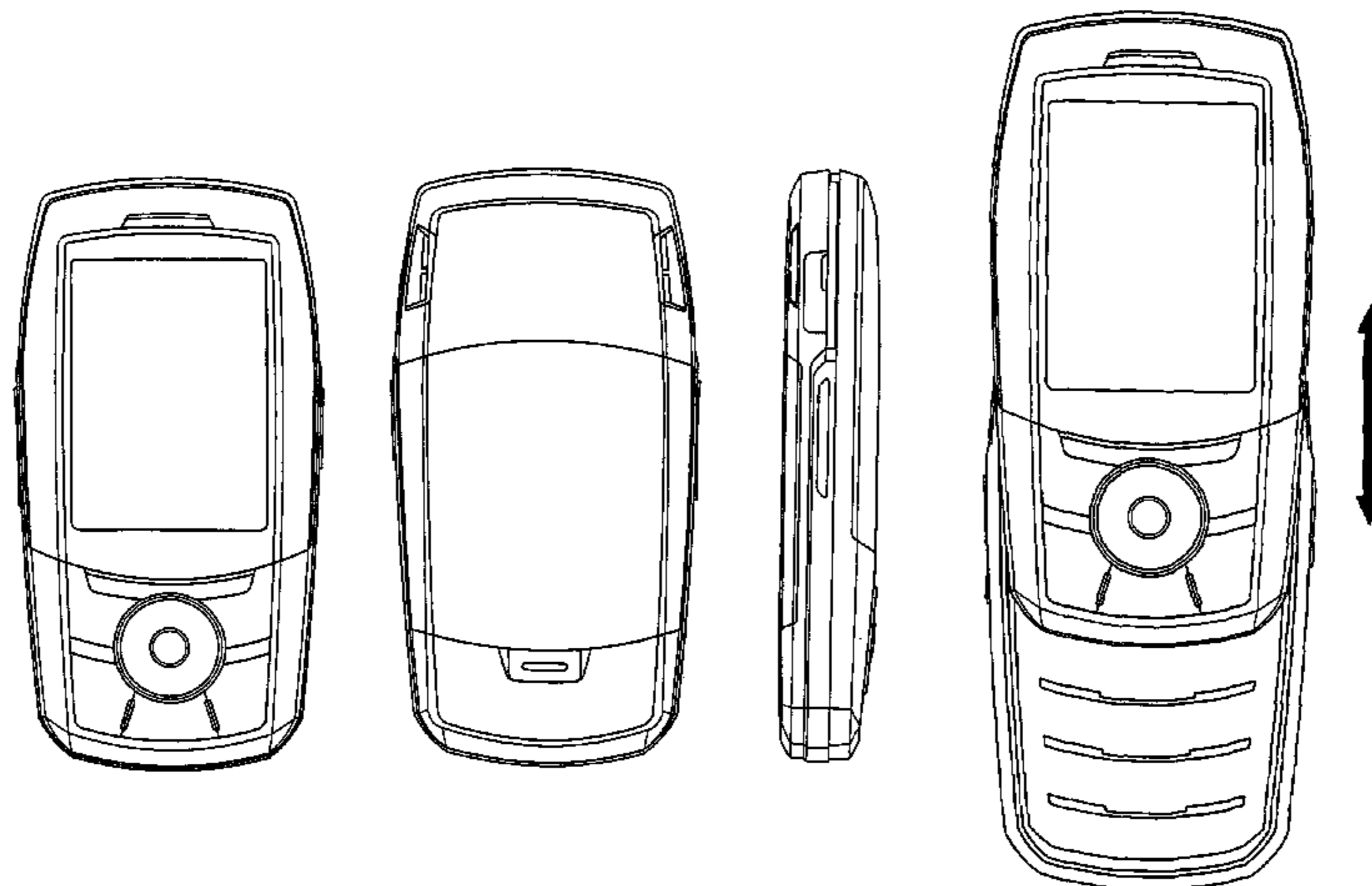

OTHER PUBLICATIONS

Samsung E880, announced 1st quarter 2004, [online], [retrieved on Feb. 8, 2007]. Retrieved from Internet ,<URL: <http://www.gsmarena.com>>.*

LG S5200, announced Oct. 2005, [online], [retrieved on Feb. 20, 2007]. Retrieved from Internet ,<URL: <http://www.gsmarena.com>>.*

Pantech PG-1600, announced Jun. 2006, [online], [retrieved on Feb. 20, 2007]. Retrieved from Internet ,<URL: <http://www.gsmarena.com>>.*

Pantech PU-5000, announced Jun. 2006, [online], [retrieved on Feb. 20, 2007]. Retrieved from Internet ,<URL: <http://www.gsmarena.com>>.*

Samsung X530, announced Oct. 2006, [online], [retrieved on Feb. 8, 2007]. Retrieved from Internet ,<URL: <http://www.gsmarena.com>>.*

Samsung E890, announced Oct. 2006, [online], [retrieved on Feb. 8, 2007]. Retrieved from Internet ,<URL: <http://www.gsmarena.com>>.*

* cited by examiner

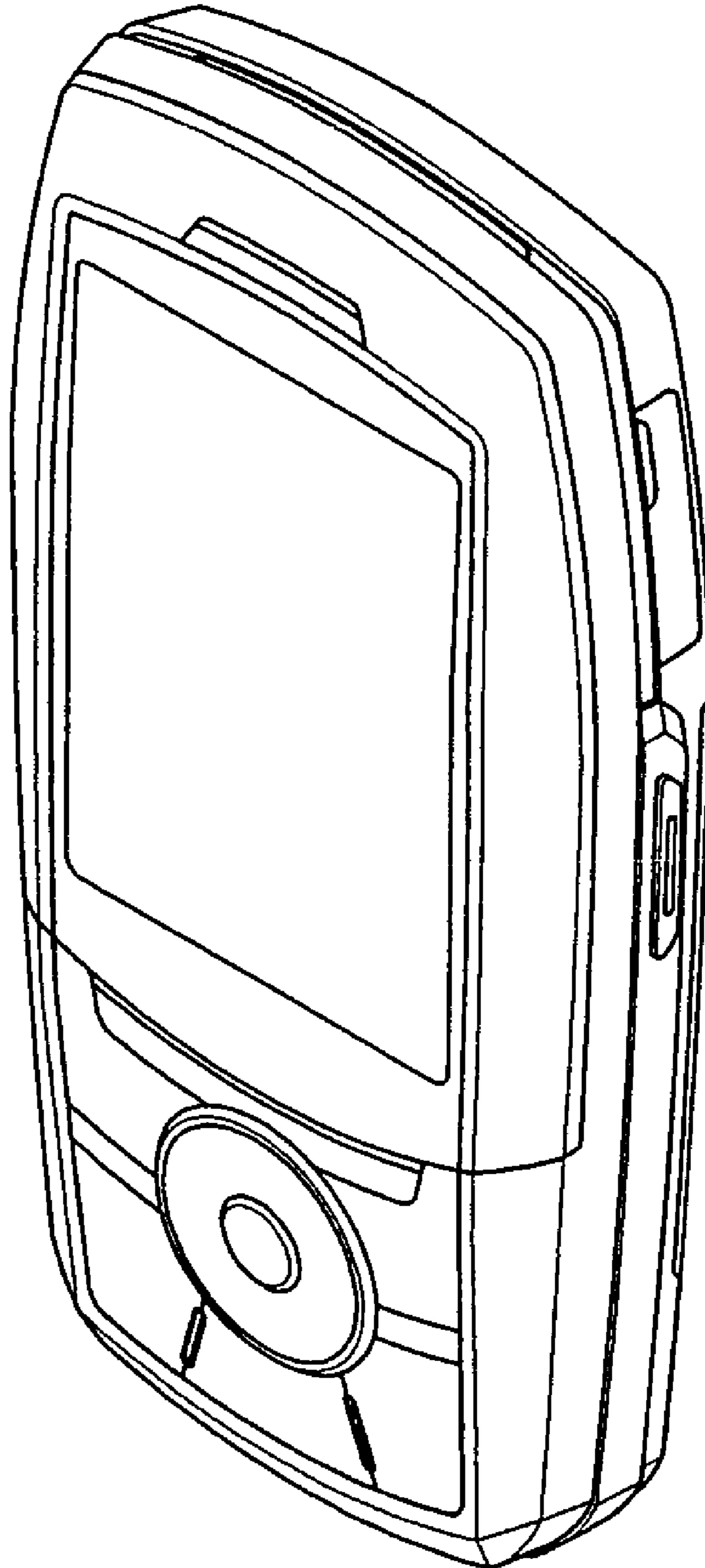

FIGURE 1

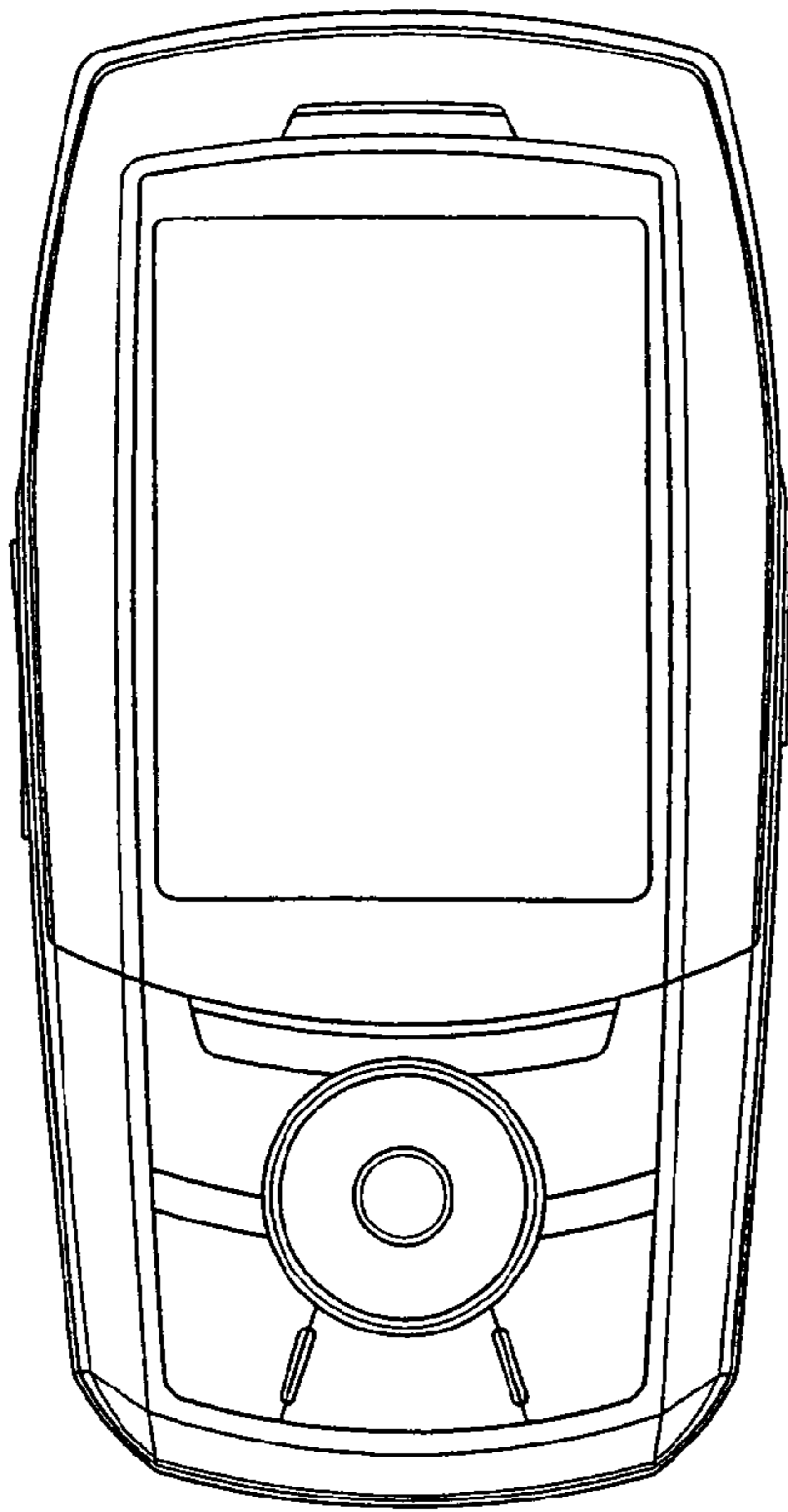

FIGURE 2

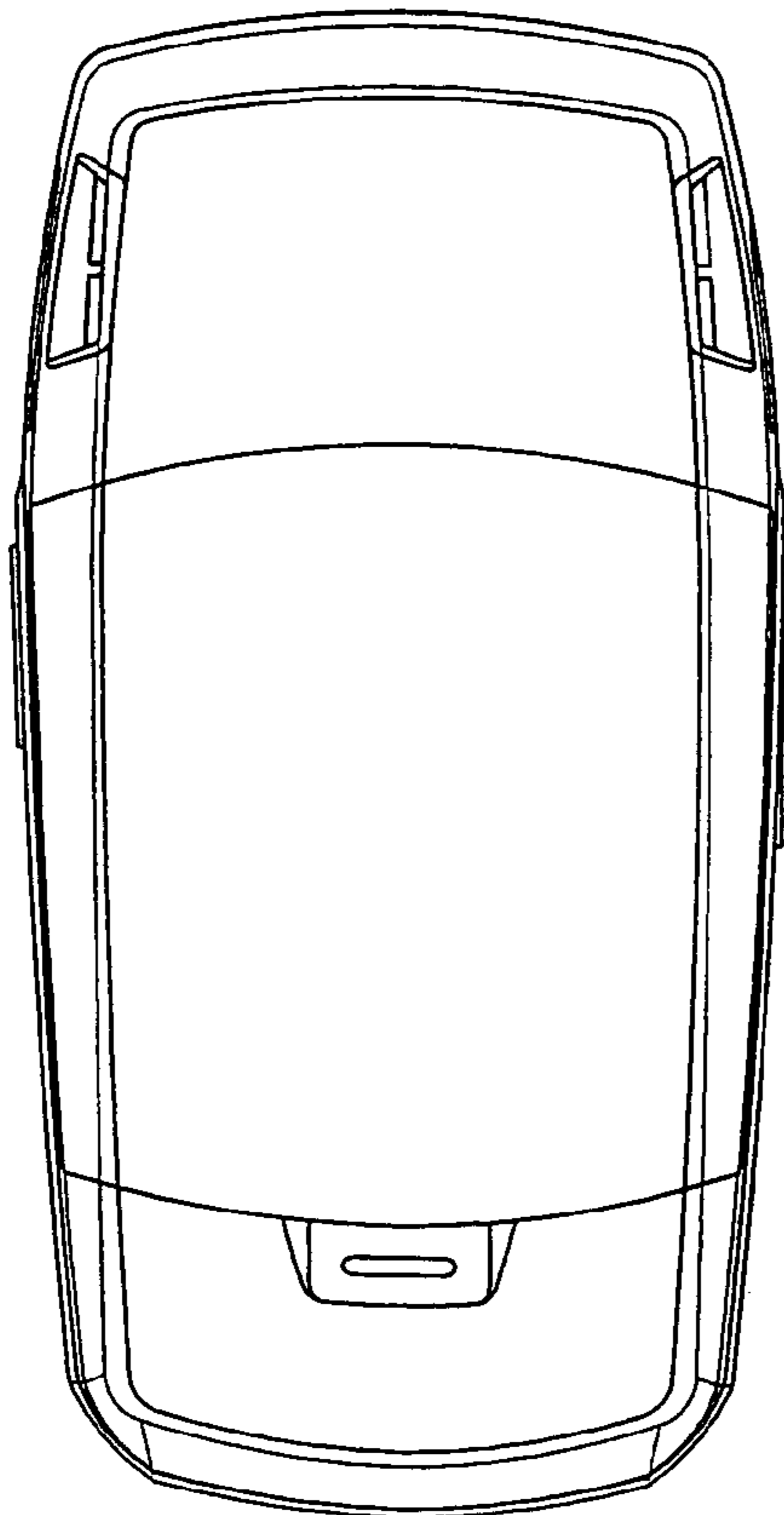

FIGURE 3

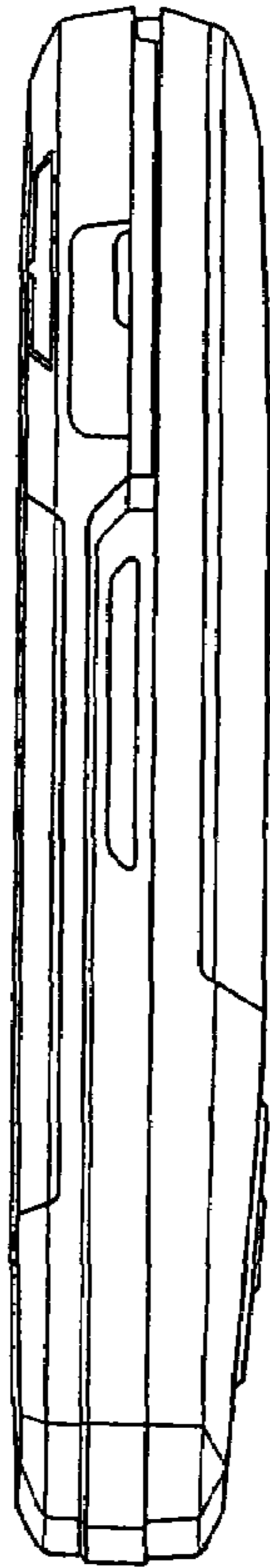

FIGURE 4

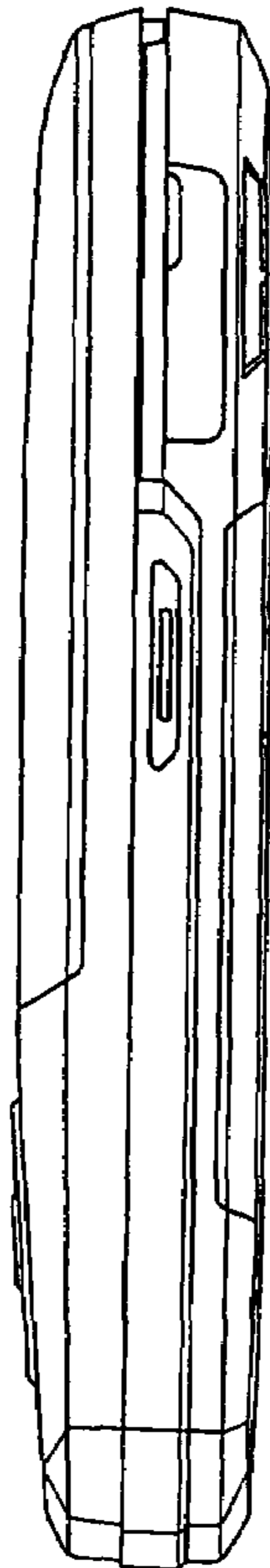

FIGURE 5

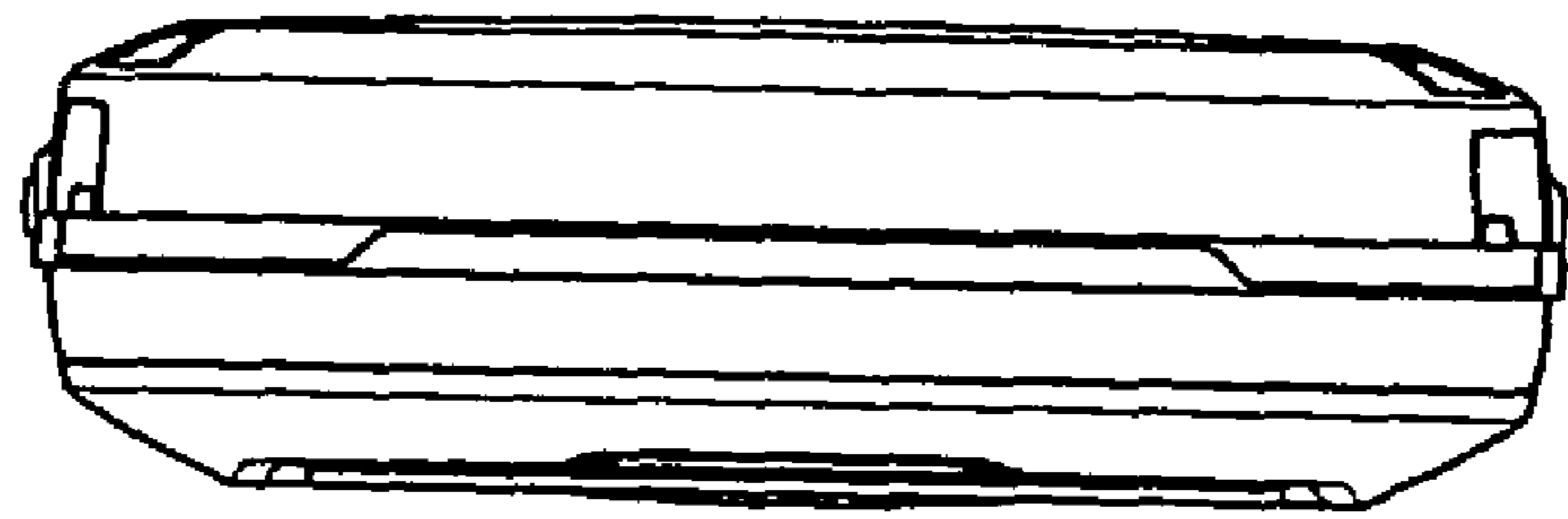

FIGURE 6

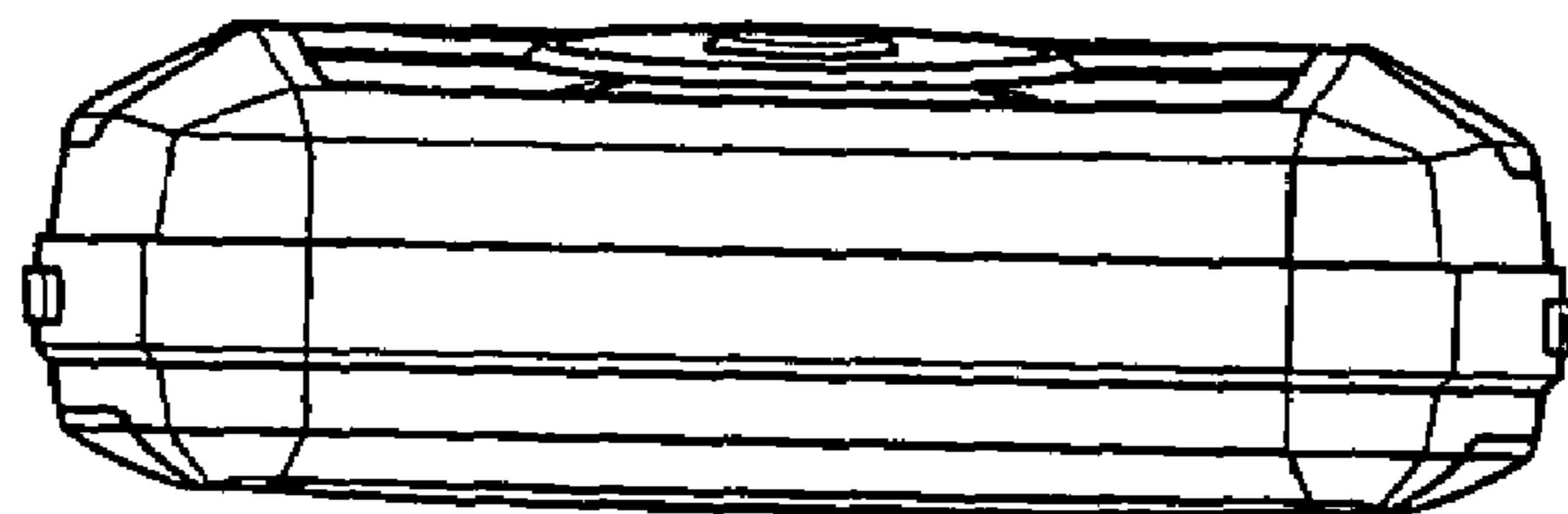

FIGURE 7

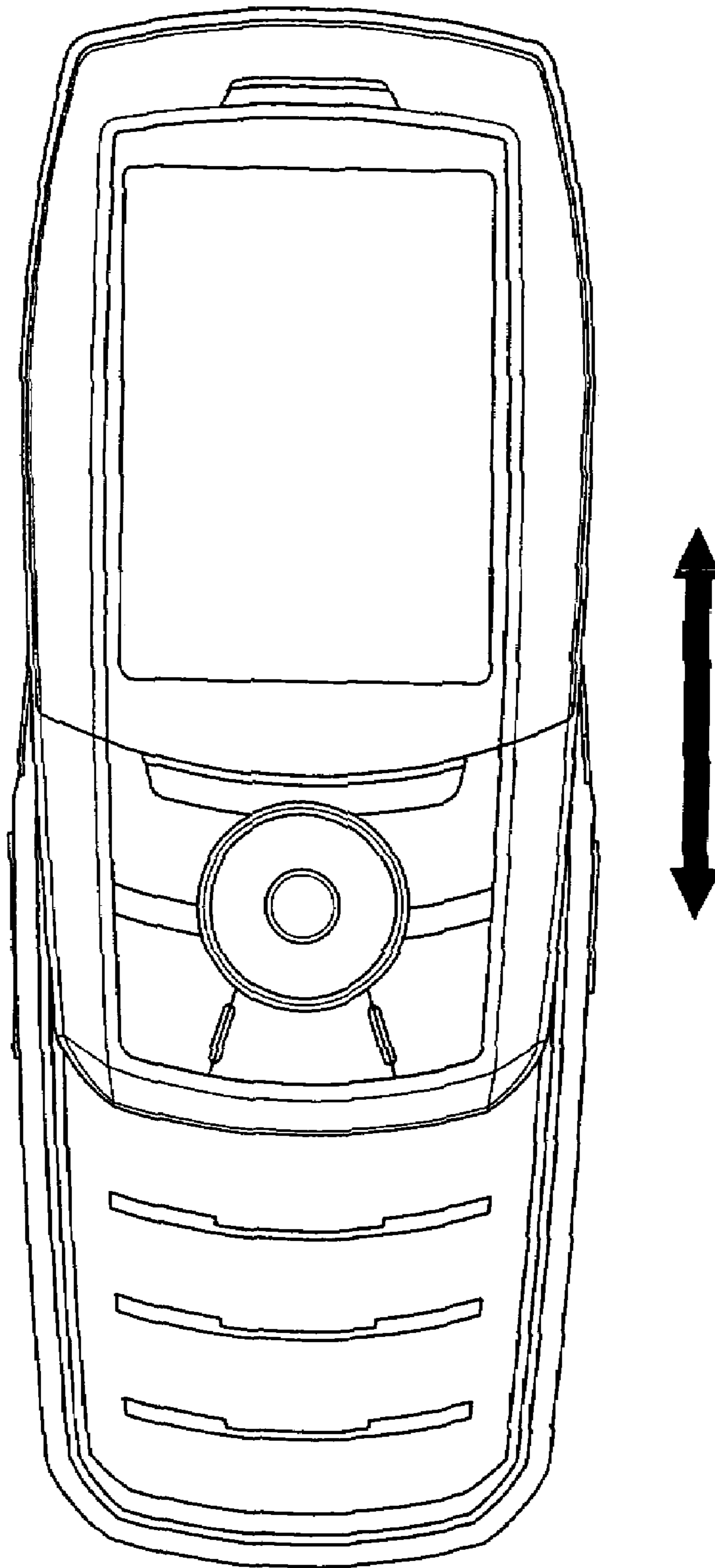

FIGURE 8